

---

## 3.5A Step-Down PWM Switch-Mode DC/DC Converter

### Features

- Continuous Output Current: 3.5A
- Stable with Low ESR Output Ceramic Capacitors
- Thermal Shutdown
- Cycle-by-Cycle Over Current Protection
- Wide 5V to 16V Operating Input Range
- Output Adjustable from 1.2V to 16V
- Available in 8 pin SO package
- Frequency: up to 400kHz

### Applications

- Battery Charger
- Distributed Power Systems
- Pre-Regulator for Linear Regulators

### Description

The HM1583A is a step down switch mode converter with a built in power MOSFET. It achieves 3.5A continuous output current over a wide input supply range with excellent load and line regulation.

Current mode operation provides fast transient response and eases loop stabilization.

Fault condition protection includes cycle-by-cycle current limiting and thermal shutdown.

The HM1583A requires a minimum number of readily available standard external components.

### Order Information

HM1583A – ① ②:

SYMBOL	DESCRIPTION
①	Denotes Output Voltage: A: Adjustable Output Voltage;
②	Denotes Package Types: G: SOP-8L

## Typical Application Circuit

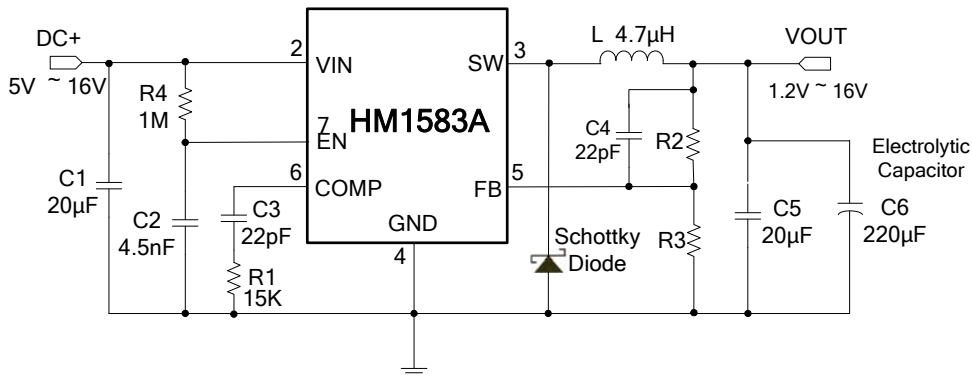

$$*V_{OUT} = 0.8V \cdot [1 + (R2/R3)].$$

## Pin Assignment and Description

TOP VIEW		PIN	NAME	DESCRIPTION
		1,8	N/C	No Connect
		2	VIN	Input
		3	SW	Switch Node
		4	GND	Ground
		5	FB	Feedback
		6	COMP	Optional External Compensation
		7	EN	ON/OFF Control(High Enable)

## Absolute Maximum Ratings (Note 1)

- VIN Pin Voltage.....-0.3V ~ 20V
- SW Pin Voltage.....-0.3V ~ (VIN + 0.3)V
- FB Pin Voltage.....-0.3V ~ 6V
- Operating Temperature Range(Note 2) .....-40°C ~ + 85°C
- Storage Temperature Range .....-65°C ~ + 150°C
- Junction Temperature Range.....-40°C ~ +125°C
- Lead Temperature (Soldering 10, sec.) .....+ 265°C

**Note 1:** Stresses listed as the above "Absolute Maximum Ratings" may cause permanent damage to the device. Exposure to absolute maximum rating conditions for extended periods may remain possibility to affect device reliability.

**Note 2:** The HM1583A is guaranteed to meet performance specifications from 0°C to 70°C. Specifications over the -40°C to 85°C operating temperature range are assured by design, characterization and correlation with statistical process controls.

## Electrical Characteristics

Operating Conditions:  $T_A=25^{\circ}\text{C}$ ,  $V_{IN}=6\text{V}$ , unless otherwise specified.

SYMBOL	PARAMETER	CONDITIONS	MIN	TYP	MAX	UNITS
$V_{IN}$	Input Voltage Range		5		16	V
$V_{OUT}$	Output Voltage		1.2		16	V
$I_Q$	Quiescent Current	$V_{OUT} = 5\text{V}$ , $I_{LOAD} = 0\text{A}$		790		$\mu\text{A}$
$I_{OFF}$	Shutdown Current	$V_{EN} = 0\text{V}$ , $V_{IN} = 12\text{V}$		45.5		$\mu\text{A}$
$V_{FB}$	Feedback Voltage	$T_A = 25^{\circ}\text{C}$	0.776	0.8	0.824	V
$f_{OSC}$	Oscillator Frequency	$V_{OUT} = 5\text{V}$ , $I_{OUT} = 100\text{mA}$		400		kHz
EFFI	Efficiency	When connected to extra components, $V_{IN} = 9\text{V}$ , $V_{OUT} = 5\text{V}$ , $I_{OUT} = 1\text{A}$		92		%

## Typical Performance Characteristics

Operating Conditions:  $T_A=25^\circ\text{C}$ , unless otherwise specified.

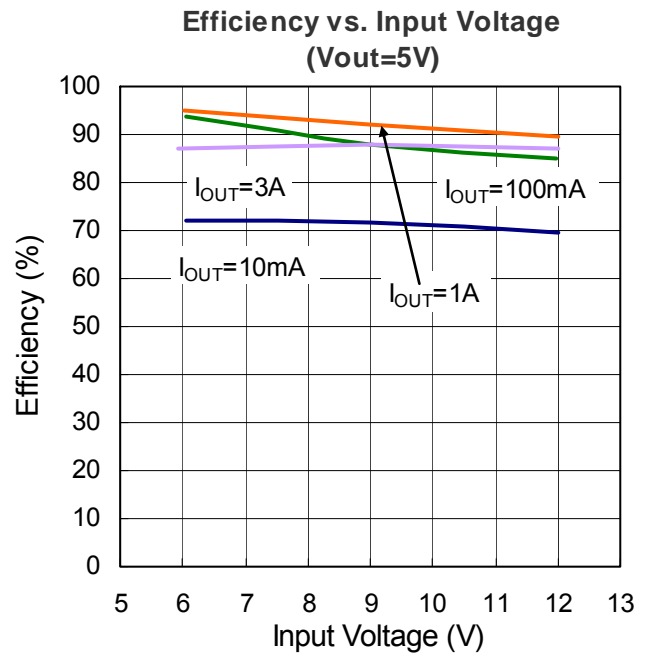
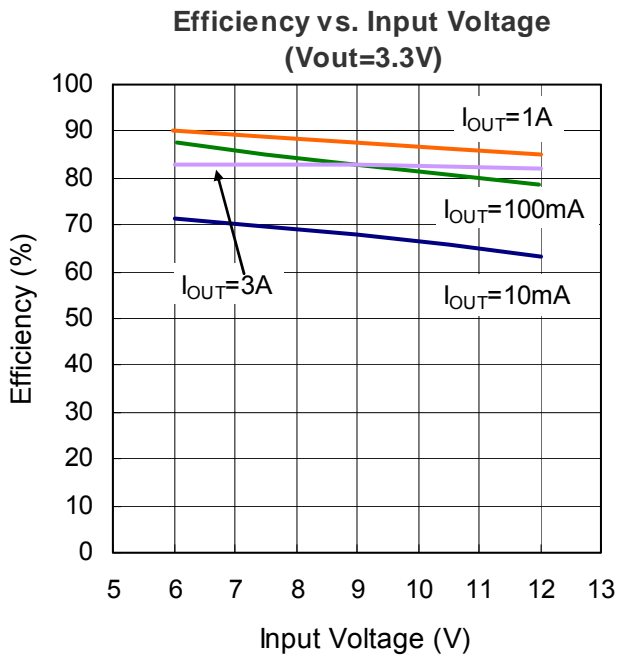
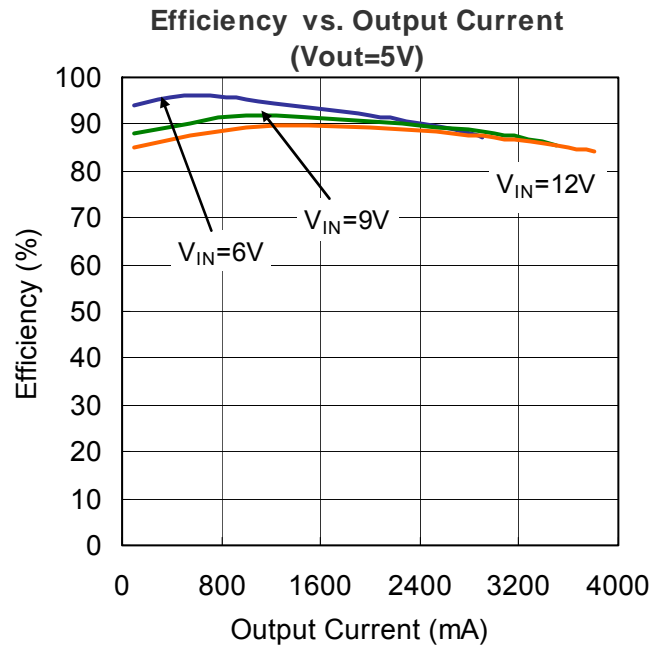
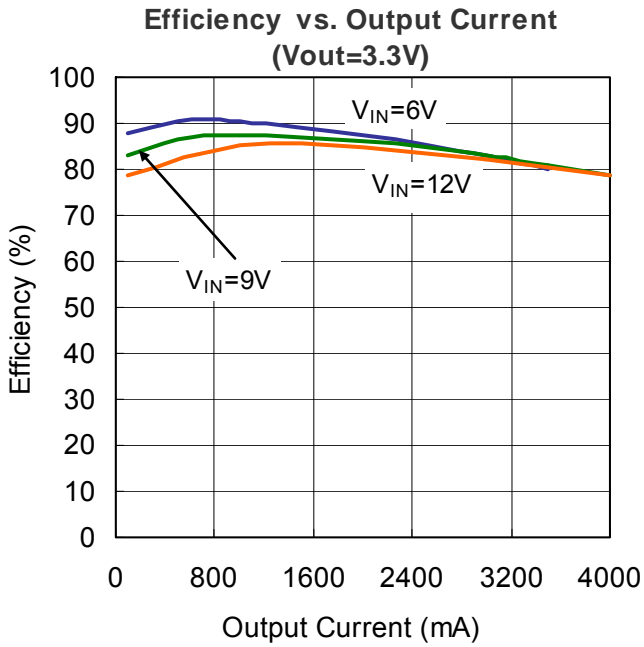

**Output Voltage vs. Load Current**  
 (Vin=12V, Vout=3.3V)

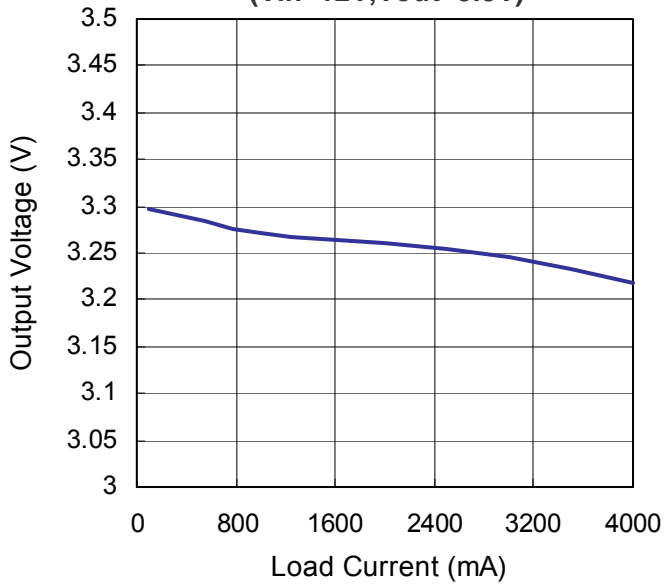

**Output Voltage vs. Load Current**  
 (Vin=12V, Vout=5V)

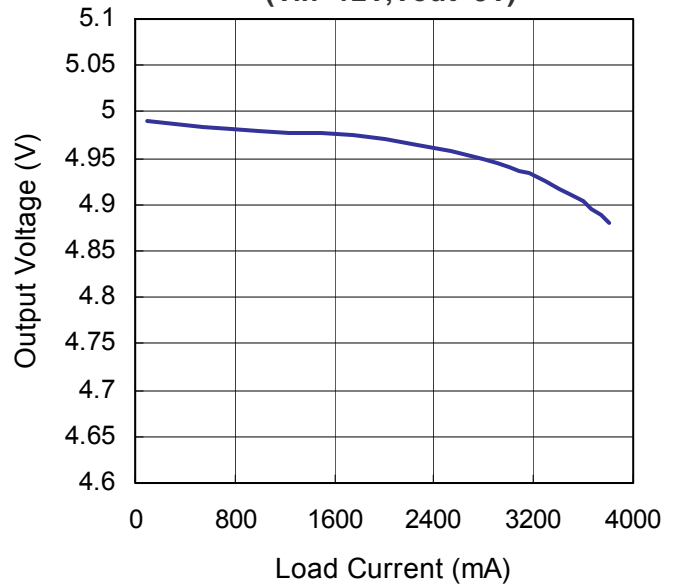

**Supply Current vs. Supply Voltage**  
 (Vout=3.3V Io=0A)

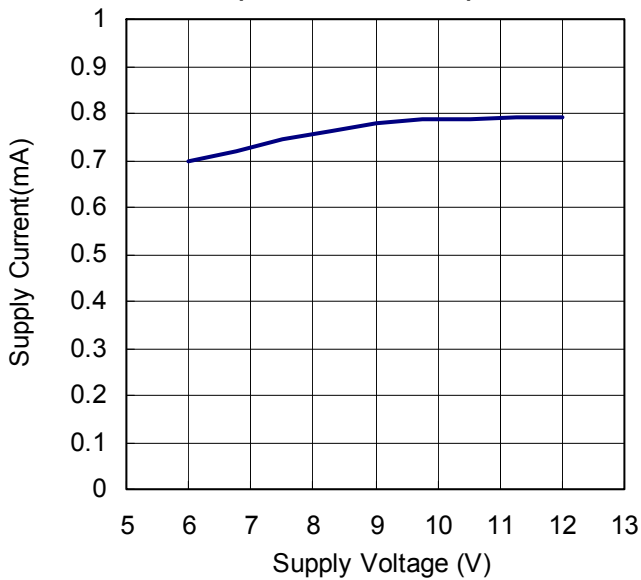

**Supply Current vs. Supply Voltage**  
 (Vout=5V Io=0A)

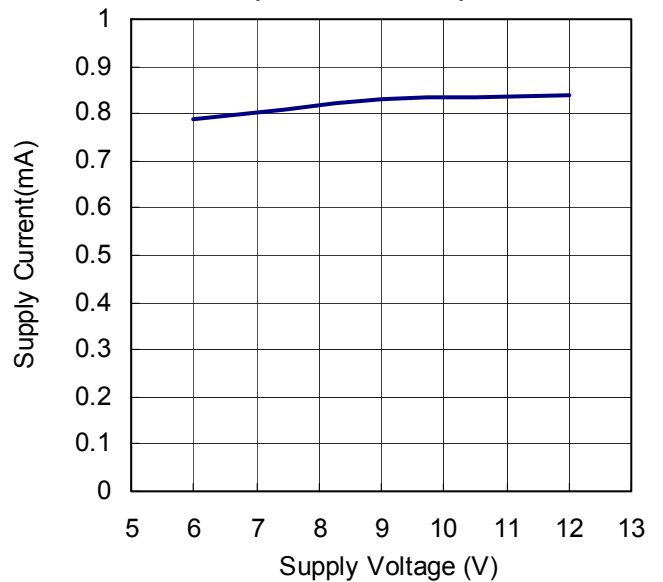

Start-up from Shutdown ( $V_{IN}=9V$ )

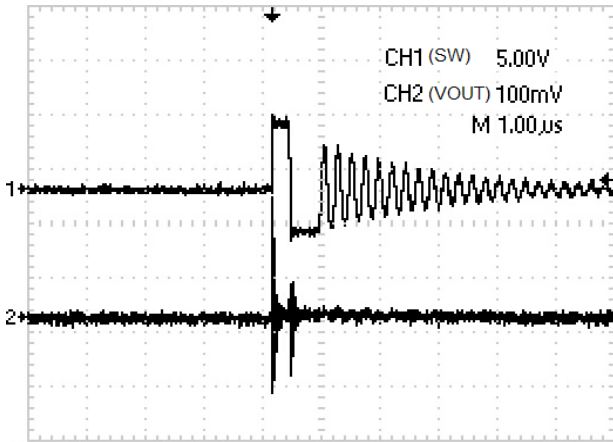

Start-up from Shutdown ( $V_{IN}=12V$ )

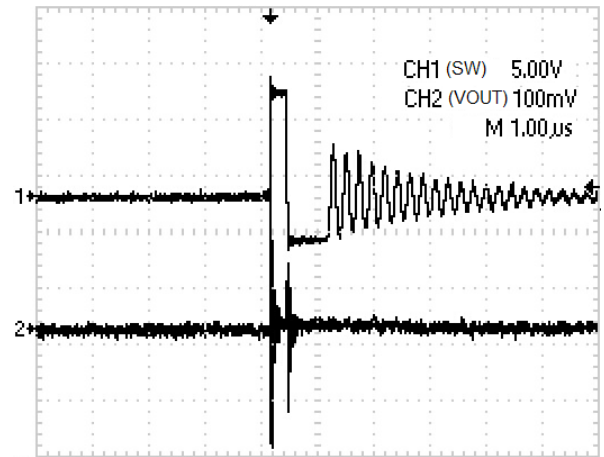

Output Noise ( $V_{IN}=9V, V_{OUT}=3.3V, I_{LOAD}=1A$ )

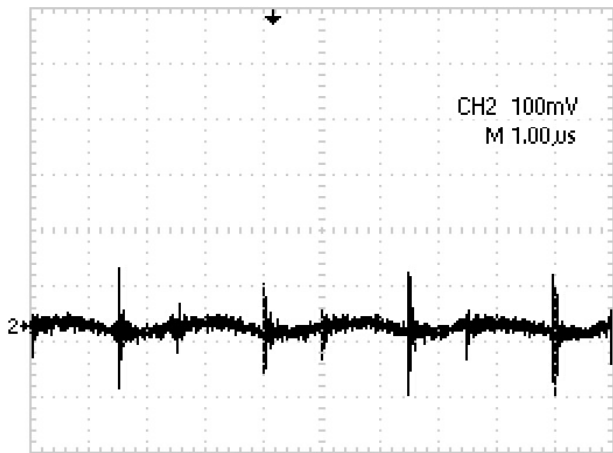

SW ( $V_{IN}=9V, V_{OUT}=3.3V, I_{LOAD}=1A$ )

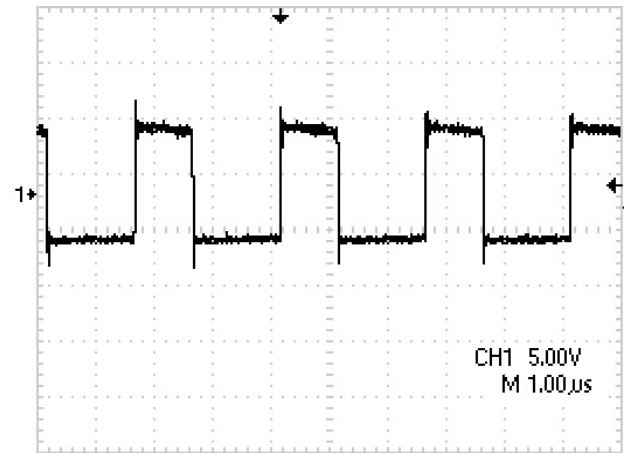

Output Noise ( $V_{IN}=12V, V_{OUT}=3.3V, I_{LOAD}=1A$ )

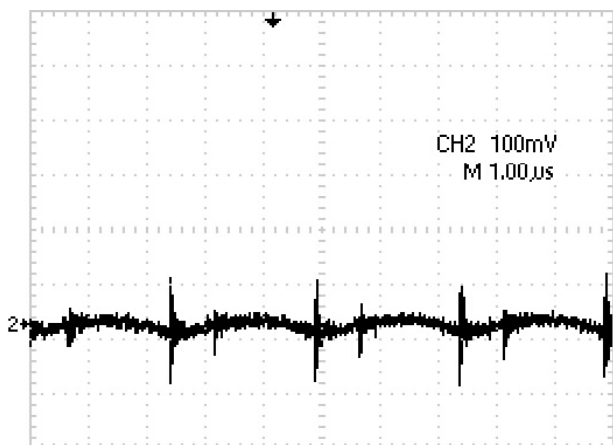

SW ( $V_{IN}=12V, V_{OUT}=3.3V, I_{LOAD}=1A$ )

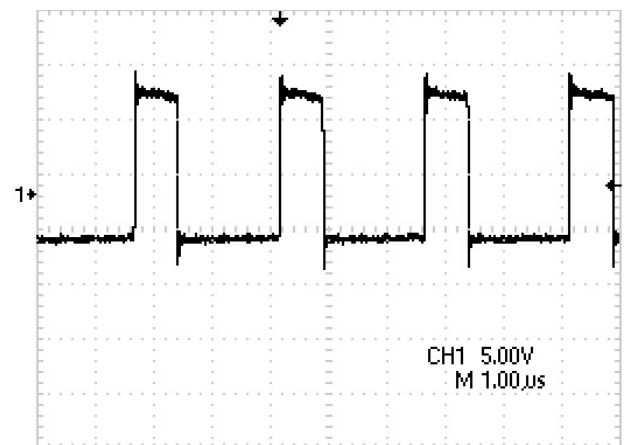

Start-up from Shutdown ( $V_{IN}=9V$ )

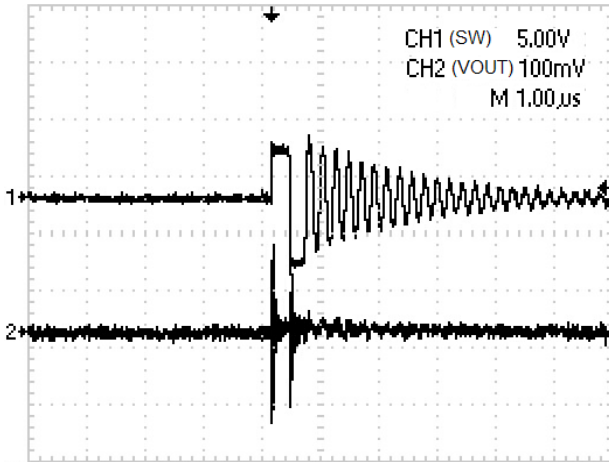

Start-up from Shutdown ( $V_{IN}=12V$ )

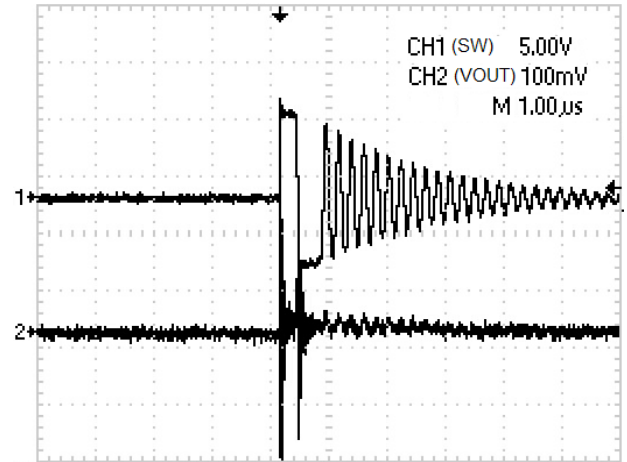

Output Noise ( $V_{IN}=9V, V_{OUT}=3.3V, I_{LOAD}=1A$ )

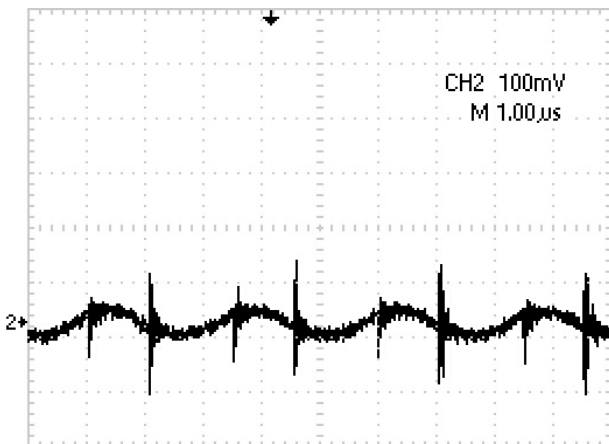

SW ( $V_{IN}=9V, V_{OUT}=3.3V, I_{LOAD}=1A$ )

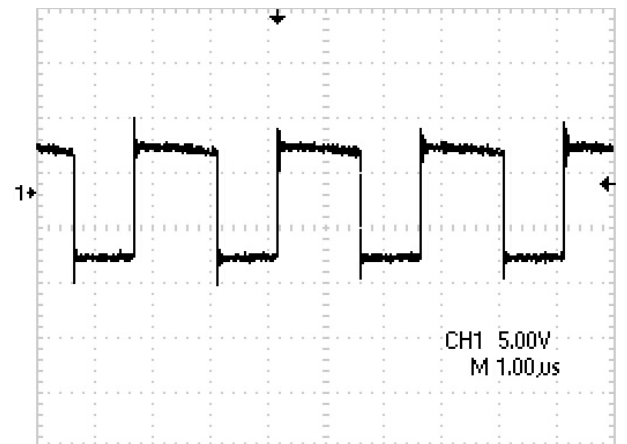

Output Noise ( $V_{IN}=12V, V_{OUT}=3.3V, I_{LOAD}=1A$ )

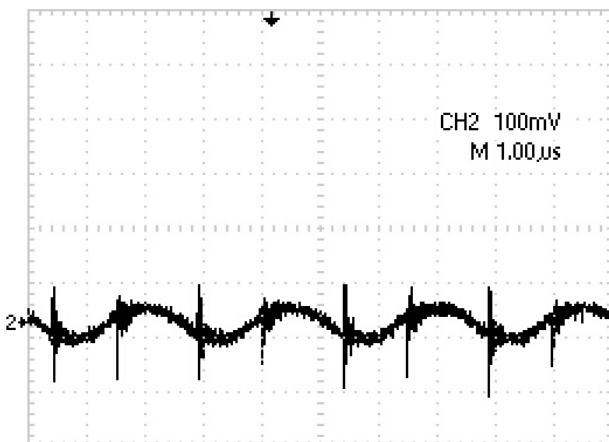

SW ( $V_{IN}=12V, V_{OUT}=3.3V, I_{LOAD}=1A$ )

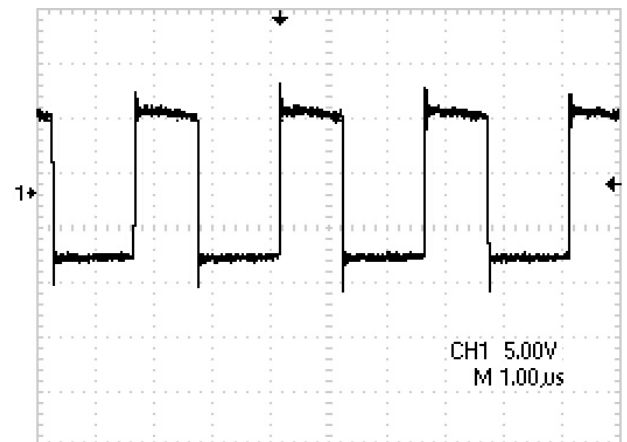

## Pin Functions

**N/C (Pin 1, 8):** No Connect.

**VIN (Pin 2):** Main Supply Pin. The HM1583A operates from a 5V to 16V unregulated input. It must be closely decoupled to GND, Pin 4, with a 20 $\mu$ F or greater ceramic capacitor to prevent large voltage spikes from appearing at the input.

**SW (Pin 3):** Switch Node Connection to Inductor. This pin connects to the drains of the internal main and synchronous power MOSFET switches.

**GND (Pin 4):** Ground Pin.

**FB (Pin 5):** Feedback Pin. Receive the feedback voltage from an external resistive divider across the output. In the adjustable version, the output voltage is fixed. The output voltage is set by R2 and R3:  
 $V_{OUT} = 0.8V \cdot [1 + (R2/R3)]$ .

**COMP (Pin 6):** This node is the output of the transconductance error amplifier and the input to the current comparator. Frequency compensation is done at this node by connecting a series R-C to ground.

**EN (Pin 7):** En Control Input. Do not leave EN floating.

---



---

## Application Information

### Inductor Selection

For most applications, the value of the inductor will fall in the range of 1μH to 4.7μH. Its value is chosen based on the desired ripple current. Large value inductors lower ripple current and small value inductors result in higher ripple currents. Higher  $V_{IN}$  or  $V_{OUT}$  also increases the ripple current as shown in equation. A reasonable starting point for setting ripple current is  $\Delta I_L = 1.2A$  (40% of 3A).

$$\Delta I_L = \frac{1}{(f)(L)} V_{OUT} \left( 1 - \frac{V_{OUT}}{V_{IN}} \right)$$

The DC current rating of the inductor should be at least equal to the maximum load current plus half the ripple current to prevent core saturation. Thus, a 3.6A rated inductor should be enough for most applications (3A + 0.6A). For better efficiency, choose a low DC-resistance inductor.

Different core materials and shapes will change the size/current and price/current relationship of an inductor. Toroid or shielded pot cores in ferrite or perm alloy materials are small and don't radiate much energy, but generally cost more than powdered iron core inductors with similar electrical characteristics. The choice of which style inductor to use often depends more on the price vs. size requirements and any radiated field/EMI requirements than on what HM1583A requires to operate.

### Efficiency Considerations

The efficiency of a switching regulator is equal to the output power divided by the input power times 100%. It is often useful to analyze individual losses to determine what is limiting the efficiency and which change would produce the most improvement. Efficiency can be expressed as: Efficiency = 100% - (L1+ L2+ L3+ ...) where L1, L2, etc. are the individual losses as a percentage of input power. Although all dissipative elements in the circuit produce losses, two main sources usually account for most of the losses:  $V_{IN}$  quiescent current and  $I^2R$  losses. The  $V_{IN}$  quiescent current loss dominates the efficiency loss at very low load currents whereas the  $I^2R$  loss dominates the efficiency loss at medium to high load currents. In a typical efficiency plot, the efficiency curve at very low load currents can be misleading since the actual power lost is of no consequence.

1. The  $V_{IN}$  quiescent current is due to two components: the DC bias current as given in the electrical characteristics and the internal main switch and synchronous switch gate charge currents. The gate charge current results from switching the gate capacitance of the internal power MOSFET switches. Each time the gate is switched from high to low to high again, a packet of charge  $\Delta Q$  moves from  $V_{IN}$  to ground. The resulting  $\Delta Q/\Delta t$  is the current out of  $V_{IN}$  that is typically larger than the DC bias current. In continuous mode,  $I_{GATECHG} = f(Q_T + Q_B)$  where  $Q_T$  and  $Q_B$  are the gate charges of the internal top and bottom switches. Both the DC bias and gate charge losses are proportional to  $V_{IN}$  and thus their effects will be more pronounced at higher supply voltages.

2.  $I^2R$  losses are calculated from the resistances of the internal switches,  $R_{SW}$  and external inductor  $R_L$ . In continuous mode the average output current flowing through inductor L is "chopped" between the main switch and the synchronous switch. Thus, the series resistance looking into the SW pin is a function of both top and bottom MOSFET  $R_{DS(ON)}$  and the duty cycle (DC) as follows:  $R_{SW} = R_{DS(ON)TOP} \times DC + R_{DS(ON)BOT} \times (1-DC)$  The  $R_{DS(ON)}$  for both the top and bottom MOSFETs can be obtained from the

---

Typical Performance Characteristics curves. Thus, to obtain  $I^2R$  losses, simply add  $R_{SW}$  to  $R_L$  and multiply the result by the square of the average output current. Other losses including  $C_{IN}$  and  $C_{OUT}$  ESR dissipative losses and inductor core losses generally account for less than 2% of the total loss.

### **Board Layout Suggestions**

When laying out the printed circuit board, the following checklist should be used to ensure proper operation of the HM1583A. Check the following in your layout:

1. The power traces, consisting of the GND trace, the SW trace and the VIN trace should be kept short, direct and wide.
  2. Put the input capacitor as close as possible to the device pins (VIN and GND).
  3. SW node is with high frequency voltage swing and should be kept small area. Keep analog components away from SW node to prevent stray capacitive noise pick-up.
  4. Connect all analog grounds to a command node and then connect the command node to the power ground behind the output capacitors.
-

## Packaging Information

### SOP-8L Package Outline Dimension

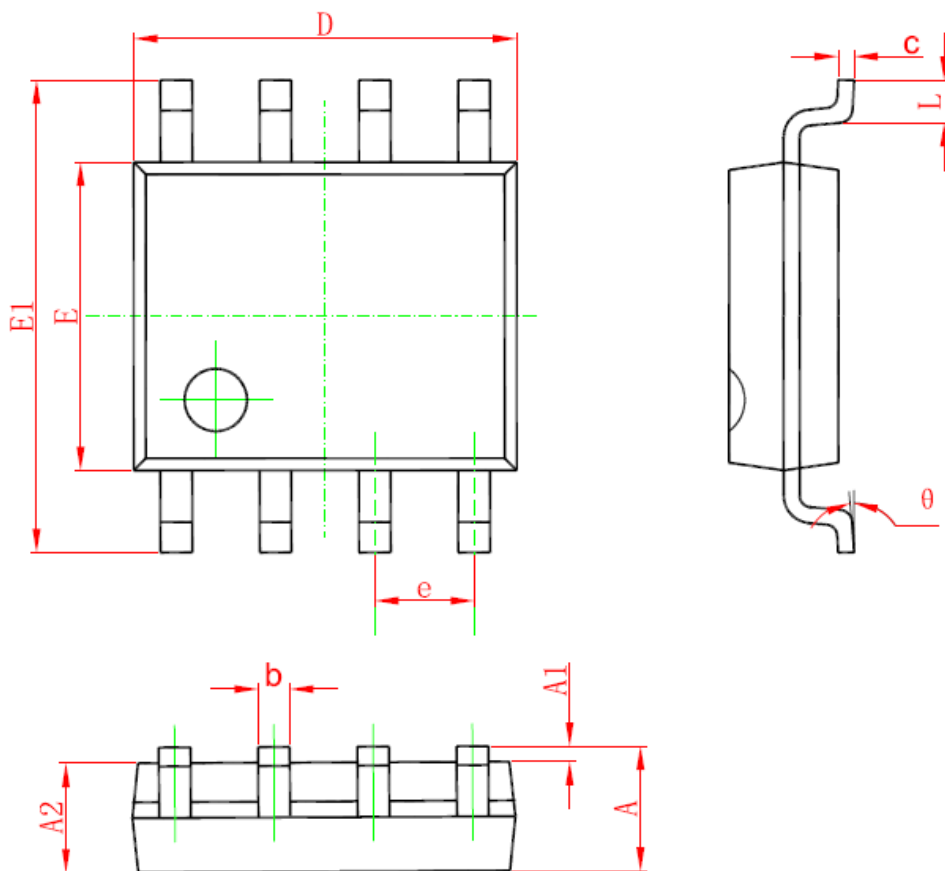

Symbol	Dimensions In Millimeters		Dimensions In Inches	
	Min	Max	Min	Max
A	1.350	1.750	0.053	0.069
A1	0.100	0.250	0.004	0.010
A2	1.350	1.550	0.053	0.061
b	0.330	0.510	0.013	0.020
c	0.170	0.250	0.006	0.010
D	4.700	5.100	0.185	0.200
E	3.800	4.000	0.150	0.157
E1	5.800	6.200	0.228	0.244
e	1.270(BSC)		0.050(BSC)	
L	0.400	1.270	0.016	0.050
θ	0°	8°	0°	8°