

<A (\$) \$8 F 1mA~200mA Linear Li-Ion Battery Charger

GENERAL DESCRIPTION

The HM4050DR is a complete constant current & constant voltage linear charger for single cell lithium-ion batteries. Its DFN2x3 package and low external component count make the HM4050DR ideally suited for portable applications.

Furthermore, the HM4050DR is specifically designed to work within USB power specifications.

No external sense resistor is needed, and no blocking diode is required due to the internal MOSFET architecture. Thermal feedback regulates the charge current to limit the die temperature during high power operation or high ambient temperature. The charge voltage is fixed at 4.2V, and the charge current can be programmed externally with a single resistor. The HM4050DR automatically terminates the charge cycle when the charge current drops to 1/10th the programmed value after the final float voltage is reached.

When the input supply (wall adapter or USB supply) is removed, the HM4050DR automatically enters a low current state, dropping the battery drain current to less than 2uA. The HM4050DR can be put into shutdown mode, reducing the supply current to 50uA.

Other features include Battery temperature monitor, under-voltage lockout, automatic recharge and two status pins to indicate charge and charge termination.

FEATURES

Programmable Charge Current Up to 200mA
 No MOSFET, Sense Resistor or Blocking Diode Required

Complete Linear Charger in DFN2x3 Package for single Cell Lithium-Ion Batteries

Constant-Current/Constant-Voltage Operation with Thermal Regulation to Maximize Charge Rate Without Risk of Overheating

Charges Single Cell Li-Ion Batteries Directly from USB Port

Preset 4.2V Charge Voltage with $\pm 1\%$ Accuracy
 Charge Current Monitor Output for Gas Gauging
 Automatic Recharge

Charge state pairs of output, no battery and fault status display

C/10 Charge Termination

50uA Supply Current in Shutdown

2.9V Trickle Charge Threshold

Soft-Start Limits Inrush Current

Battery temperature monitoring function

ESD HBM 8KV

Available in DFN2x3-8 Package

APPLICATIONS

Wearable device

Small capacity battery charger application

Bluetooth 、 GPS Applications

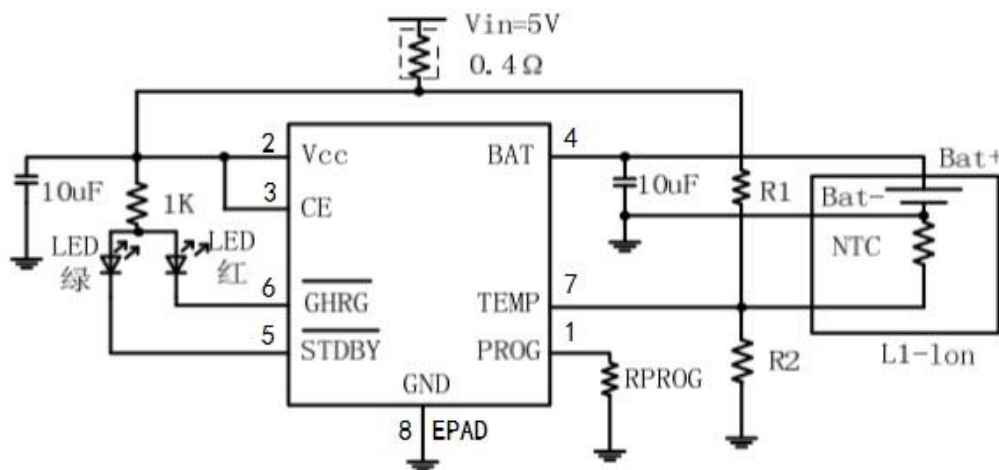

Figure1 . Typical Application Circuit

ORDERING INFORMATION

PART NUMBER	TEMP RANGE	VIN	VBAT	CHARGE CURRENT	PACKAGE	PINS
HM4050DR	-40°C to 85°C	4.5~6V	4.2V	1mA~200mA	DFN2x3	8

PIN CONFIGURATION

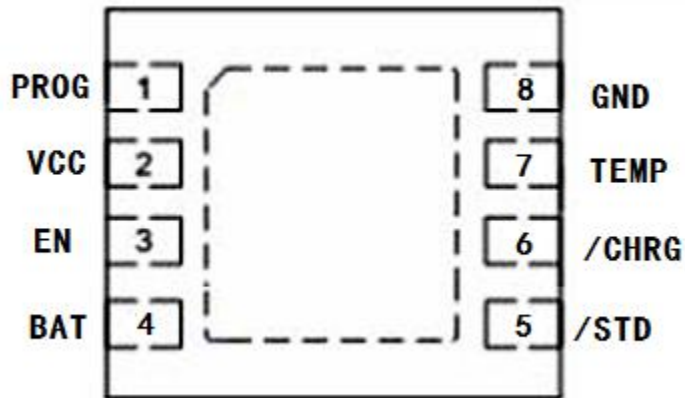

Figure 2. PIN Configuration

PIN DESCRIPTION

PIN NUMBER	PIN NAME	PIN DESCRIPTION
1	PROG	Charge Current Program, Charge Current Monitor and Shutdown Pin.
2	VCC	Positive Input Supply Voltage.
3	EN	Chip enable input.
4	BAT	Charge Current Output.
5	/STBY	The completion of battery charging instructions side.
6	/CHRG	Open-Drain Charge Status Output.
7,	TEMP	Battery temperature detection input, do not let this pin float.
8,9	GND	Ground

ABSOLUTE MAXIMUM RATINGS

(Note: Do not exceed these limits to prevent damage to the device. Exposure to absolute maximum rating conditions for long periods may affect device reliability.)

PARAMETER	VALUE	UNIT
Input Supply Voltage VCC	VSS-0.3 ~ VSS+7	V
PROG pin Voltage Vprog	VSS-0.3 ~ Vcc+0.3	V
BAT pin Voltage Vbat	Vss-0.3 ~ 7	V
CHAG pin Voltage Vchrg	VSS-0.3 ~ VSS+7	V
BAT pin Current Ibat	0.25	A
PROG pin Current Iprog	2.5	mA
Operating Ambient Temperature	-40 to 85	°C
Maximum Junction Temperature	150	°C
Storage Temperature	-55 to 150	°C
Lead Temperature (Soldering, 10 sec)	260	°C

ELECTRICAL CHARACTERISTICS

(VIN = 3.6V, TA = 25°C unless otherwise specified)

PARAMETER	SYMBOL	TEST CONDITIONS	MIN	TYP	MAX	UNIT
Input Voltage Range	VCC		4.25		6.5	V
Input supply current	Icc	Charge mode, RPROG =1K		350	2000	uA
		Standby mode		150	500	uA
		Shutdown mode(RPROG not connected, Vcc<Vbat or Vcc<Vuv)		50	100	uA
BAT pin Current	Ibat	RPROG =1k, Current mode	79	88	97	mA
		RPROG =2k, Current mode	40	44	50	mA
		RPROG =10k, Current mode	7	8	9	mA
		Standby mode, Vbat=4.2V	0	-2.5	-6	uA
		Shutdown mode		1	2.5	uA
		Sleep mode, Vcc=0V		0.3	2.5	uA
Regulated Charge Voltage	Vfloat	0°C ≤ TA ≤ 85°C, Icharge = 4mA	4.158	4.2	4.242	V
PROG pin Voltage	Vprog	RPROG =10k, Current mode	0.92	1.0	1.08	V
Trickle charge current	Itrikl	Vbat < Vtrikl, Rprog=2k	3	4	5	mA
Trickle charge Threshold Voltage	Vtrikl	RPROG =10K, Vbat Rising	2.8	2.9	3.0	V

Trickle voltage hysteresis voltage	Vtrhys	$R_{PROG} = 10K$	60	80	110	mV
Recharge Battery threshold Voltage	ΔV_{recg}	$V_{FLOAT} - V_{RECHRG}$		150	300	mV
CHRG pin Output low voltage	Vchrg	Ichrg=5mA		0.35	0.6	V
STDBY pin Output low voltage	Vstdby	Istdby=5mA		0.35	0.6	V
Enable Threshold		$VCC = 4.25V \sim 6.5V$	0.3	1	1.5	V
Enable Leakage Current			-0.1		+0.1	uA
TEMP pin voltage of the high-end flip	Vtemp-h			80	82	%V _c
TEMP pin voltage of the low-end flip	Vtemp-l		43	45		%V _c

PIN FUNCTION

PROG (PIN 1): Charge Current Program, Charge Current Monitor and Shutdown Pin.

The charge current is programmed by connecting a 1% resistor, RPROG, to ground. When charging in constant-current mode, this pin serves to 1V. In all modes, the voltage on this pin can be used to measure the charge current using the following formula:

$$IBAT = (VPROG/RPROG) \times 88.$$

The PROG pin can also be used to shut down the charger. Disconnecting the program resistor from ground allows a 0.05uA current to pull the PROG pin high. When it reaches the 1.21V shutdown threshold voltage, the charger enters shutdown mode, charging stops and the input supply current drops to 50uA. This pin is also clamped to approximately 2.4V. Driving this pin to voltages beyond the clamp voltage will draw currents as high as 1.5mA. Reconnecting RPROG to ground will return the charger to normal operation.

VCC (PIN 2): Positive Input Supply Voltage.

Provides power to the charger, VCC can range from 4.25V to 6.5V and should be bypassed with at least a 10uF capacitor. When VCC drops to within 30mV of the BAT pin voltage, the HM4050DR enters shutdown mode, dropping IBAT to less than 2uA.

CE OR EN (PIN 3): Chip enable input.

High input level will make HM4050DR in normal working condition; low input level so that HM4050DR is prohibited charging status. CE pin can be TTL or CMOS level-level driver.

BAT (PIN 4): Charge Current Output.

Provides charge current to the battery and regulates the final float voltage to 4.2V. An internal precision resistor divider from this pin sets the float voltage which is disconnected in shutdown mode.

STDBY (PIN 5): The completion of battery charging instructions side.

When the battery charge is complete, STDBY pulled low by internal switches, indicating the completion of charging. In addition, STDBY pin will be in a high-impedance state.

CHRG (PIN 6): Open-Drain Charge Status Output.

When the battery is charging, the CHRG pin is pulled low by an internal N-channel MOSFET. When the charge cycle is completed, CHRG pin will be in a high-impedance state.

TEMP (PIN 7): Battery temperature detection input.

TEMP pin to receive the battery NTC sensor output.

If the TEMP pin voltage is less than the input voltage is greater than 45% or 80% of the input voltage means the battery temperature is too low or too high, then the charge has been suspended.

If the TEMP direct access GND, battery temperature detection canceled, the other charged and functioning properly.

Please do not let this pin float.

GND & EPAD (PIN 8): Ground. Please connect with mass metal

TYPICAL PERFORMANCE CHARACTERISTICS

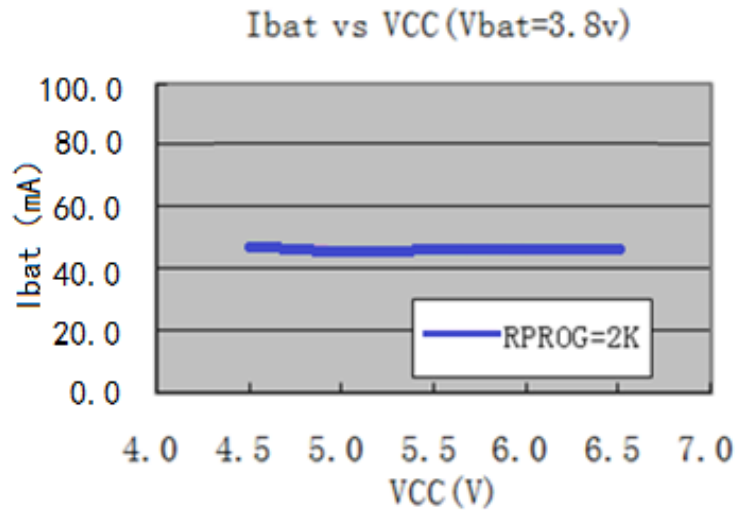
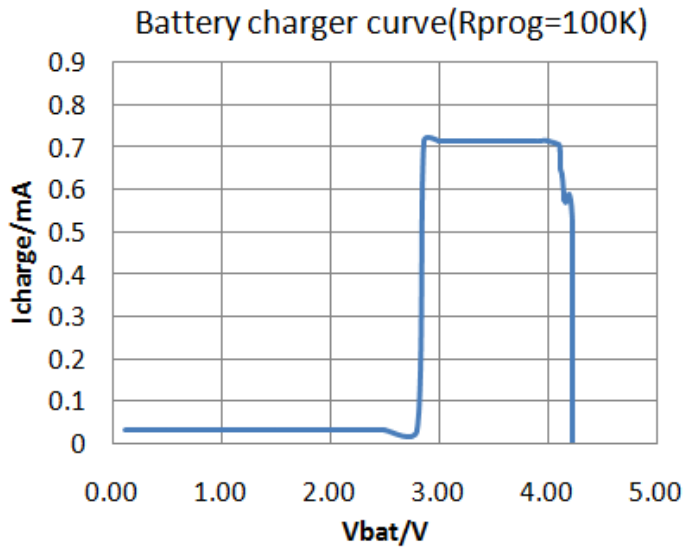
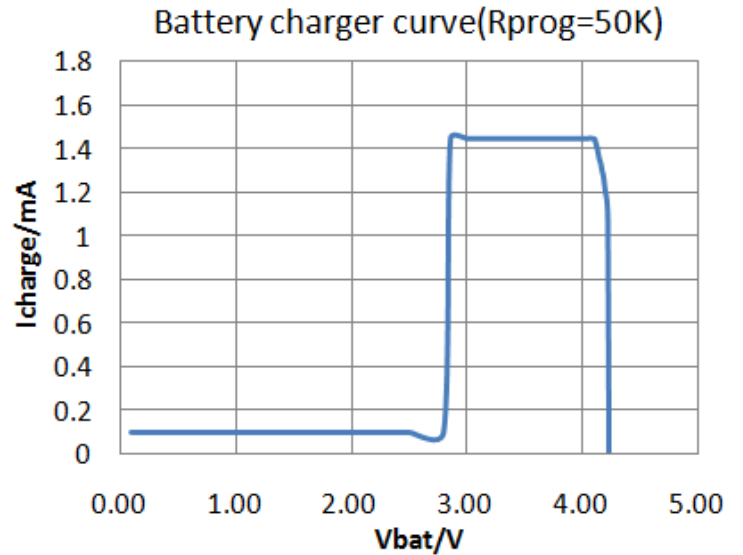
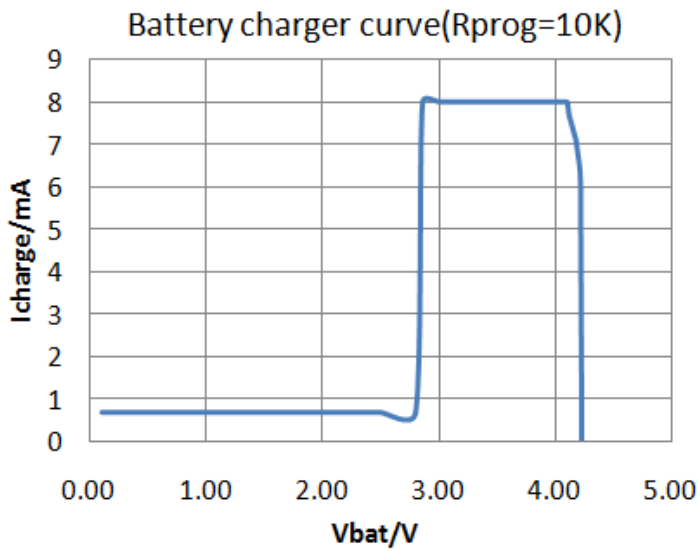
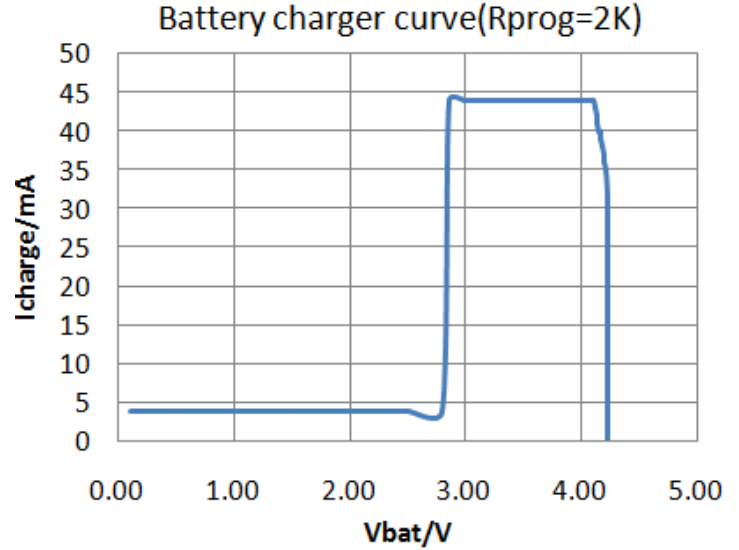
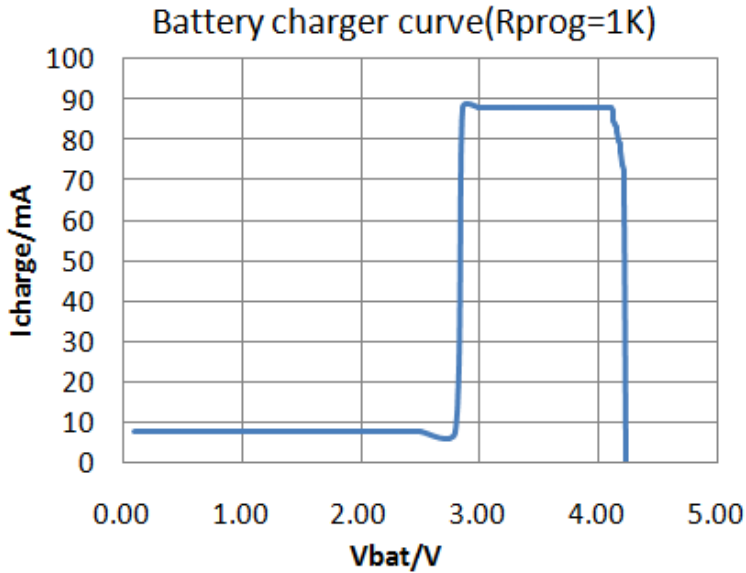

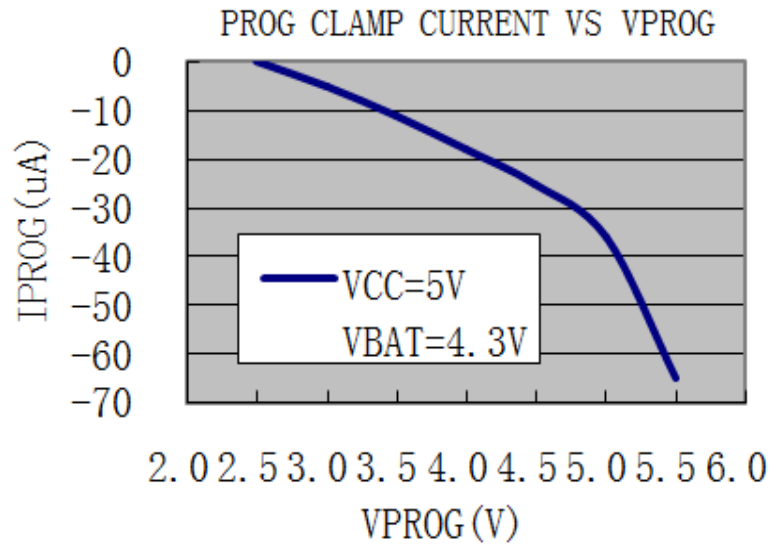
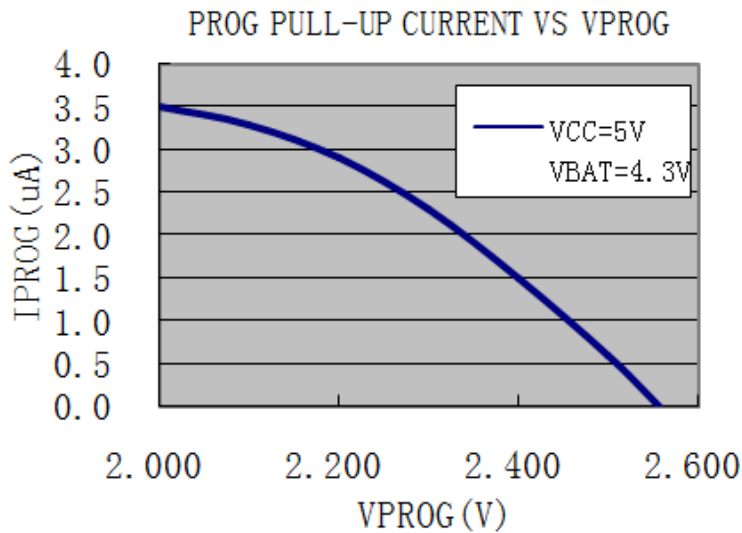
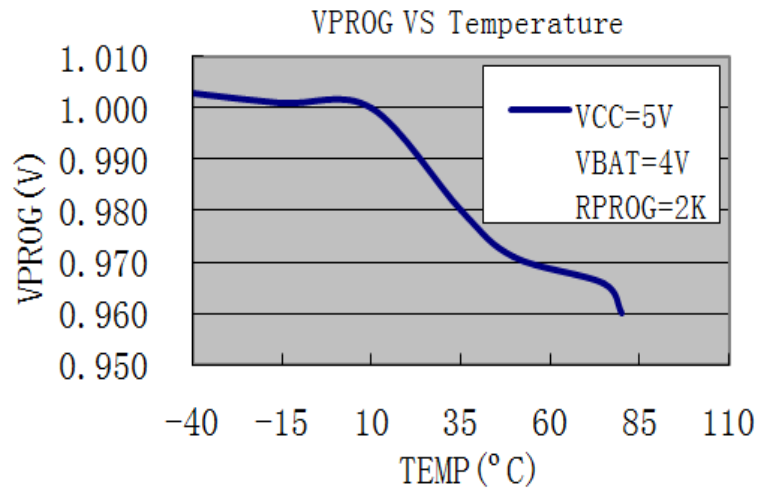
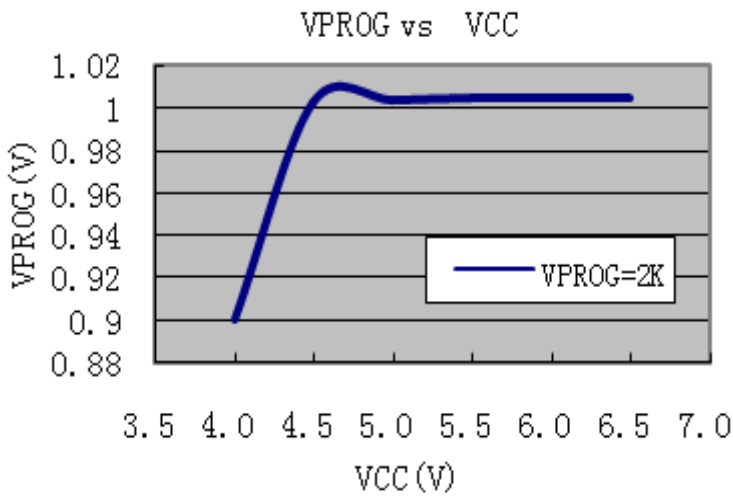

PACKAGE OUTLINE

DFN2X3-8 PACKAGE OUTLINE AND DIMENSIONS

