

HM4N60

主要参数 MAIN CHARACTERISTICS

I_D	4.0 A
V_{DSS}	600 V
$R_{dson}(@V_{gs}=10V)$	2.4 Ω
Q_g	13.3nC

用途

- 高频开关电源
- 电子镇流器
- UPS 电源

产品特性

- 低栅极电荷
- 低 C_{rss} (典型值 9pF)
- 开关速度快
- 产品全部经过雪崩测试
- 高抗 dv/dt 能力
- RoHS 产品

APPLICATIONS

- High efficiency switch mode power supplies
- Electronic lamp ballasts based on half bridge
- UPS

FEATURES

- Low gate charge
- Low C_{rss} (typical 9pF)
- Fast switching
- 100% avalanche tested
- Improved dv/dt capability
- RoHS product

封装 Package

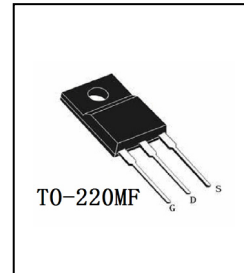
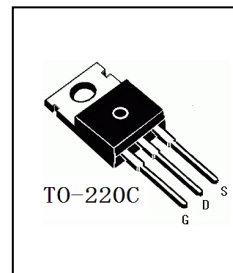
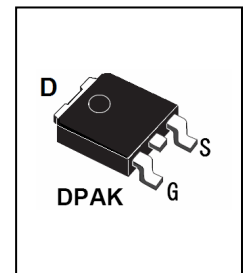
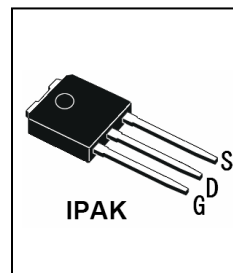
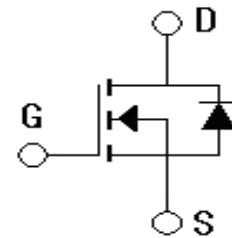

订货信息 ORDER MESSAGE

订货型号 Order codes	印记 Marking	封装 Package	无卤素 Halogen Free	包装 Packaging	器件重量 Device Weight
HM4N60I	HM4N60I	IPAK	NO	Tube	0.35 g(typ)
HM4N60K	HM4N60K	DPAK	NO	Tube	0.30 g(typ)
HM4N60	HM4N60	TO-220C	NO	Tube	2.15 g(typ)
HM4N60F	HM4N60F	TO-220MF	NO	Tube	2.20 g(typ)

绝对最大额定值 ABSOLUTE RATINGS (Tc=25℃)

项 目 Parameter	符 号 Symbol	数 值 Value			单 位 Unit
		HM4N60I/K	HM4N60	HM4N60F	
最高漏极-源极直流电压 Drain-Source Voltage	V _{DSS}	600			V
连续漏极电流 Drain Current -continuous	I _D T=25℃ T=100℃	4.0		4.0*	A
		2.5		2.5*	A
最大脉冲漏极电流 (注1) Drain Current - pulse (note 1)	I _{DM}	16		16*	A
最高栅源电压 Gate-Source Voltage	V _{GSS}	±30			V
单脉冲雪崩能量 (注2) Single Pulsed Avalanche Energy note 2)	E _{AS}	240			mJ
雪崩电流 (注1) Avalanche Current (note 1)	I _{AR}	4.0			A
重复雪崩能量 (注1) Repetitive Avalanche Current (note 1)	E _{AR}	10.0			mJ
二极管反向恢复最大电压变化 速率 (注3) Peak Diode Recovery dv/dt (note 3)	dv/dt	5.5			V/ns
耗散功率 Power Dissipation	P _D T _C =25℃ -Derate above 25℃	51	100	33	W
		0.39	0.80	0.26	W/℃
最高结温及存储温度 Operating and Storage Temperature Range	T _J , T _{STG}	-55~+150			℃
引线最高焊接温度 Maximum Lead Temperature for Soldering Purposes	T _L	300			℃

*漏极电流由最高结温限制

*Drain current limited by maximum junction temperature

电特性 ELECTRICAL CHARACTERISTICS

项 目 Parameter	符 号 Symbol	测试条件 Tests conditions	最小 Min	典型 Typ	最大 Max	单 位 Units
关态特性 Off –Characteristics						
漏—源击穿电压 Drain-Source Voltage	BV_{DSS}	$I_D=250\mu A, V_{GS}=0V$	600	-	-	V
击穿电压温度特性 Breakdown Voltage Temperature Coefficient	$\Delta BV_{DSS}/\Delta T_J$	$I_D=250\mu A$, referenced to $25^\circ C$	-	0.65	-	V/ $^\circ C$
零栅压下漏极漏电流 Zero Gate Voltage Drain Current	I_{DSS}	$V_{DS}=600V, V_{GS}=0V,$ $T_C=25^\circ C$	-	-	10	μA
		$V_{DS}=480V, T_C=125^\circ C$	-	-	100	μA
正向栅极体漏电流 Gate-body leakage current, forward	I_{GSSF}	$V_{DS}=0V, V_{GS}=30V$	-	-	100	nA
反向栅极体漏电流 Gate-body leakage current, reverse	I_{GSSR}	$V_{DS}=0V, V_{GS}=-30V$	-	-	-100	nA
通态特性 On-Characteristics						
阈值电压 Gate Threshold Voltage	$V_{GS(th)}$	$V_{DS} = V_{GS}, I_D=250\mu A$	2.0	-	4.0	V
静态导通电阻 Static Drain-Source On-Resistance	$R_{DS(ON)}$	$V_{GS} = 10V, I_D=2A$	-	1.7	2.4	Ω
正向跨导 Forward Transconductance	g_{fs}	$V_{DS} = 40V, I_D=2A$ (note 4)	-	4.7	-	S
动态特性 Dynamic Characteristics						
输入电容 Input capacitance	C_{iss}	$V_{DS}=25V,$ $V_{GS}=0V,$ $f=1.0MHz$	-	490	642	pF
输出电容 Output capacitance	C_{oss}		-	95	124	pF
反向传输电容 Reverse transfer capacitance	C_{riss}		-	9	12	pF

电特性 ELECTRICAL CHARACTERISTICS

开关特性 Switching Characteristics					
延迟时间 Turn-On delay time	$t_{d(on)}$	$V_{DD}=300V, I_D=4A, R_G=25\Omega$ (note 4, 5)	-	16	42 ns
上升时间 Turn-On rise time	t_r		-	49	111 ns
延迟时间 Turn-Off delay time	$t_{d(off)}$		-	46	102 ns
下降时间 Turn-Off Fall time	t_f		-	37	84 ns
栅极电荷总量 Total Gate Charge	Q_g	$V_{DS}=480V,$ $I_D=4A$ $V_{GS}=10V$ (note 4, 5)	-	13.3	19 nC
栅-源电荷 Gate-Source charge	Q_{gs}		-	3.6	- nC
栅-漏电荷 Gate-Drain charge	Q_{gd}		-	4.9	- nC
漏-源二极管特性及最大额定值 Drain-Source Diode Characteristics and Maximum Ratings					
正向最大连续电流 Maximum Continuous Drain-Source Diode Forward Current		I_S	-	-	4 A
正向最大脉冲电流 Maximum Pulsed Drain-Source Diode Forward Current		I_{SM}	-	-	16 A
正向压降 Drain-Source Diode Forward Voltage	V_{SD}	$V_{GS}=0V,$ $I_S=4.0A$	-	-	1.4 V
反向恢复时间 Reverse recovery time	t_{rr}	$V_{GS}=0V, I_S=4.0A$ $di_F/dt=100A/\mu s$ (note 4)	-	330	- ns
反向恢复电荷 Reverse recovery charge	Q_{rr}		-	2.67	- μC

热特性 THERMAL CHARACTERISTIC

项 目 Parameter	符 号 Symbol	最大 Max			单位 Unit
		HM4N60 I/K	HM4N60	HM4N60F	
结到管壳的热阻 Thermal Resistance, Junction to Case	$R_{th(j-c)}$	2.50	1.25	3.79	$^{\circ}C/W$
结到环境的热阻 Thermal Resistance, Junction to Ambient	$R_{th(j-A)}$	83	62.5	62.5	$^{\circ}C/W$

注释:

- 1: 脉冲宽度由最高结温限制
- 2: $L=25mH, I_{AS}=4.0A, V_{DD}=50V, R_G=25\Omega$, 起始结温 $T_J=25^{\circ}C$
- 3: $I_{SD} \leq 4.0A, di/dt \leq 200A/\mu s, V_{DD} \leq BV_{DSS}$, 起始结温 $T_J=25^{\circ}C$
- 4: 脉冲测试: 脉冲宽度 $\leq 300\mu s$, 占空比 $\leq 2\%$
- 5: 基本与工作温度无关

Notes:

- 1: Pulse width limited by maximum junction temperature
- 2: $L=25mH, I_{AS}=4.0A, V_{DD}=50V, R_G=25\Omega$, Starting $T_J=25^{\circ}C$
- 3: $I_{SD} \leq 4.0A, di/dt \leq 200A/\mu s, V_{DD} \leq BV_{DSS}$, Starting $T_J=25^{\circ}C$
- 4: Pulse Test: Pulse Width $\leq 300\mu s$, Duty Cycle $\leq 2\%$
- 5: Essentially independent of operating temperature

特征曲线 ELECTRICAL CHARACTERISTICS (curves)

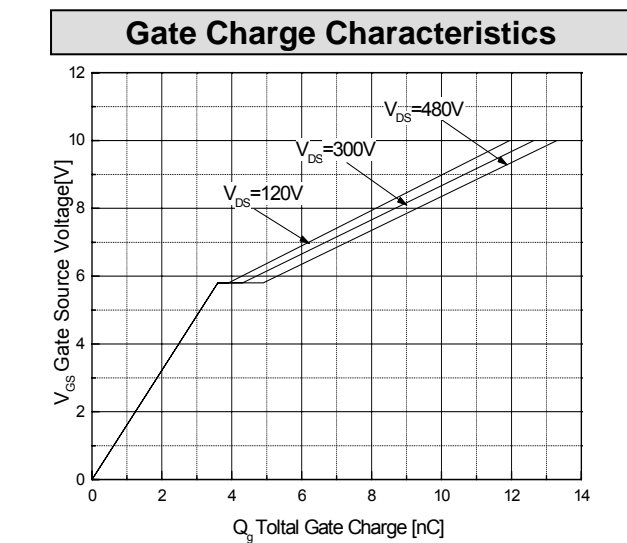
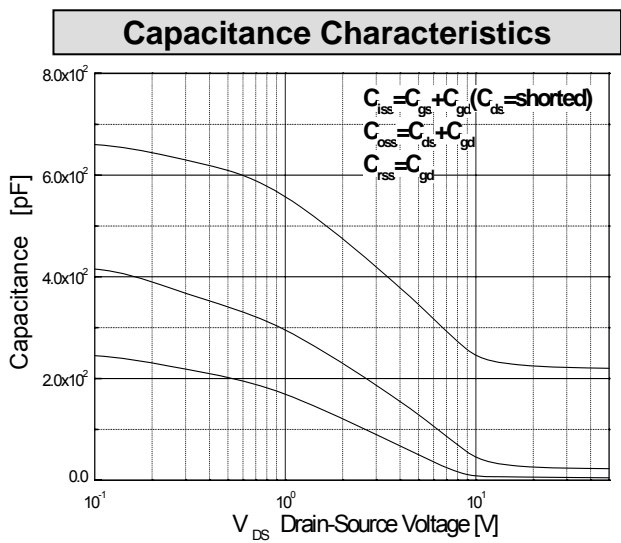
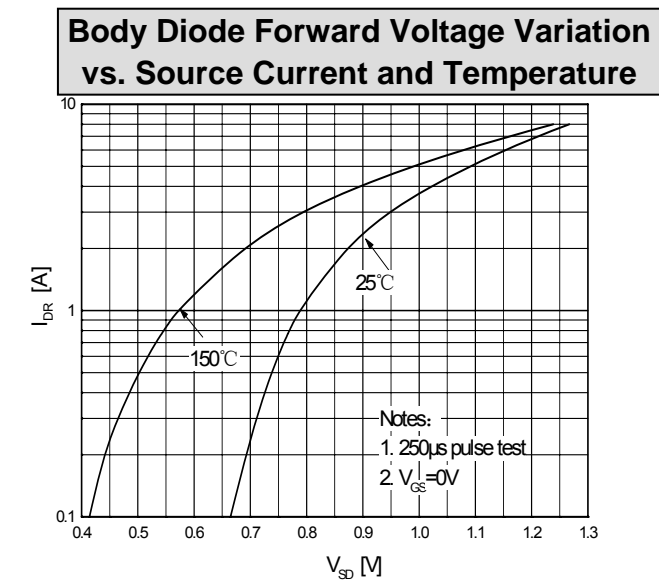
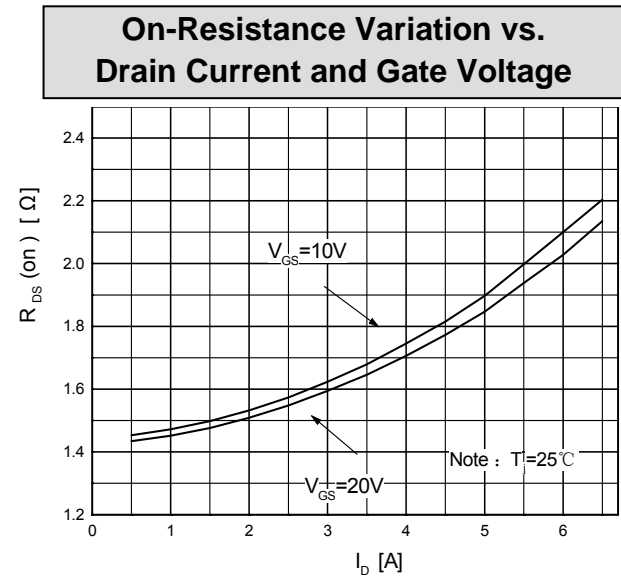
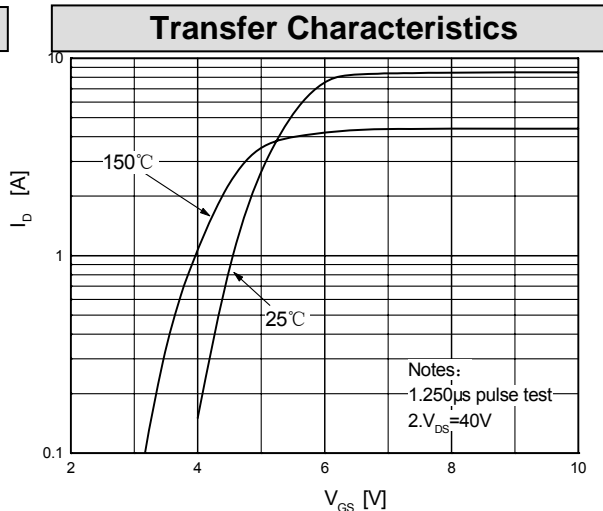
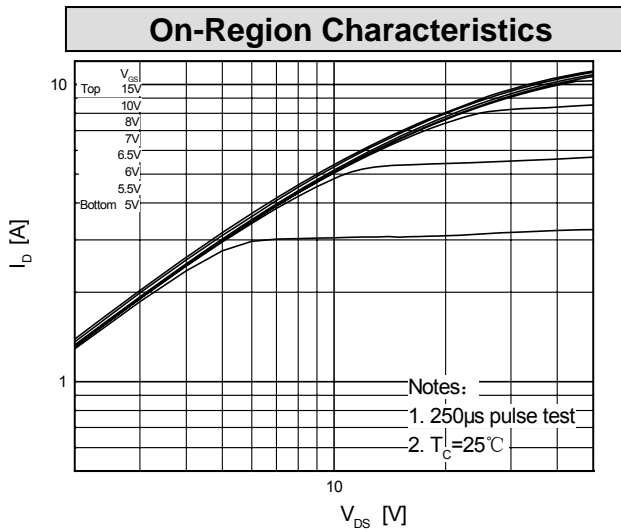

特征曲线 ELECTRICAL CHARACTERISTICS (curves)

Breakdown Voltage Variation vs. Temperature

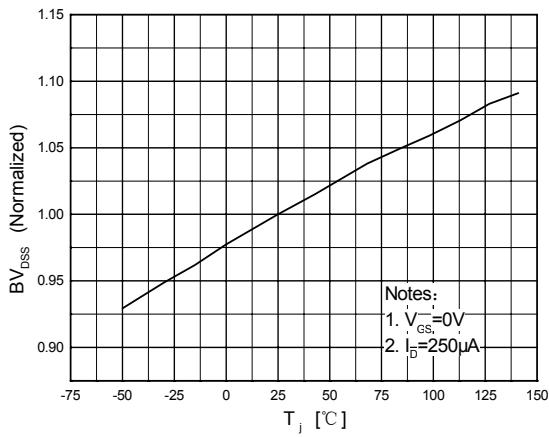

On-Resistance Variation vs. Temperature

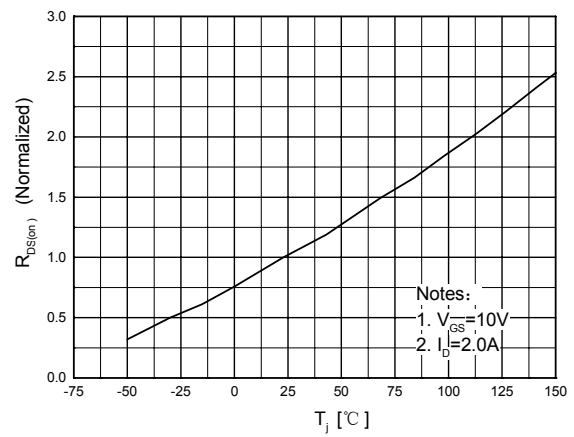

Maximum Safe Operating Area For HM4N60/I/K

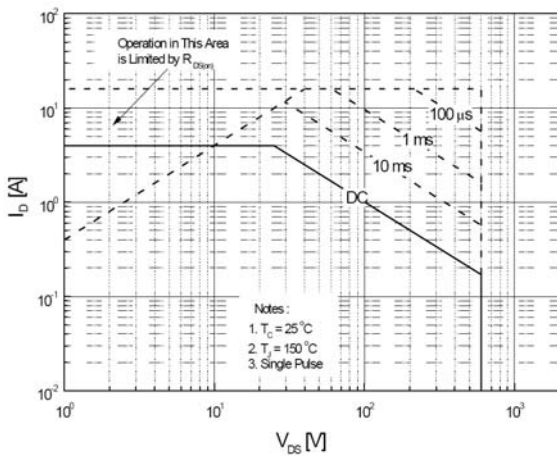

Maximum Safe Operating Area For HM4N60F

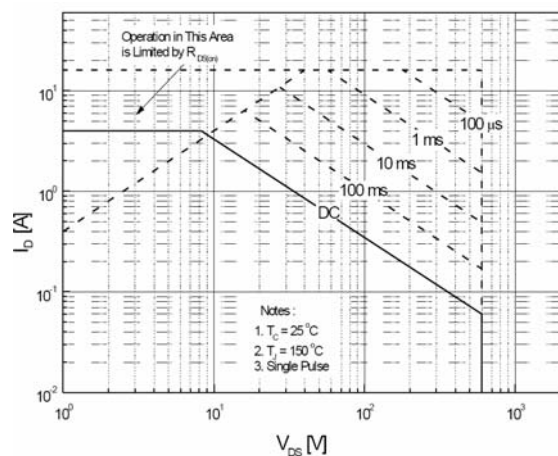

Maximum Drain Current vs. Case Temperature

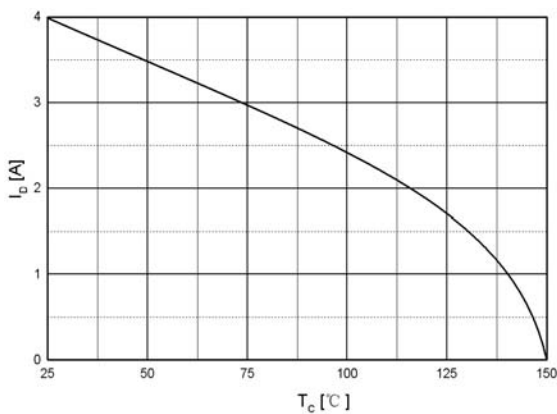

特征曲线 ELECTRICAL CHARACTERISTICS (curves)

Transient Thermal Response Curve
For HM4N60/I/K

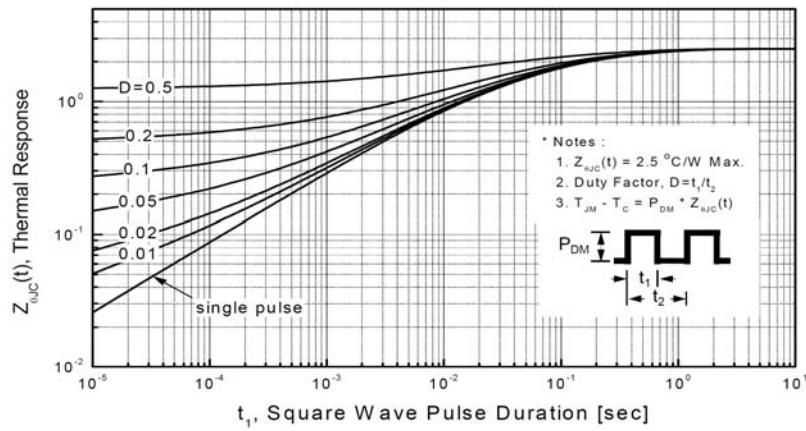

Transient Thermal Response Curve
For HM4N60

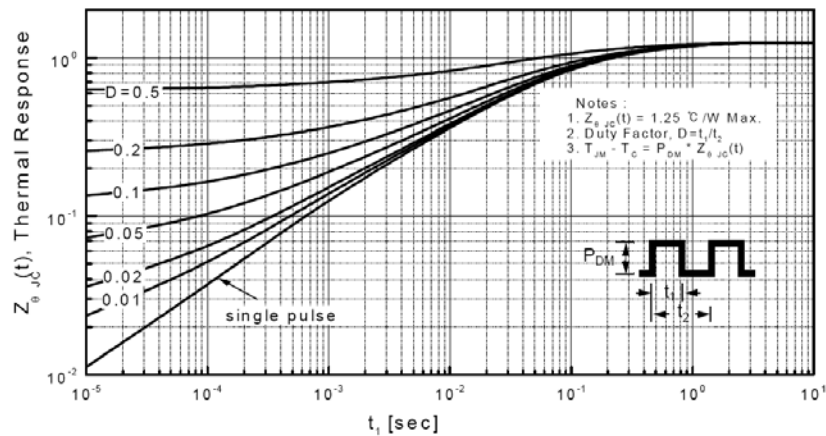

Transient Thermal Response Curve
For HM4N60F

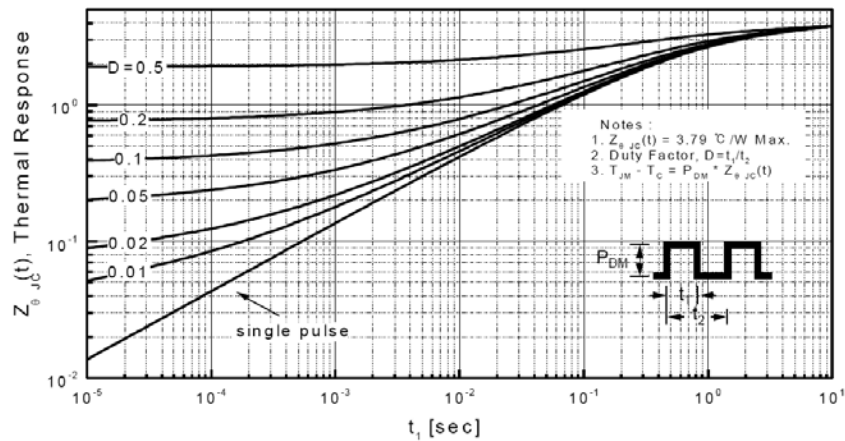

外形尺寸 PACKAGE MECHANICAL DATA

IPAK

单位 Unit: mm

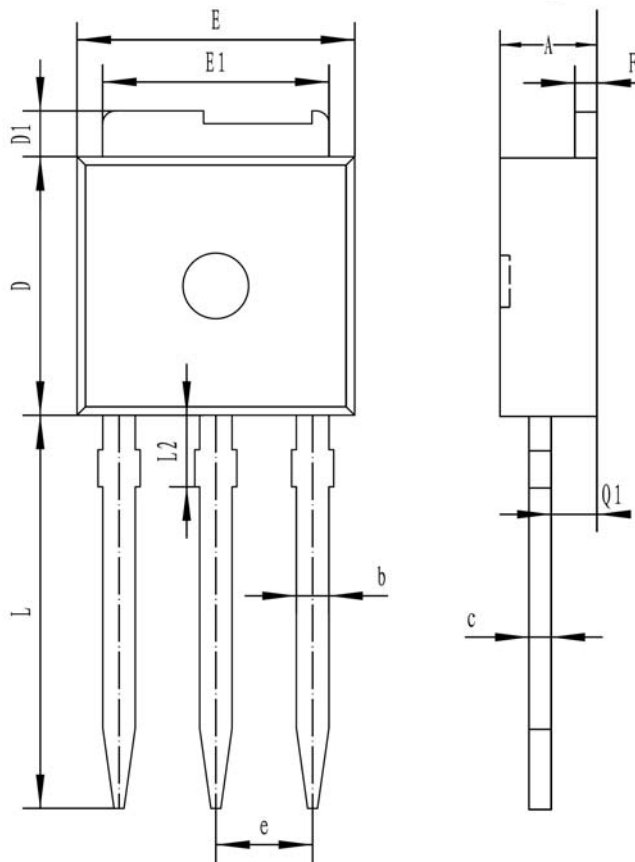

符号 symbol	MIN	MAX
A	2.19	2.38
b	0.64	0.89
c	0.46	0.58
D	5.97	6.22
D1	0.89	1.27
E	6.35	6.73
E1	5.21	5.46
e	2.28TYP	
F	0.46	0.58
L	8.89	9.65
L2	2.25	2.35
Q1	1.02	1.14

外形尺寸 PACKAGE MECHANICAL DATA

DPAK

单位 Unit: mm

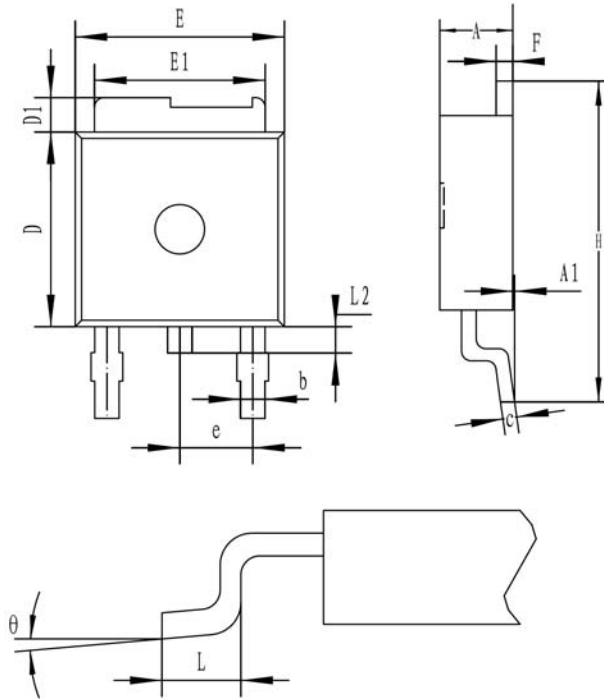

符号 symbol	MIN	MAX
A	2.19	2.38
A1		0.13
b	0.64	0.89
c	0.46	0.61
D	5.97	6.22
D1	0.89	1.27
E	6.35	6.73
E1	5.21	5.46
e	2.28TYP	
F	0.46	0.61
H	9.65	10.41
L	1.40	1.78
L2	0.64	1.01
θ	0°	8°

外形尺寸 PACKAGE MECHANICAL DATA

TO-220C

单位 Unit: mm

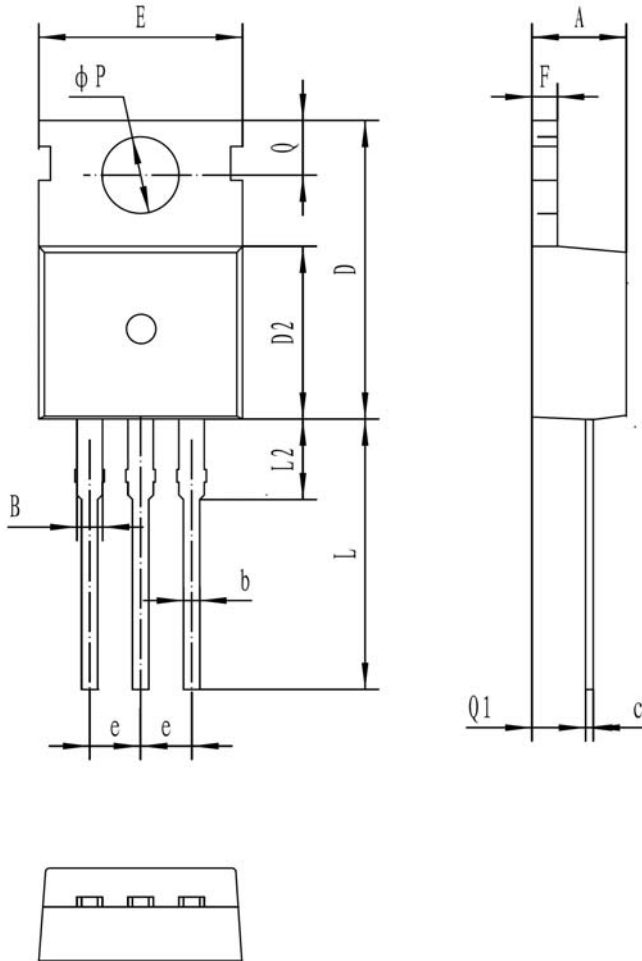

符号 symbol	MIN	MAX
A	4.30	4.70
B	1.10	1.40
b	0.70	0.95
c	0.40	0.65
D	15.20	16.20
D2	9.00	9.40
E	9.70	10.10
e	2.39	2.69
F	1.25	1.40
L	12.60	13.60
L2	2.80	3.20
Q	2.60	3.00
Q1	2.20	2.60
P	3.50	3.80

外形尺寸 PACKAGE MECHANICAL DATA

TO-220MF

单位 Unit: mm

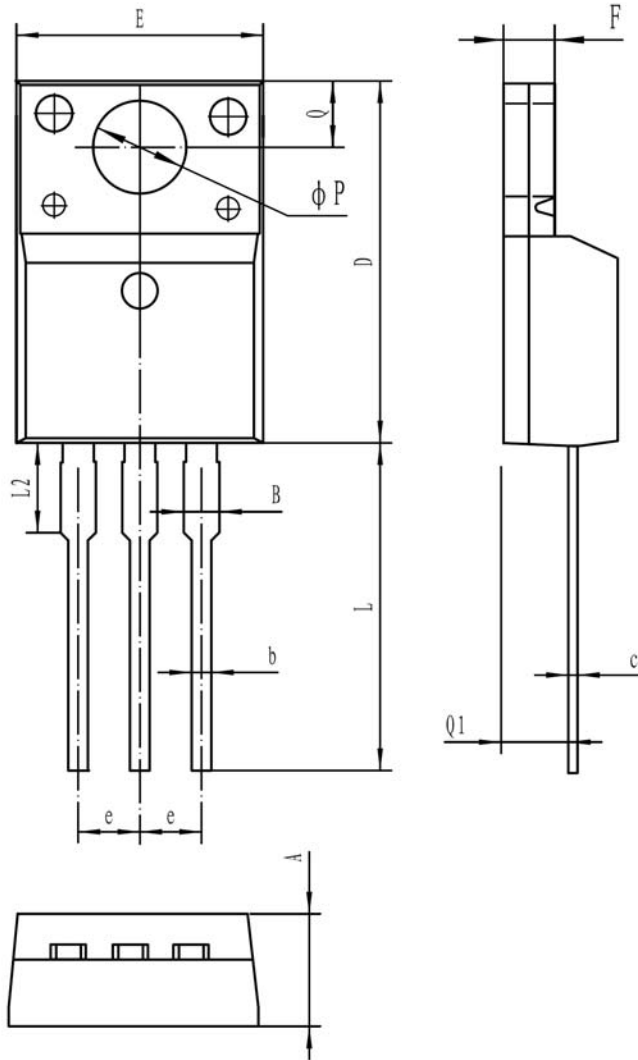

符号 Symbol	MIN	MAX
A	4.5	4.9
B	-	1.47
b	0.7	0.9
c	0.45	0.6
D	15.67	16.07
E	9.96	10.36
e	2.54TYPE	
F	2.34	2.74
L	12.58	13.38
L2	3.13	3.33
ϕP	3.08	3.28
Q	3.2	3.4
Q1	2.56	2.96