

N-Channel Enhancement Mode Power MOSFET

DESCRIPTION

The HM3307D uses advanced trench technology and design to provide excellent $R_{DS(ON)}$ with low gate charge. It can be used in a wide variety of applications.

GENERAL FEATURES

- $V_{DS} = 80V, I_D = 105A$
 $R_{DS(ON)} < 8m\Omega @ V_{GS}=10V$ (Typ:6.3m Ω)
- High density cell design for ultra low R_{dson}
- Fully characterized Avalanche voltage and current
- Good stability and uniformity with high E_{AS}
- Excellent package for good heat dissipation
- Special process technology for high ESD capability

Application

- Power switching application
- Hard Switched and High Frequency Circuits
- Uninterruptible Power Supply

100% UIS TESTED!

100% ΔV_{ds} TESTED!

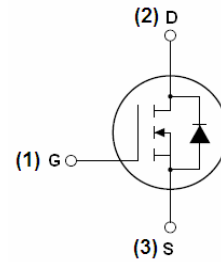

Schematic diagram

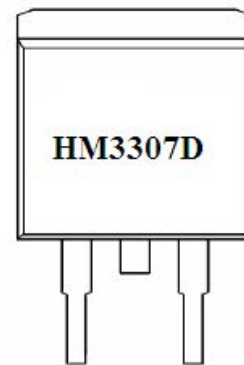

Marking and pin Assignment

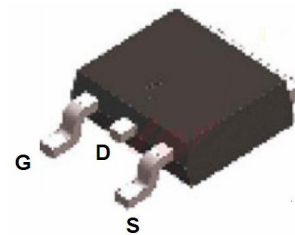

TO-263-2L top view

Package Marking And Ordering Information

Device Marking	Device	Device Package	Reel Size	Tape width	Quantity
HM3307D	HM3307D	TO-263-2L	-	-	-

Absolute Maximum Ratings (TA=25°C unless otherwise noted)

Parameter	Symbol	Limit	Unit
Drain-Source Voltage	V_{DS}	80	V
Gate-Source Voltage	V_{GS}	± 20	V
Drain Current-Continuous	I_D	105	A
Drain Current-Continuous($T_C=100^\circ C$)	$I_D(100^\circ C)$	80	A
Pulsed Drain Current	I_{DM}	420	A
Maximum Power Dissipation	P_D	200	W
Derating factor		1.33	W/ $^\circ C$
Single pulse avalanche energy (Note 5)	E_{AS}	800	mJ

Operating Junction and Storage Temperature Range	T_J, T_{STG}	-55 To 175	°C
--	----------------	------------	----

Thermal Characteristic

Thermal Resistance, Junction-to-Case(Note 2)	$R_{\theta JC}$	0.75	°C/W
--	-----------------	------	------

Electrical Characteristics (TA=25°C unless otherwise noted)

Parameter	Symbol	Condition	Min	Typ	Max	Unit
Off Characteristics						
Drain-Source Breakdown Voltage	BV_{DSS}	$V_{GS}=0V, I_D=250\mu A$	80	86	-	V
Zero Gate Voltage Drain Current	I_{DSS}	$V_{DS}=80V, V_{GS}=0V$	-	-	1	μA
Gate-Body Leakage Current	I_{GSS}	$V_{GS}=\pm 20V, V_{DS}=0V$	-	-	± 100	nA
On Characteristics (Note 3)						
Gate Threshold Voltage	$V_{GS(th)}$	$V_{DS}=V_{GS}, I_D=250\mu A$	2	3	4	V
Drain-Source On-State Resistance	$R_{DS(ON)}$	$V_{GS}=10V, I_D=40A$	-	6.3	8	m Ω
Forward Transconductance	g_{FS}	$V_{DS}=25V, I_D=40A$	80	-	-	S
Dynamic Characteristics (Note4)						
Input Capacitance	C_{iss}	$V_{DS}=25V, V_{GS}=0V,$ $F=1.0MHz$	-	4900	-	PF
Output Capacitance	C_{oss}		-	410	-	PF
Reverse Transfer Capacitance	C_{rss}		-	315	-	PF
Switching Characteristics (Note 4)						
Turn-on Delay Time	$t_{d(on)}$	$V_{DD}=30V, I_D=2A, R_L=15\Omega,$ $R_G=2.5\Omega, V_{GS}=10V$	-	20	-	nS
Turn-on Rise Time	t_r		-	19	-	nS
Turn-Off Delay Time	$t_{d(off)}$		-	70	-	nS
Turn-Off Fall Time	t_f		-	30	-	nS
Total Gate Charge	Q_g	$I_D=30A, V_{DD}=30V, V_{GS}=10V$	-	125	-	nC
Gate-Source Charge	Q_{gs}		-	24	-	nC
Gate-Drain Charge	Q_{gd}		-	49	-	nC
Drain-Source Diode Characteristics						
Diode Forward Voltage (Note 3)	V_{SD}	$V_{GS}=0V, I_S=40A$	-	-	1.2	V
Diode Forward Current (Note 2)	I_S		-	-	105	A
Reverse Recovery Time	t_{rr}	$T_J=25^\circ C, I_F=75A,$ $di/dt=100A/\mu S$ (Note3)	-	37		nS
Reverse Recovery Charge	Q_{rr}		-	58		nC
Forward Turn-On Time	t_{on}	Intrinsic turn-on time is negligible (turn-on is dominated by LS+LD)				

Notes:

1. Repetitive Rating: Pulse width limited by maximum junction temperature.
2. Surface Mounted on FR4 Board, $t \leq 10$ sec.
3. Pulse Test: Pulse Width $\leq 300\mu s$, Duty Cycle $\leq 2\%$.
4. Guaranteed by design, not subject to production
5. EAS condition: $T_J=25^\circ C, V_{DB}=40V, V_G=10V, L=0.5mH, R_g=25\Omega$

Test circuit

1) E_{AS} test Circuits



2) Gate charge test Circuit:

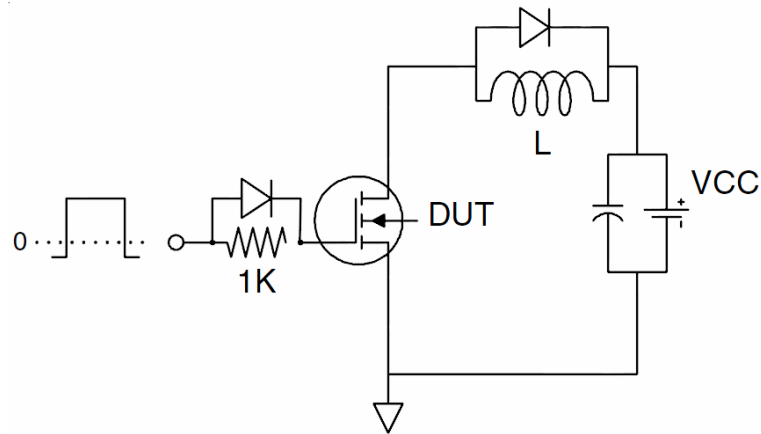

3) Switch Time Test Circuit:

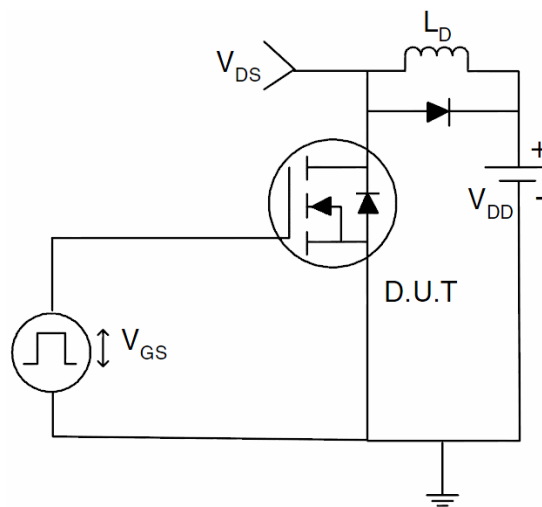

TYPICAL ELECTRICAL AND THERMAL CHARACTERISTICS (Curves)

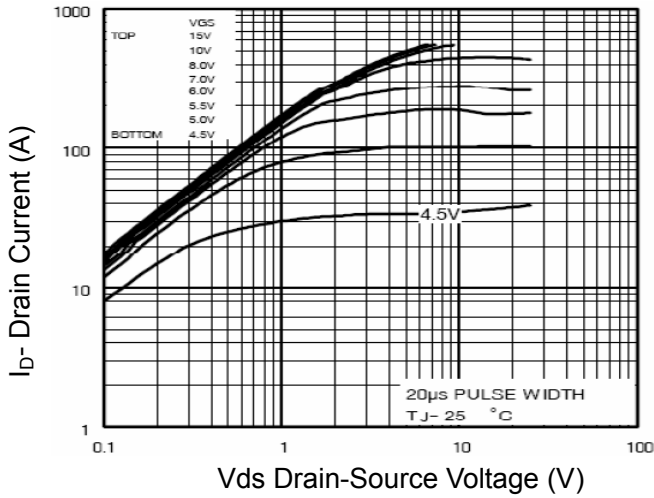

Figure 1 Output Characteristics

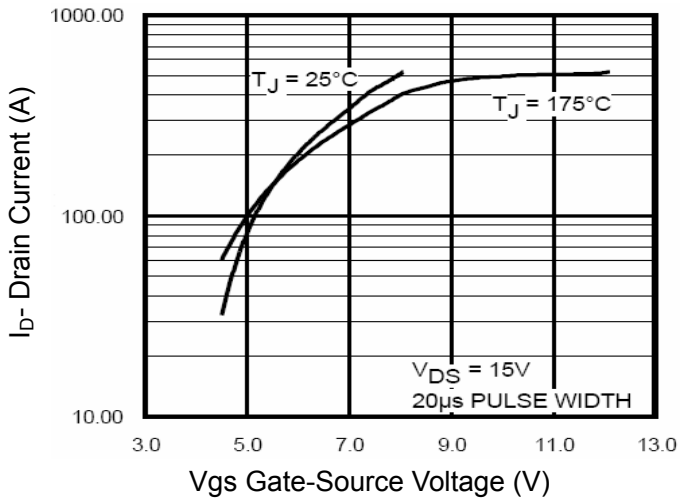

Figure 2 Transfer Characteristics

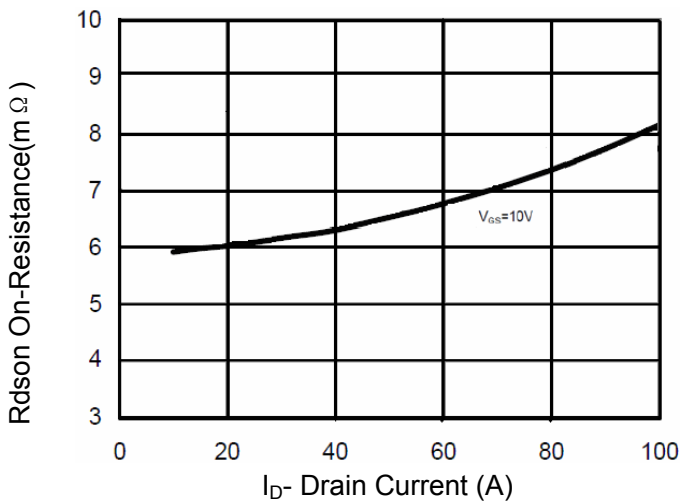

Figure 3 Rdson- Drain Current

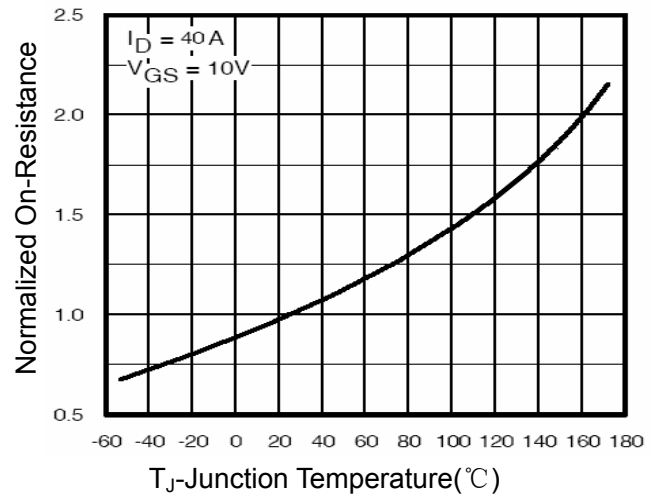

Figure 4 Rdson-Junction Temperature

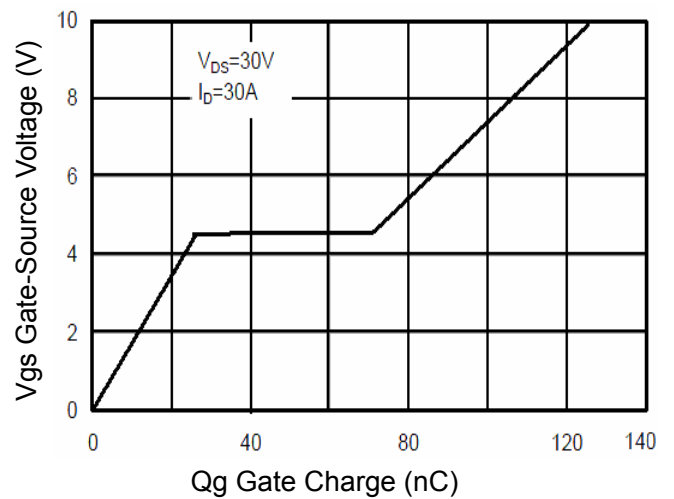

Figure 5 Gate Charge

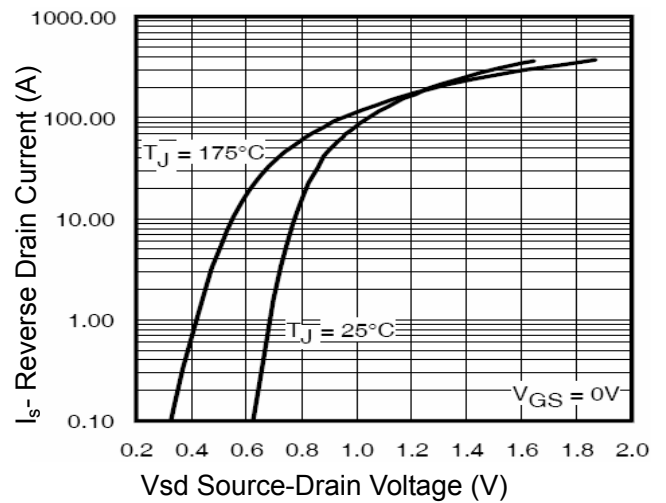

Figure 6 Source- Drain Diode Forward

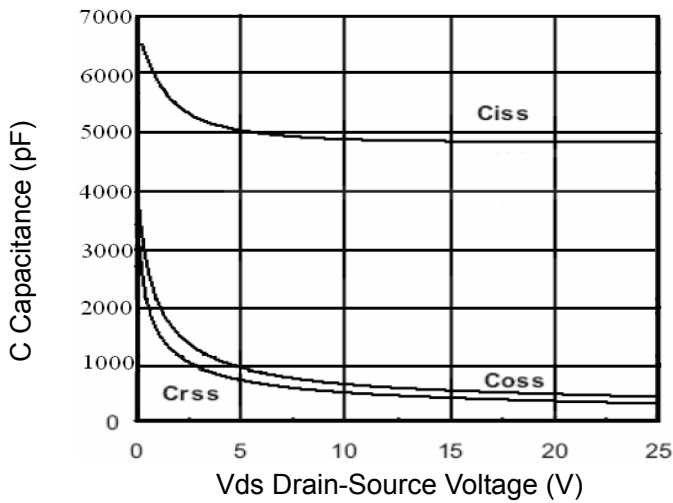

Figure 7 Capacitance vs Vds

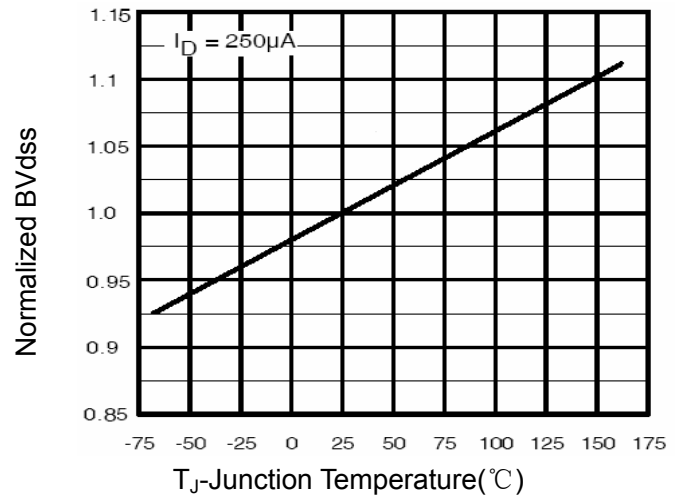

Figure 9 BV_{DSS} vs Junction Temperature

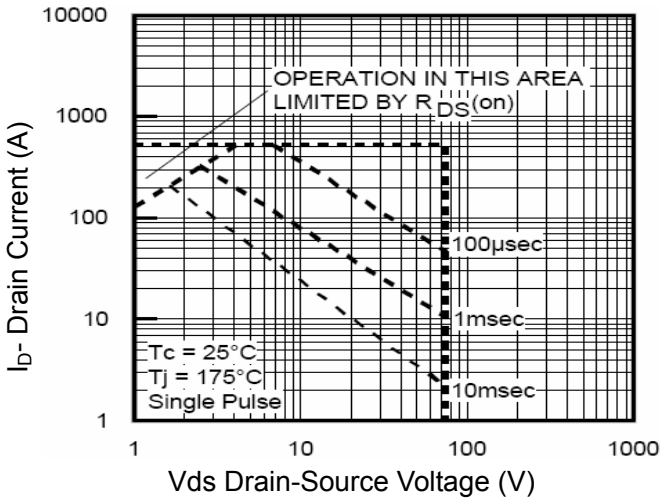

Figure 8 Safe Operation Area

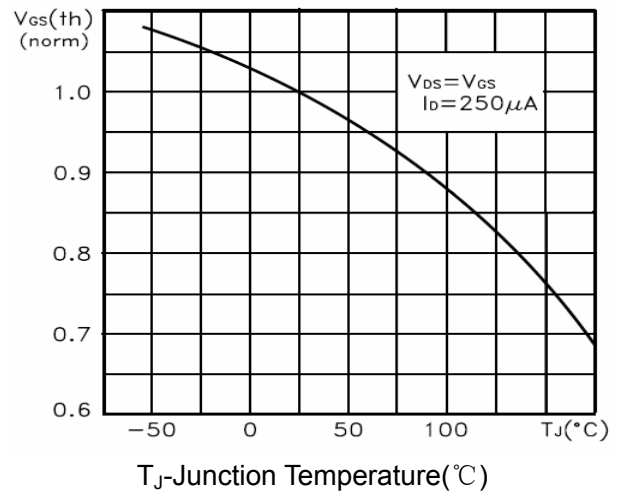

Figure 10 $V_{GS(th)}$ vs Junction Temperature

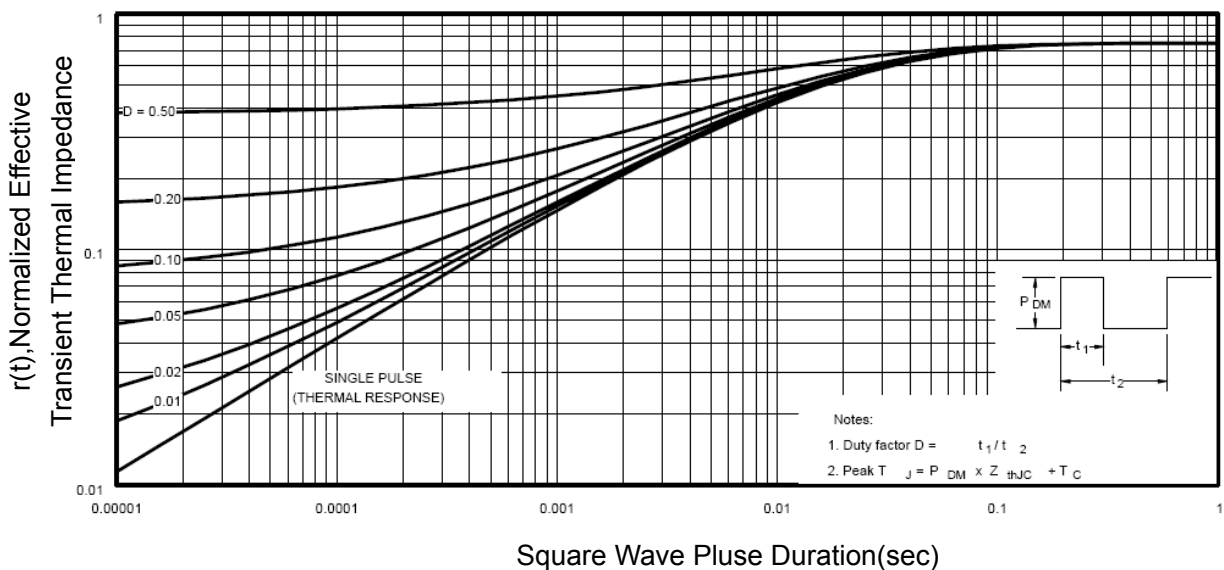
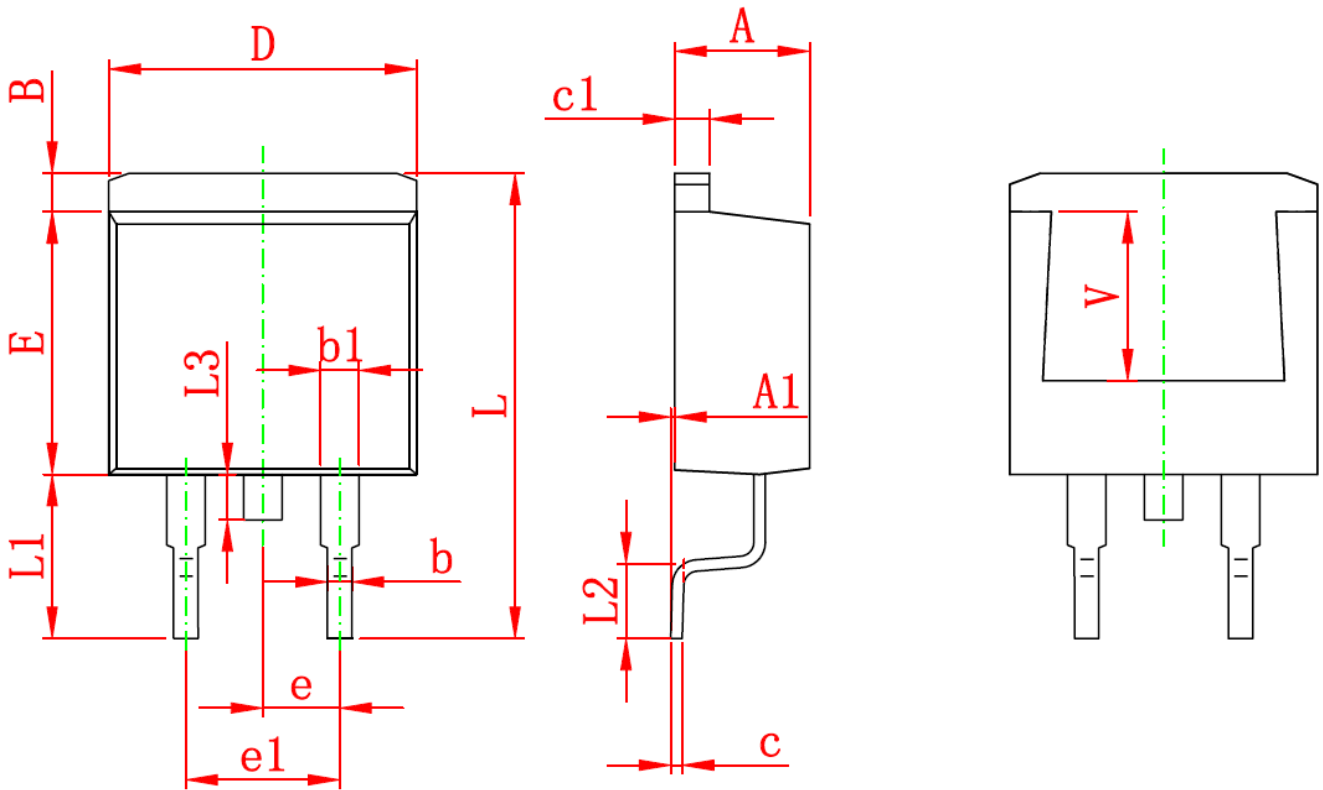

Figure 11 Normalized Maximum Transient Thermal Impedance

TO-263-2L PACKAGE INFORMATION



Symbol	Dimensions In Millimeters		Dimensions In Inches	
	Min	Max	Min	Max
A	4.470	4.670	0.176	0.184
A1	0.000	0.150	0.000	0.006
B	1.170	1.370	0.046	0.054
b	0.710	0.910	0.028	0.036
b1	1.170	1.370	0.046	0.054
c	0.310	0.530	0.012	0.021
c1	1.170	1.370	0.046	0.054
D	10.010	10.310	0.394	0.406
E	8.500	8.900	0.335	0.350
e	2.540 (TYP.)		0.100 (TYP.)	
e1	4.980	5.180	0.196	0.204
L	15.050	15.450	0.593	0.608
L1	5.080	5.480	0.200	0.216
L2	2.340	2.740	0.092	0.108
L3	1.300	1.700	0.051	0.067
V	5.600 REF.		0.220 REF.	