

Description

The PT FEEB-EGS uses advanced trench technology and design to provide excellent $R_{DS(ON)}$ with low gate charge. It can be used in a wide variety of applications.

General Features

- $V_{DS} = 20V, I_D = 100A$
 $R_{DS(ON)} < 5.5m\Omega @ V_{GS} = 4.5V$
- High density cell design for ultra low R_{dson}
- Fully characterized avalanche voltage and current
- Good stability and uniformity with high E_{AS}
- Excellent package for good heat dissipation

Application

- Load switching
- Hard switched and high frequency circuits
- Uninterruptible power supply

100% UIS TESTED!

100% ΔV_{ds} TESTED!

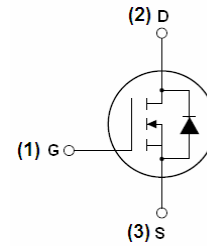

Schematic diagram

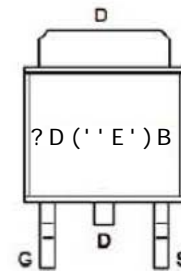

Marking and pin assignment

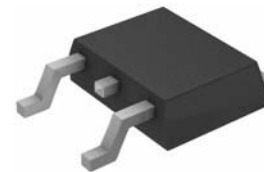

TO-252-2L top view

Package Marking and Ordering Information

Device Marking	Device	Device Package	Reel Size	Tape width	Quantity
PT FEEB-EGS	PT FEEB-EGS	TO-252-2L	-	-	-

Absolute Maximum Ratings ($T_C = 25^\circ C$ unless otherwise noted)

Parameter	Symbol	Limit	Unit
Drain-Source Voltage	V_{DS}	20	V
Gate-Source Voltage	V_{GS}	± 12	V
Drain Current-Continuous	I_D	100	A
Drain Current-Continuous($T_C = 100^\circ C$)	$I_D(100^\circ C)$	70	A
Pulsed Drain Current	I_{DM}	350	A
Maximum Power Dissipation	P_D	60	W
Derating factor		0.48	W/ $^\circ C$
Single pulse avalanche energy (Note 5)	E_{AS}	200	mJ
Operating Junction and Storage Temperature Range	T_J, T_{STG}	-55 To 150	$^\circ C$

Thermal Characteristic

Thermal Resistance, Junction-to-Case (Note 2)	$R_{\theta JC}$	2.1	$^\circ C/W$
---	-----------------	-----	--------------

Electrical Characteristics (T_C=25°C unless otherwise noted)

Parameter	Symbol	Condition	Min	Typ	Max	Unit
Off Characteristics						
Drain-Source Breakdown Voltage	BV _{DSS}	V _{GS} =0V I _D =250μA	20	-	-	V
Zero Gate Voltage Drain Current	I _{DSS}	V _{DS} =20V, V _{GS} =0V	-	-	1	μA
Gate-Body Leakage Current	I _{GSS}	V _{GS} =±12V, V _{DS} =0V	-	-	±100	nA
On Characteristics (Note 3)						
Gate Threshold Voltage	V _{GS(th)}	V _{DS} =V _{GS} , I _D =250μA	0.45	0.65	1.5	V
Drain-Source On-State Resistance	R _{DS(ON)}	V _{GS} =10V, I _D =40 A	-	4.5	5.5	mΩ
		V _{GS} =4.5V, I _D =30A		6.5	7.5	mΩ
Forward Transconductance	g _{FS}	V _{DS} =10V, I _D =40A	15	-	-	S
Dynamic Characteristics (Note4)						
Input Capacitance	C _{iss}	V _{DS} =10V, V _{GS} =0V, F=1.0MHZ	-	2000	-	PF
Output Capacitance	C _{OSS}		-	500	-	PF
Reverse Transfer Capacitance	C _{rss}		-	200	-	PF
Switching Characteristics (Note 4)						
Turn-on Delay Time	t _{d(on)}	V _{DD} =10V, I _D =2A, R _L =1Ω V _{GS} =4.5V, R _G =3Ω	-	6.4	-	nS
Turn-on Rise Time	t _r		-	17.2	-	nS
Turn-Off Delay Time	t _{d(off)}		-	29.6	-	nS
Turn-Off Fall Time	t _f		-	16.8	-	nS
Total Gate Charge	Q _g	V _{DS} =10V, I _D =40A, V _{GS} =10V	-	27		nC
Gate-Source Charge	Q _{gs}		-	6.5		nC
Gate-Drain Charge	Q _{gd}		-	6.4		nC
Drain-Source Diode Characteristics						
Diode Forward Voltage (Note 3)	V _{SD}	V _{GS} =0V, I _S =20A	-		1.2	V
Diode Forward Current (Note 2)	I _S		-	-	100	A
Reverse Recovery Time	t _{rr}	T _J = 25°C, I _F = 40A di/dt = 100A/μs (Note3)	-	25	-	nS
Reverse Recovery Charge	Q _{rr}		-	24	-	nC
Forward Turn-On Time	t _{on}	Intrinsic turn-on time is negligible (turn-on is dominated by LS+LD)				

Notes:

1. Repetitive Rating: Pulse width limited by maximum junction temperature.
2. Surface Mounted on FR4 Board, t ≤ 10 sec.
3. Pulse Test: Pulse Width ≤ 300μs, Duty Cycle ≤ 2%.
4. Guaranteed by design, not subject to production
5. E_{AS} condition : T_J=25°C, V_{DD}=10V, V_G=10V, L=0.5mH, R_g=25Ω.

Test circuit

1) E_{AS} Test Circuit



2) Gate Charge Test Circuit

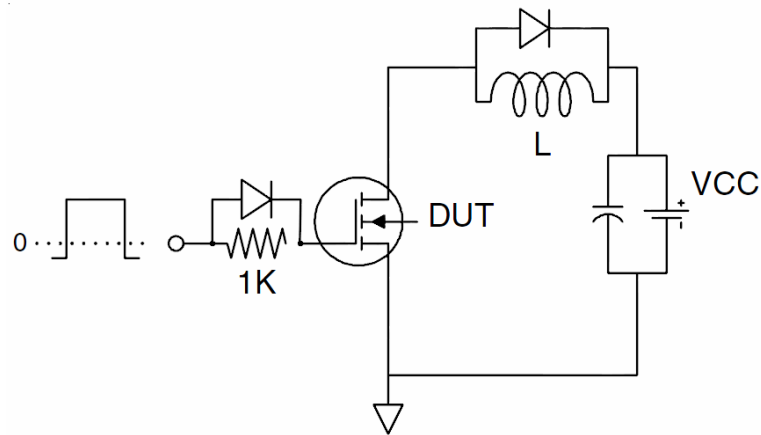

3) Switch Time Test Circuit

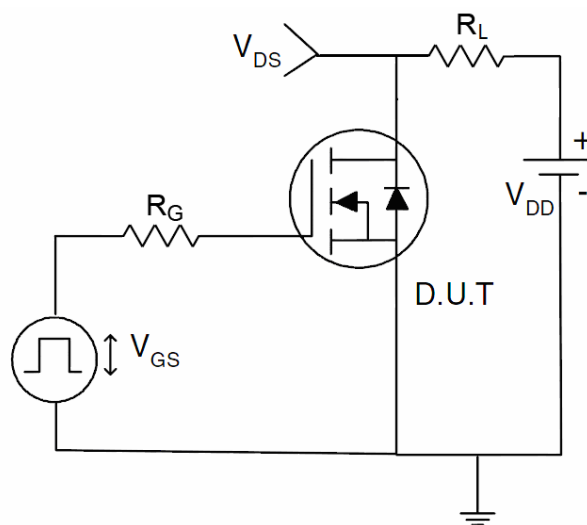

Typical Electrical and Thermal Characteristics (Curves)

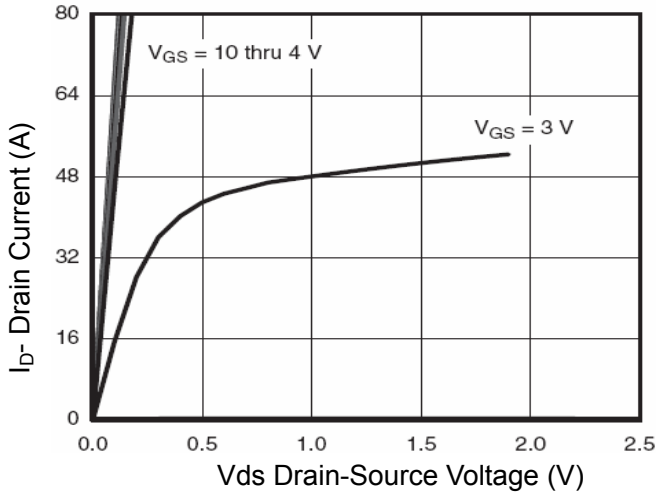

Figure 1 Output Characteristics

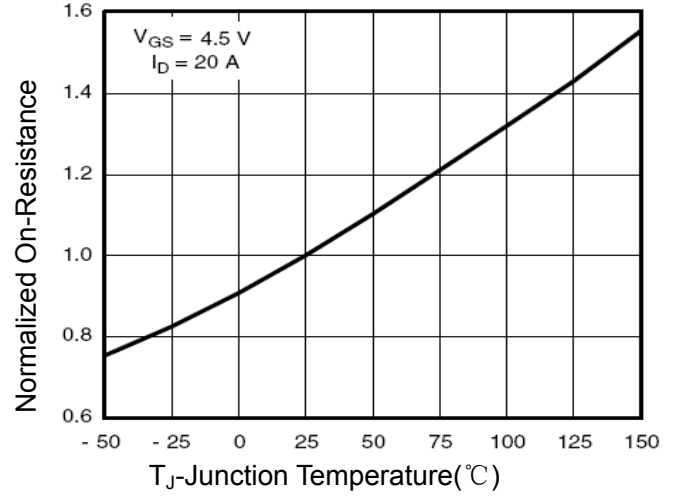

Figure 4 Rds(on)-Junction Temperature

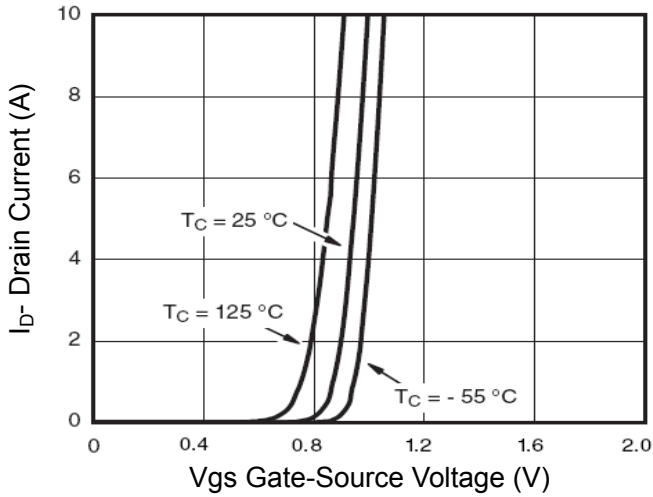

Figure 2 Transfer Characteristics

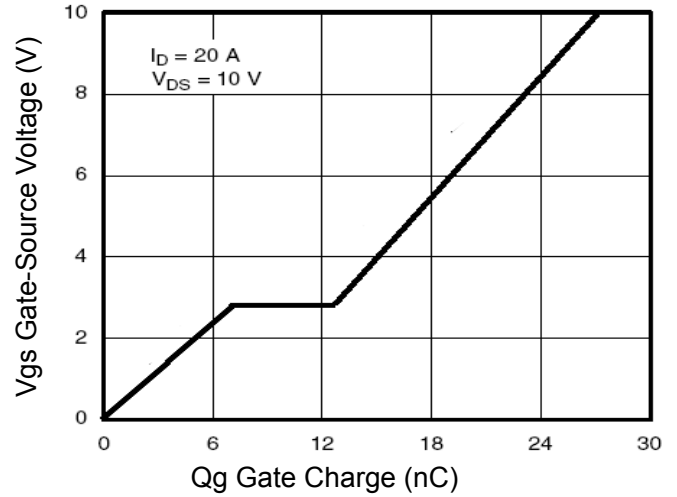

Figure 5 Gate Charge

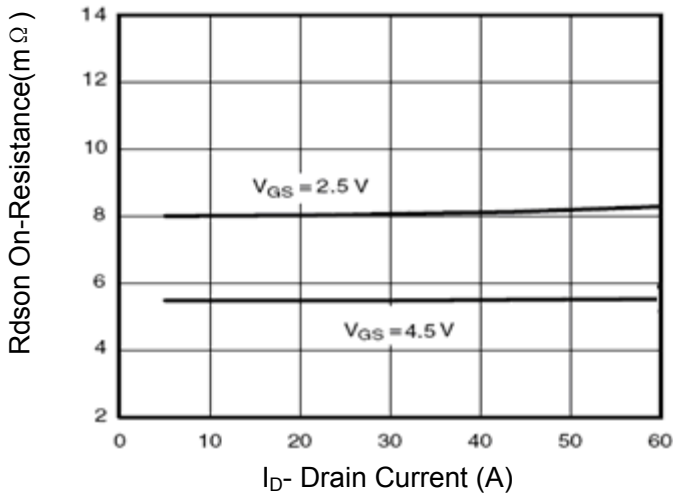

Figure 3 Rds(on)- Drain Current

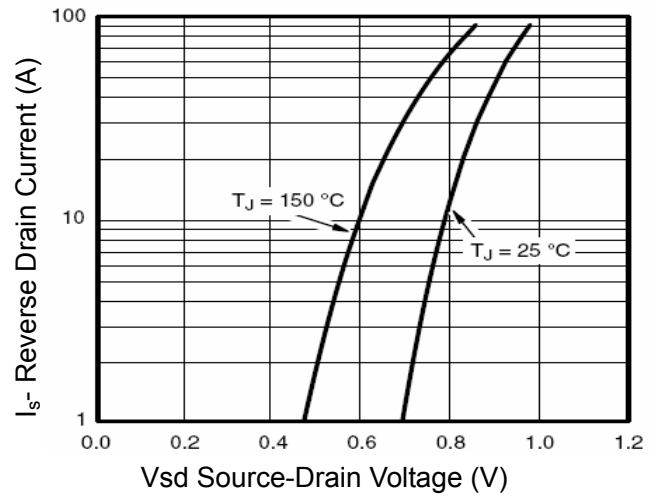

Figure 6 Source- Drain Diode Forward

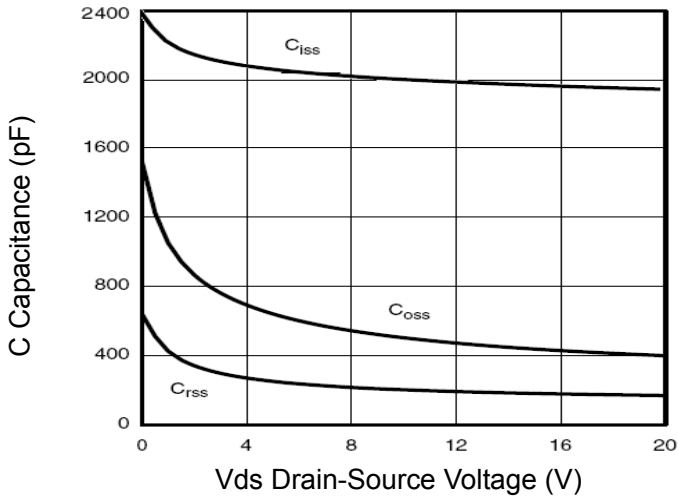

Figure 7 Capacitance vs Vds

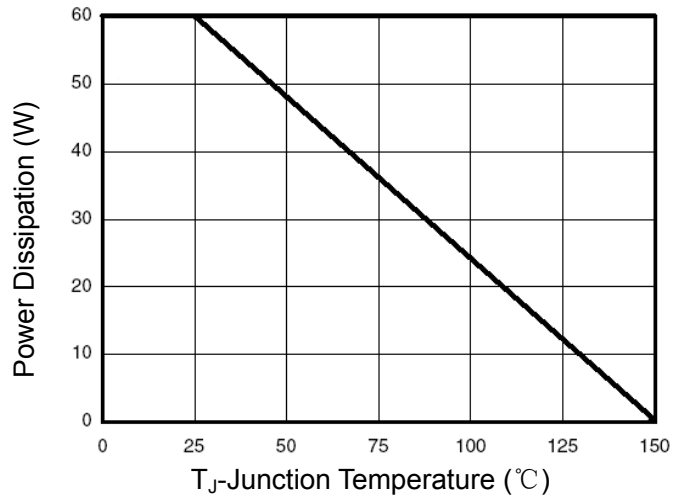

Figure 9 Power De-rating

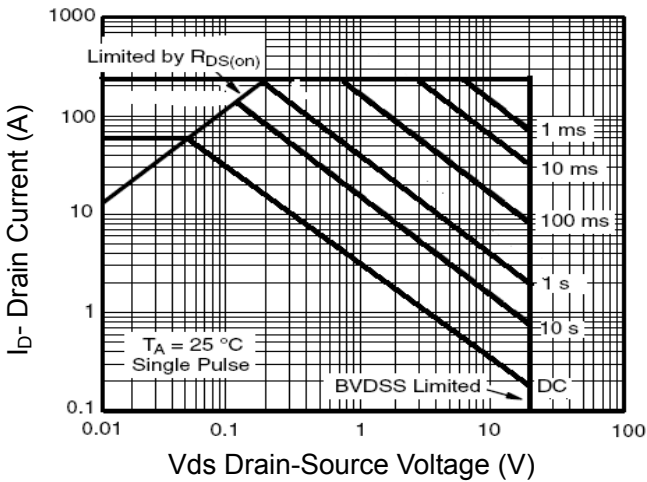

Figure 8 Safe Operation Area

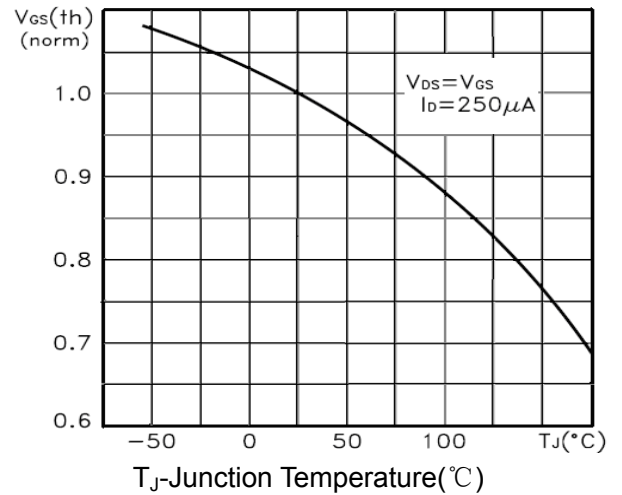

Figure 10 $V_{GS(th)}$ vs Junction Temperature

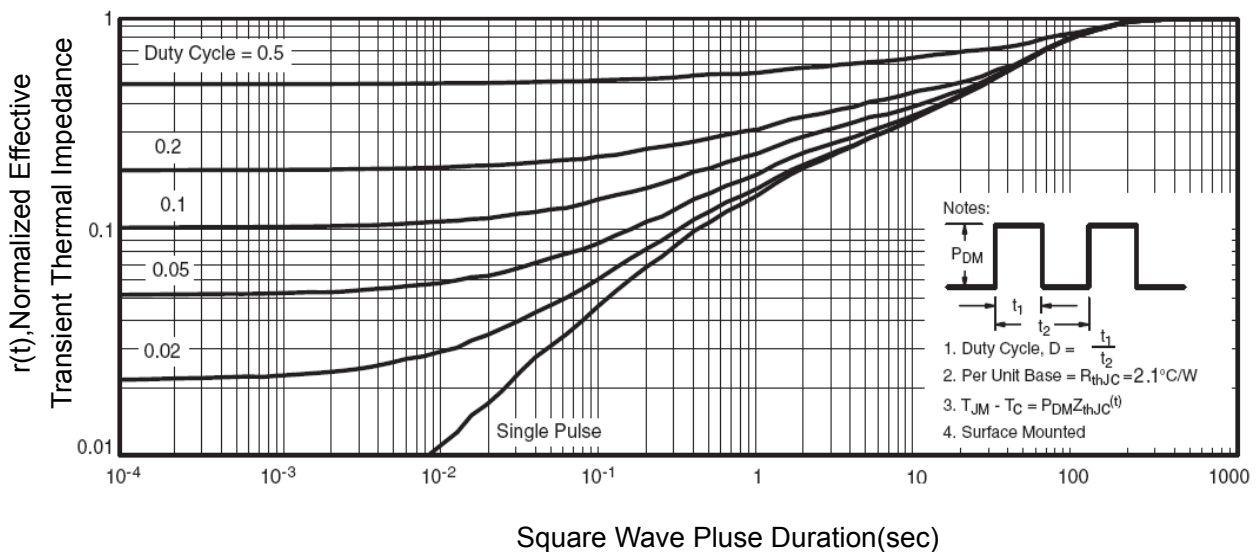
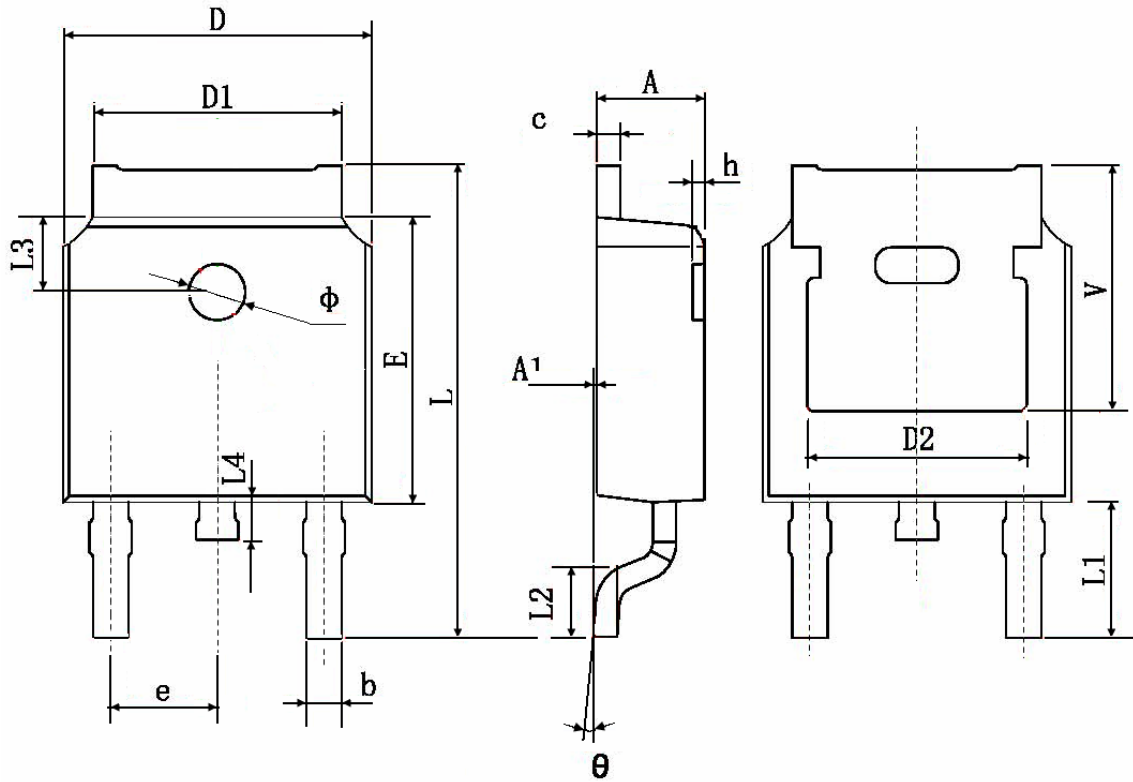

Figure 11 Normalized Maximum Transient Thermal Impedance

TO-252 Package Information



Symbol	Dimensions In Millimeters		Dimensions In Inches	
	Min.	Max.	Min.	Max.
A	2.200	2.400	0.087	0.094
A1	0.000	0.127	0.000	0.005
b	0.660	0.860	0.026	0.034
c	0.460	0.580	0.018	0.023
D	6.500	6.700	0.256	0.264
D1	5.100	5.460	0.201	0.215
D2	0.483 TYP.		0.190 TYP.	
E	6.000	6.200	0.236	0.244
e	2.186	2.386	0.086	0.094
L	9.800	10.400	0.386	0.409
L1	2.900 TYP.		0.114 TYP.	
L2	1.400	1.700	0.055	0.067
L3	1.600 TYP.		0.063 TYP.	
L4	0.600	1.000	0.024	0.039
phi	1.100	1.300	0.043	0.051
theta	0°	8°	0°	8°
h	0.000	0.300	0.000	0.012
V	5.350 TYP.		0.211 TYP.	