



UT138FF/FG

TRIAC

TRIAC

■ **DESCRIPTION**

Glass passivated triac in a full pack plastic envelope, intended for use in applications requiring high bidirectional transient and blocking voltage capability and high thermal cycling performance. Typical applications include motor control, industrial and domestic lighting, heating and static switching.

■ **SYMBOL**

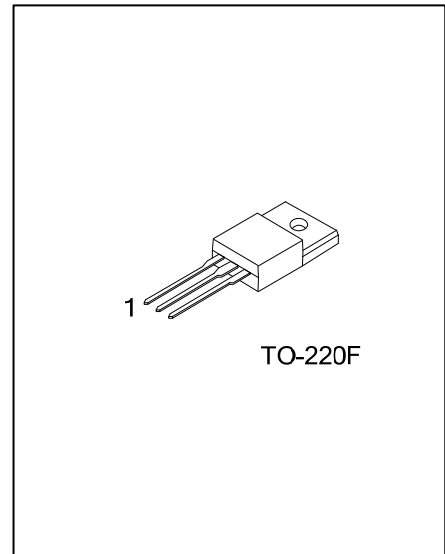
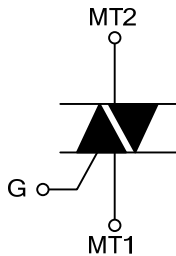

■ **ORDERING INFORMATION**

Ordering Number		Package	Pin Description			Packing
Lead Free	Halogen Free		1	2	3	
UT138FFL-x-TF3-R	UT138FFG-x-TF3-R	TO-220F	MT1	MT2	G	Tube
UT138FGL-x-TF3-R	UT138FGP-x-TF3-R	TO-220F	MT1	MT2	G	Tube

Note: Pin Assignment: G: Gate

<p>UT138FFL-x-TF3-T</p> <ul style="list-style-type: none"> (1) Packing Type (2) Package Type (3) Peak Voltage (4) Green Package 	<ul style="list-style-type: none"> (1) T: Tube (2) TF3: TO-220F (3) 5: 500V, 6: 600V, 8: 800V (4) L: Lead Free, G: Halogen Free and Lead Free P: Halogen Free and Lead Free
---	--

■ **MARKING**

UT138FF	UT138FG

■ ABSOLUTE MAXIMUM RATING

PARAMETER		SYMBOL	RATINGS	UNIT
Repetitive Peak Off-State Voltages	UT138FF/FG-5	V_{DRM}	500(Note2)	V
	UT138FF/FG-6		600(Note2)	
	UT138FF/FG-8		800	
RMS On-state Current Full sine wave, $T_{HS} \leq 92^{\circ}C$		$I_{T(RMS)}$	12	A
Non-Repetitive Peak. On-State Current Full sine wave, $T_J = 125^{\circ}C$ prior to surge, with reapplied $V_{DRM(MAX)}$	$t = 20$ ms	I_{TSM}	90	A
	$t = 16.7$ ms		100	
I^2t For Fusing ($t = 10$ ms)		I^2t	40	A^2s
Repetitive Rate of Rise of On-state Current after Triggering $I_{TM} = 12$ A, $I_G = 0.2$ A, $dI_G/dt = 0.2A/\mu s$	T2 + G+	dI_T/dt	50	A/ μs
	T2 + G-		50	
	T2 - G-		50	
	T2 - G+		10	
Peak Gate Voltage		V_{GM}	5	V
Peak Gate Current		I_{GM}	2	A
Peak Gate Power		P_{GM}	5	W
Average Gate Power (Over any 20ms period)		$P_{G(AV)}$	0.5	W
Operating Junction Temperature		T_J	125	$^{\circ}C$
Storage Temperature		T_{STG}	-40 ~ +150	$^{\circ}C$

Notes: 1. Absolute maximum ratings are those values beyond which the device could be permanently damaged. Absolute maximum ratings are stress ratings only and functional device operation is not implied.

2. Although not recommended, off-state voltages up to 800V may be applied without damage, but the triac may switch to the on-state. The rate of rise of current should not exceed 15A/ μs .

■ THERMAL RESISTANCES

PARAMETER		SYMBOL	MIN	TYP	MAX	UNIT
Thermal resistance Junction to Ambient	In Free Air	θ_{JA}		55		$^{\circ}C/W$
Thermal resistance Junction to mounting base	Full cycle	θ_{JC}			4.0	$^{\circ}C/W$
	Half cycle				5.5	$^{\circ}C/W$

■ ISOLATION LIMITING VALUE & CHARACTERISTIC ($T_{HS} = 25^{\circ}C$, unless otherwise specified)

PARAMETER		SYMBOL	MIN	TYP	MAX	UNIT
Repetitive peak voltage from all three terminals to external heatsink (R.H. $\leq 65\%$, clean and dustfree)		V_{ISOL}			1500	V
Capacitance from MT2 to external heatsink ($f = 1$ MHz)		C_{ISOL}		12		pF

■ STATIC CHARACTERISTICS ($T_J = 25^{\circ}C$, unless otherwise specified)

PARAMETER	SYMBOL	TEST CONDITIONS	MIN	TYP	MAX		UNIT
					UT138FF	UT138FG	
Gate Trigger Current	I_{GT}	$V_D = 12$ V, $I_T = 0.1$ A	T2 + G+	5	25	50	mA
			T2 + G-	8	25	50	mA
			T2 - G-	10	25	50	mA
			T2 - G+	22	70	100	mA
Latching Current	I_L	$V_D = 12$ V, $I_{GT} = 0.1$ A	T2 + G+	7	40	60	mA
			T2 + G-	20	60	90	mA
			T2 - G-	8	40	60	mA
			T2 - G+	10	60	90	mA
Holding Current	I_H	$V_D = 12$ V, $I_{GT} = 0.1$ A		6	30	60	mA
On-State Voltage	V_T	$I_T = 15$ A		1.4	1.65		V
Gate Trigger Voltage	V_{GT}	$V_D = 12$ V, $I_T = 0.1$ A		0.7	1.5		V
		$V_D = 400$ V, $I_T = 0.1$ A, $T_J = 125^{\circ}C$	0.25	0.4			V
Off-State Leakage Current	I_D	$V_D = V_{DRM(MAX)}$, $T_J = 125^{\circ}C$		0.1	0.5		mA

■ DYNAMIC CHARACTERISTICS (T_J=25°C, unless otherwise specified)

PARAMETER	SYMBOL	TEST CONDITIONS	MIN		TYP	MAX	UNIT
			UT138FF	UT138FG			
Critical Rate of Rise of Off-State Voltage	dV _D /dt	V _{DM} = 67% V _{DRM(MAX)} , T _J =125°C, exponential waveform, gate open circuit	100	200	250		V/μs
Critical Rate of Change of Commutating Voltage	dV _{COM} /dt	V _{DM} =400V, T _J =95°C, I _{T(RMS)} =12A, dI _{COM} /dt=5.4A/ms, gate open circuit			20		V/μs
Gate Controlled Turn-On Time	t _{GT}	I _{TM} = 16A, V _D = V _{DRM(MAX)} , I _G =0.1A, dI _G /dt=5A/μs			2		μs

■ TYPICAL CHARACTERISTICS

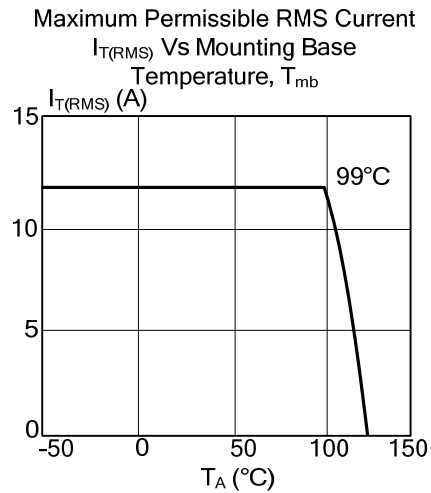
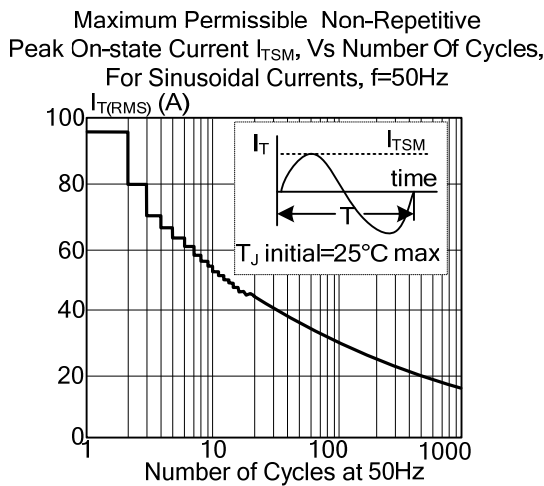
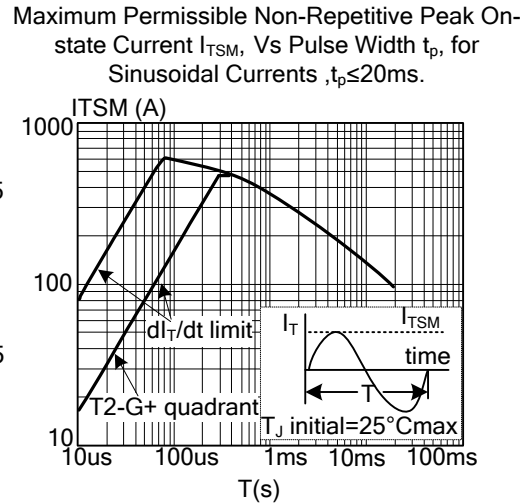
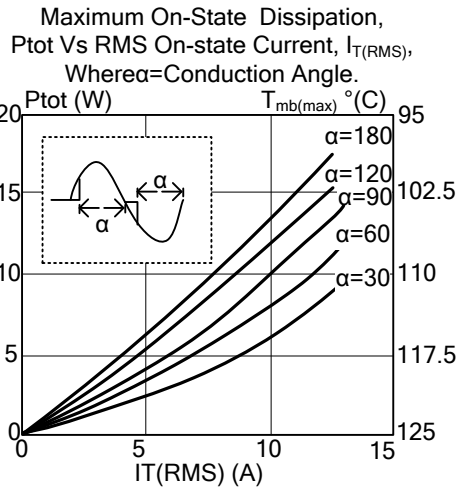

Maximum Permissible Repetitive RMS On-state Current $I_{T(RMS)}$, Vs Surge Duration, For Sinusoidal Currents, $f=50Hz$, $T_{MP} \leq 99^\circ C$

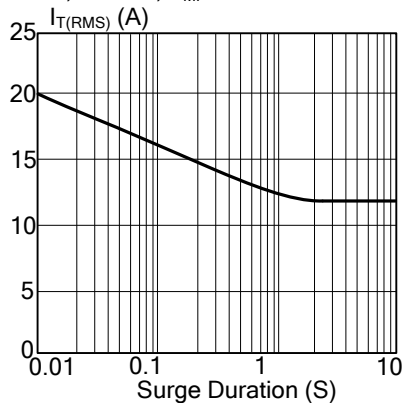

Normalised Gate Trigger Voltage $V_{GT(T_J)}/V_{GT(25^\circ C)}$, Vs Junction Temperature, T_J

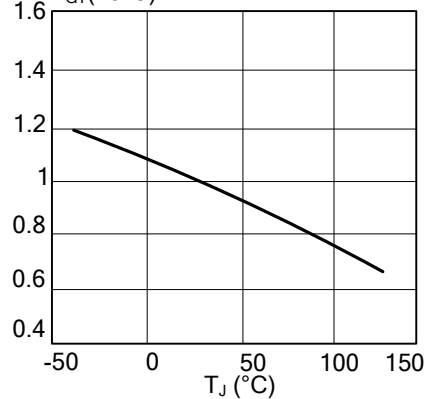

■ TYPICAL CHARACTERISTICS(Cont.)

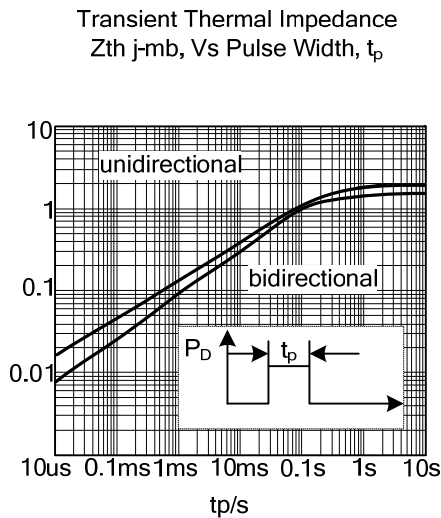
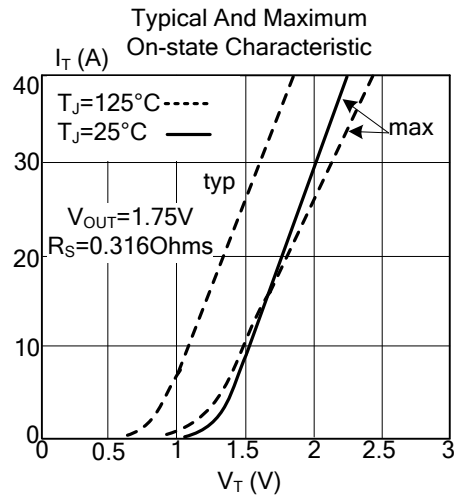
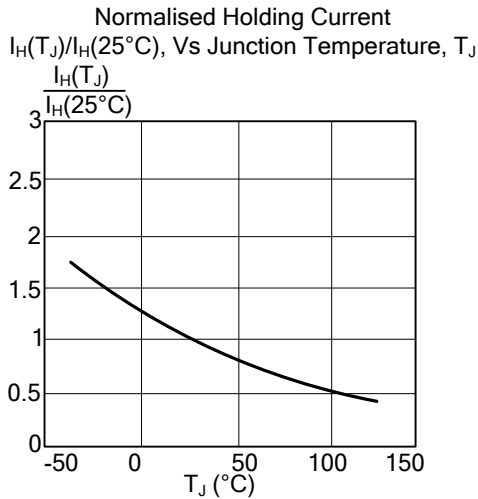
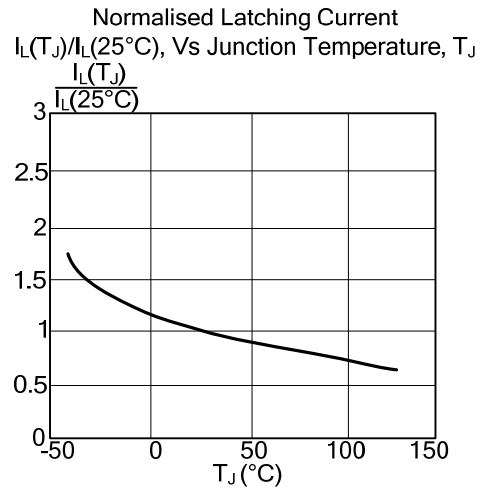
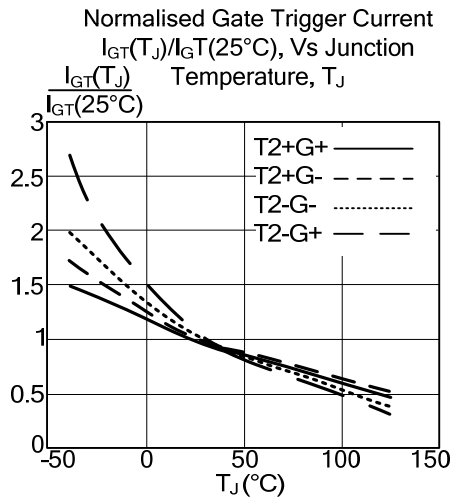

Typical Commutation dV/dt Vs Junction Temperature, Parameter Commutation dI_T/dt .
 The Triac Should Commutate When The dV/dt Is Below The Value On The Appropriate Curve For Pre-Commutation dI/dt

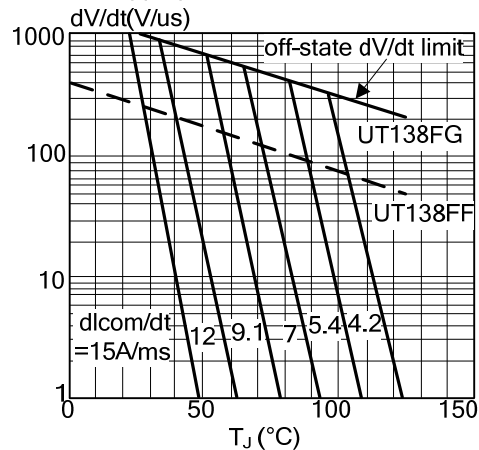

UTC assumes no responsibility for equipment failures that result from using products at values that exceed, even momentarily, rated values (such as maximum ratings, operating condition ranges, or other parameters) listed in products specifications of any and all UTC products described or contained herein. UTC products are not designed for use in life support appliances, devices or systems where malfunction of these products can be reasonably expected to result in personal injury. Reproduction in whole or in part is prohibited without the prior written consent of the copyright owner. The information presented in this document does not form part of any quotation or contract, is believed to be accurate and reliable and may be changed without notice.