



UTD484

Power MOSFET

N-CHANNEL ENHANCEMENT MODE FIELD EFFECT TRANSISTOR

DESCRIPTION

The **UTD484** uses advanced trench technology to provide excellent $R_{DS(ON)}$, low gate charge and operation with low gate voltages. This device is suitable for use as a load switch or in PWM applications.

FEATURES

- * $R_{DS(ON)} < 15m\Omega @ V_{GS} = 10V, I_D = 20A$
- * Low capacitance
- * Low gate charge
- * Fast switching capability
- * Avalanche energy specified

SYMBOL

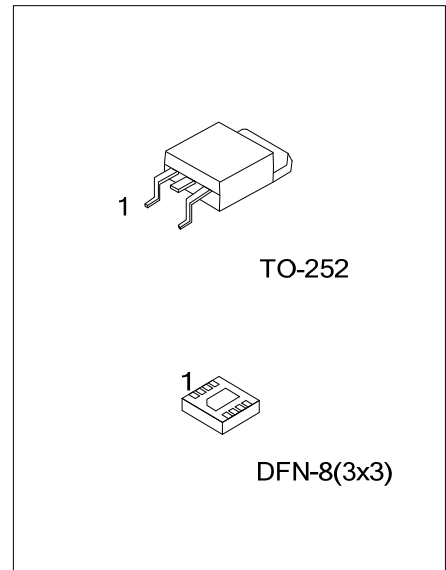
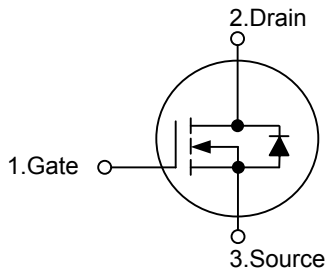

ORDERING INFORMATION

Ordering Number		Package	Pin Assignment								Packing
Lead Free	Halogen Free		1	2	3	4	5	6	7	8	
UTD484L-TN3-T	UTD484G-TN3-T	TO-252	G	D	S	-	-	-	-	-	Tube
UTD484L-TN3-R	UTD484G-TN3-R	TO-252	G	D	S	-	-	-	-	-	Tape Reel
-	UTD484G-K08-3030-R	DFN-8(3x3)	S	S	S	G	D	D	D	D	Tape Reel

Note: Pin Assignment: G: Gate D: Drain S: Source

<p>UTD484L-TN3-R</p> <p>(1)Packing Type</p> <p>(2)Package Type</p> <p>(3)Green Package</p>	<p>(1) R: Tape Reel</p> <p>(2) TN3: TO-252, K08-3030: DFN8(3x3)</p> <p>(3) L: Lead Free, G: Halogen Free and Lead Free</p>
--	--

■ MARKING

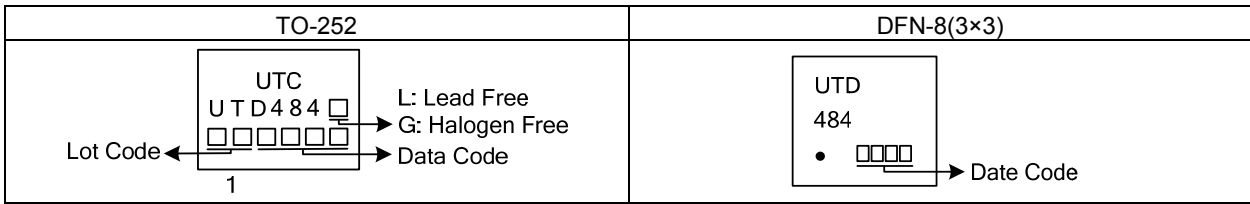

■ ABSOLUTE MAXIMUM RATINGS ($T_A = 25^\circ\text{C}$, unless otherwise specified)

PARAMETER		SYMBOL	RATINGS	UNIT
Drain-Source Voltage		V_{DSS}	30	V
Gate-Source Voltage		V_{GSS}	± 20	V
Continuous Drain Current	$T_C = 25^\circ\text{C}$	I_D	25	A
Pulsed Drain Current(Note 1)		I_{DM}	80	A
Avalanche Current(Note 1)		I_{AR}	15	A
Repetitive avalanche energy $L=0.3\text{mH}$ (Note 1)		E_{AR}	33	mJ
Power Dissipation	$T_C = 25^\circ\text{C}$	TO-252	P_D	W
		DFN-8(3×3)		
	$T_A = 25^\circ\text{C}$	TO-252		
DFN-8(3×3) (Notes 3)		1.9		
Junction Temperature		T_J	+150	$^\circ\text{C}$
Storage Temperature		T_{STG}	-55 ~ +175	$^\circ\text{C}$

Notes: 1. Absolute maximum ratings are those values beyond which the device could be permanently damaged.

Absolute maximum ratings are stress ratings only and functional device operation is not implied.

2. Pulse width limited by $T_{J(MAX)}$

3. Exposed pad is ground and must be soldered to PCB

■ THERMAL DATA

PARAMETER		SYMBOL	MIN	TYP	MAX	UNIT
Junction-to-Ambient	TO-252	θ_{JA}		55	60	$^\circ\text{C/W}$
	DFN-8(3×3)				65	$^\circ\text{C/W}$
Junction-to-Case	TO-252/DFN-8(3×3)	θ_{JC}		2.3	3	$^\circ\text{C/W}$

■ ELECTRICAL CHARACTERISTICS (T_J =25°C, unless otherwise specified)

PARAMETER	SYMBOL	TEST CONDITIONS	MIN	TYP	MAX	UNIT
OFF CHARACTERISTICS						
Drain-Source Breakdown Voltage	BV _{DSS}	V _{GS} =0 V, I _D =250 μA	30			V
Drain-Source Leakage Current	I _{DSS}	V _{DS} =24V, V _{GS} =0 V			1	μA
Gate-Body Leakage Current	I _{GSS}	V _{DS} =0 V, V _{GS} = ±20V			±100	nA
ON CHARACTERISTICS						
Gate Threshold Voltage	V _{GS(TH)}	V _{DS} =V _{GS} , I _D =250 μA	1	1.5	2.5	V
On State Drain Current	I _{D(ON)}	V _{DS} =5 V, V _{GS} =10V	80			A
Static Drain-Source On-Resistance	R _{DS(ON)}	V _{GS} =10 V, I _D =20 A		12.1	15	mΩ
		V _{GS} =4.5 V, I _D =15 A		18.5	23	
DYNAMIC PARAMETERS						
Input Capacitance	C _{ISS}	V _{DS} =15 V, V _{GS} =0V, f=1MHz		938	1220	pF
Output Capacitance	C _{OSS}			142		
Reverse Transfer Capacitance	C _{RSS}			99		
SWITCHING PARAMETERS						
Total Gate Charge	Q _G	V _{DS} =15V, V _{GS} =10V, I _D =20 A		17.5	21	nC
Gate Source Charge	Q _{GS}			3		
Gate Drain Charge	Q _{GD}			4.1		
Turn-ON Delay Time	t _{D(ON)}	V _{GS} =10V, V _{DS} =15V, R _L =0.75Ω, R _{GEN} =3Ω		5		ns
Turn-ON Rise Time	t _R			12		
Turn-OFF Delay Time	t _{D(OFF)}			19		
Turn-OFF Fall-Time	t _F			6		
SOURCE- DRAIN DIODE RATINGS AND CHARACTERISTICS						
Diode Forward Voltage	V _{SD}	I _S =1A, V _{GS} =0V		0.71	1	V
Maximum Body-Diode Continuous Current	I _S				21	A
Body Diode Reverse Recovery Time	t _{RR}	I _F =20 A, dI/dt=100A/μs		19	21	ns
Body Diode Reverse Recovery Charge	Q _{RR}				10	12

TYPICAL CHARACTERISTICS

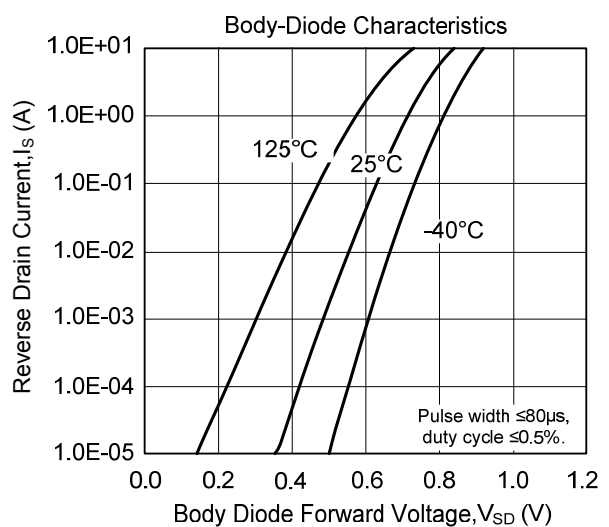
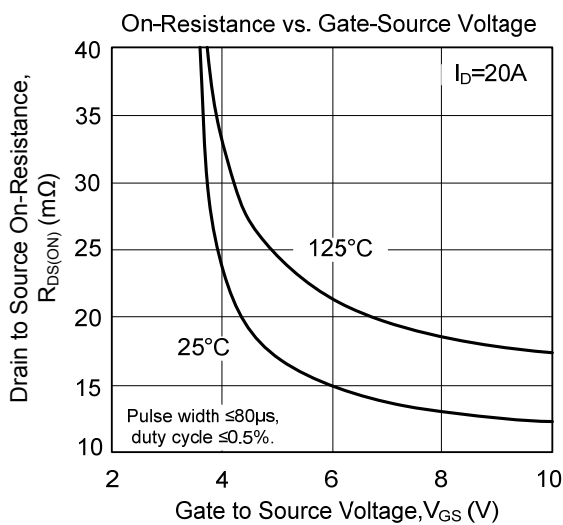
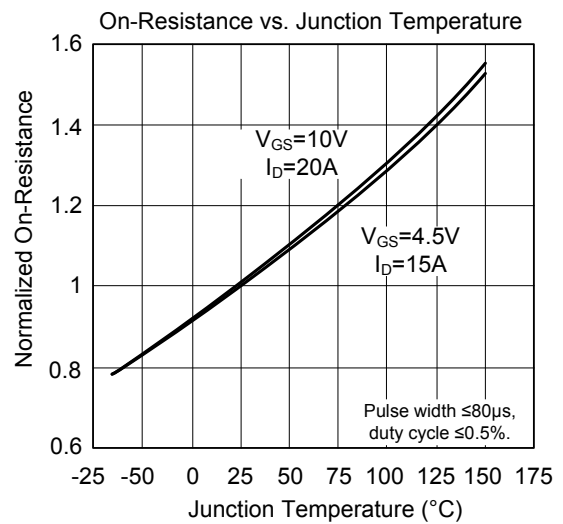
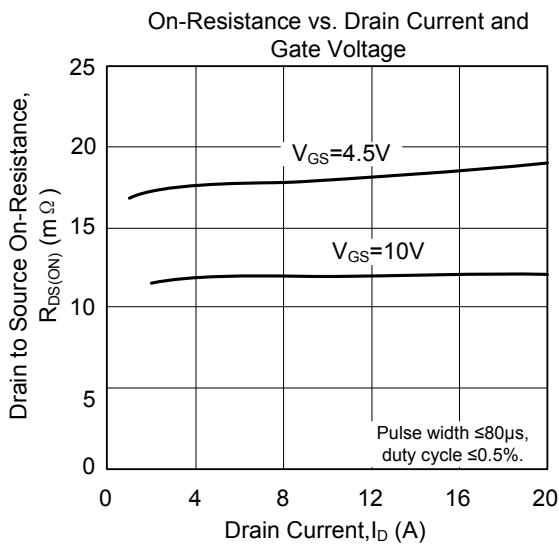
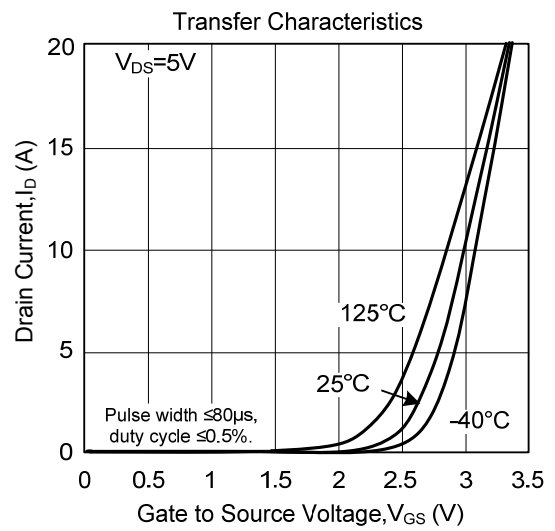
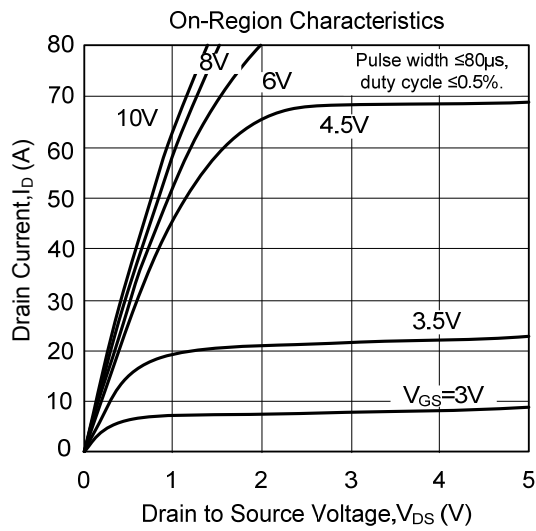

■ TYPICAL CHARACTERISTICS(Cont.)

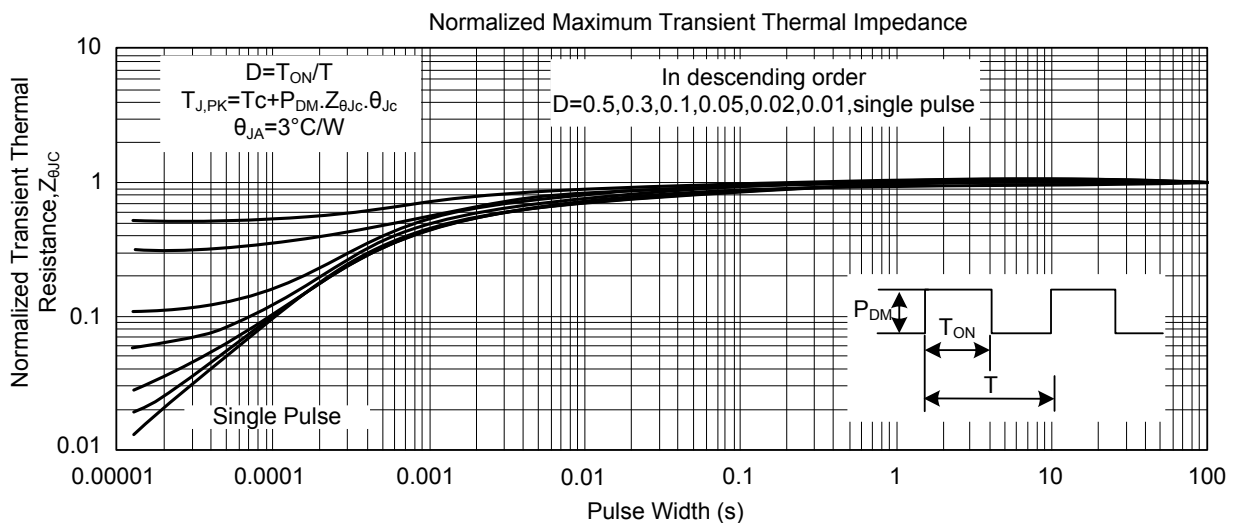
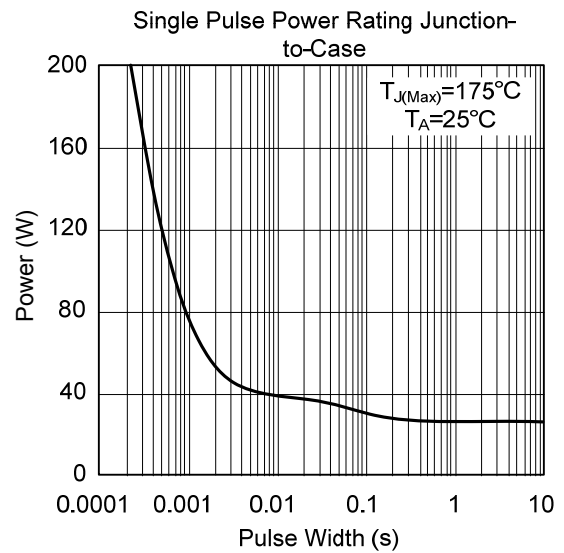
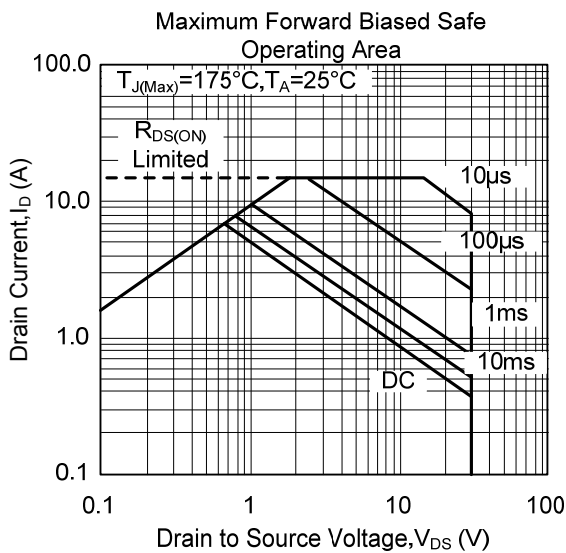
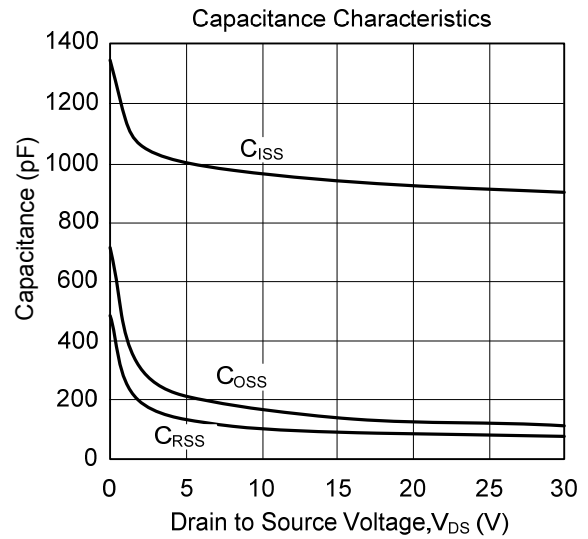
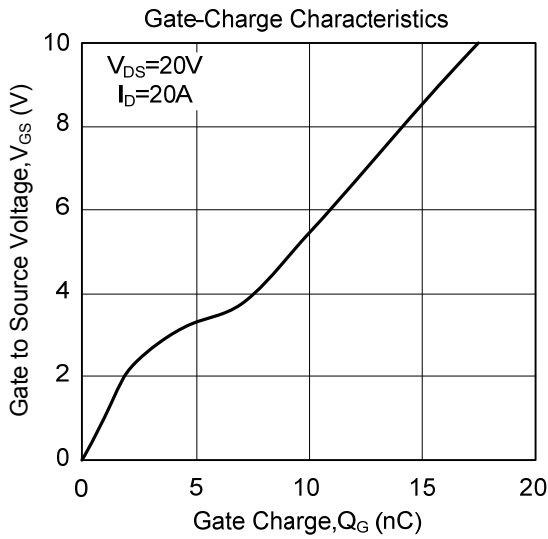

■ TYPICAL CHARACTERISTICS(Cont.)

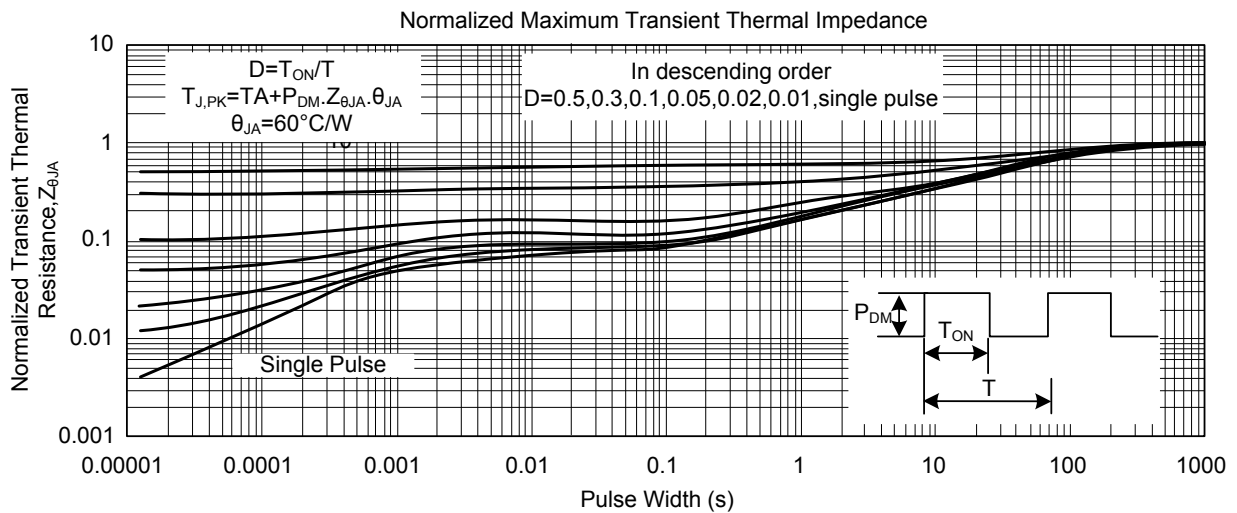
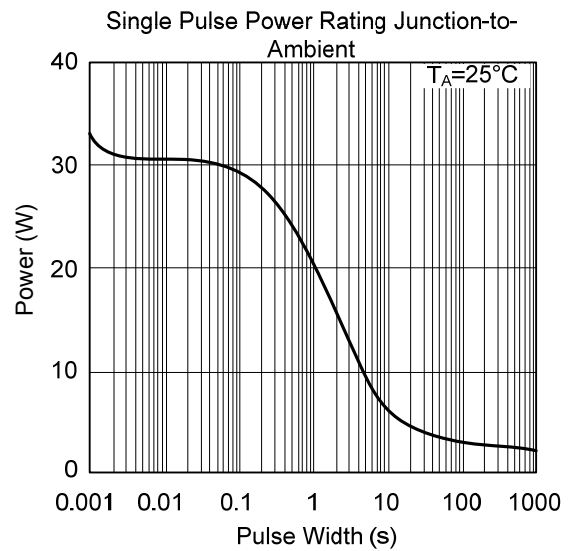
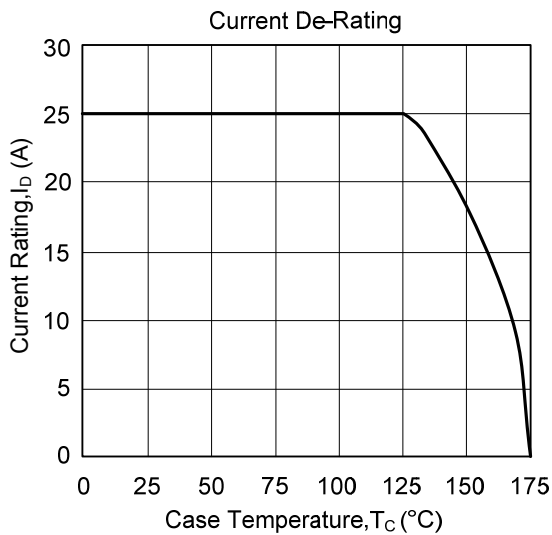
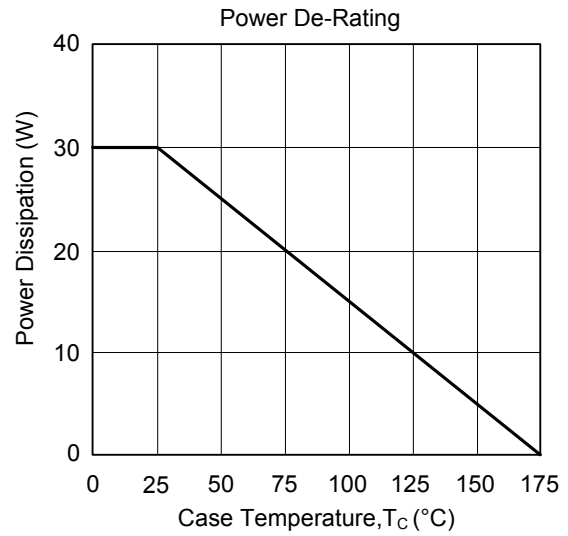
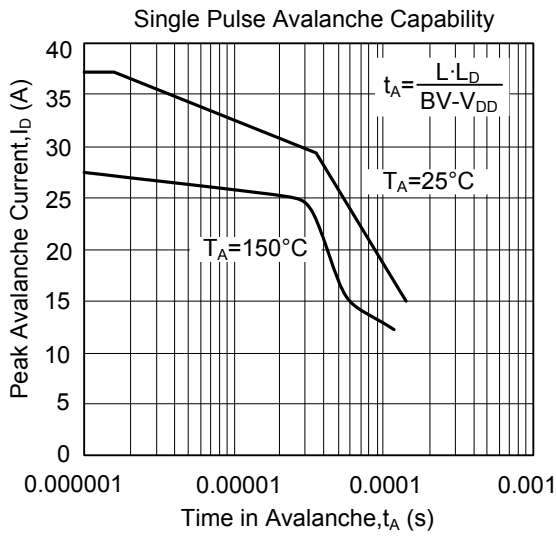

UTC assumes no responsibility for equipment failures that result from using products at values that exceed, even momentarily, rated values (such as maximum ratings, operating condition ranges, or other parameters) listed in products specifications of any and all UTC products described or contained herein. UTC products are not designed for use in life support appliances, devices or systems where malfunction of these products can be reasonably expected to result in personal injury. Reproduction in whole or in part is prohibited without the prior written consent of the copyright owner. The information presented in this document does not form part of any quotation or contract, is believed to be accurate and reliable and may be changed without notice.