



# UT9435

*Power MOSFET*

## P-CHANNEL ENHANCEMENT MODE

■ DESCRIPTION

The **UT9435** is P-Channel Power MOSFET, designed with high density cell with fast switching speed, ultra low on-resistance, and excellent thermal and electrical capabilities.

Used in commercial and industrial surface mount applications and suited for low voltage applications such as DC/DC converters.

■ SYMBOL

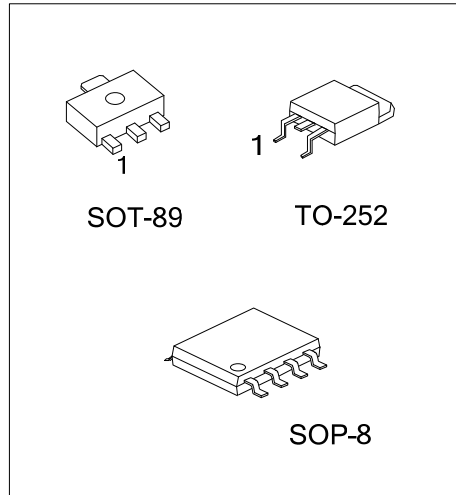
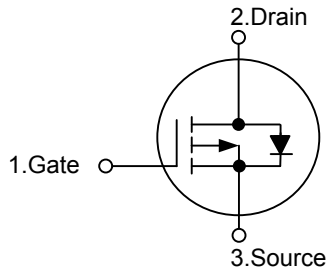

■ ORDERING INFORMATION

Ordering Number		Package	Pin Assignment								Packing
Lead Free	Halogen Free		1	2	3	4	5	6	7	8	
-	UT9435G-AB3-R	SOT-89	G	D	S	-	-	-	-	-	Tape Reel
UT9435L-TN3-R	UT9435G-TN3-R	TO-252	G	D	S	-	-	-	-	-	Tape Reel
-	UT9435G-S08-R	SOP-8	S	S	S	G	D	D	D	D	Tape Reel

Note: Pin Assignment: G: Gate D: Drain S: Source

<p>UT9435G-AB3-R</p> <p>(1)Packing Type</p> <p>(2)Package Type</p> <p>(3)Green Package</p>	<p>(1) R: Tape Reel</p> <p>(2) AB3: SOT-89, TN3: TO-252, SO8: SOP-8</p> <p>(3) G: Halogen Free and Lead Free, L: Lead Free</p>
--	--

■ MARKING

PACKAGE	MARKING
SOT-89	
SOP-8	
TO-252	

■ PIN CONFIGURATION (For SOP-8)

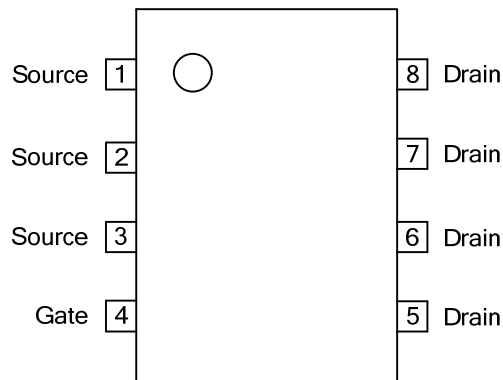

■ ABSOLUTE MAXIMUM RATINGS ( $T_A = 25^\circ\text{C}$ , unless otherwise specified)

PARAMETER		SYMBOL	RATINGS	UNIT
Drain-Source Voltage		$V_{DSS}$	-30	V
Gate-Source Voltage		$V_{GSS}$	$\pm 20$	V
Continuous Drain Current		$I_D$	-4.2	A
Pulsed Drain Current (Note 1, 2)		$I_{DM}$	-20	A
Power Dissipation ( $T_A = 25^\circ\text{C}$ )	SOT-89	$P_D$	1.25	W
	SOP-8		2.5	
Power Dissipation ( $T_C = 25^\circ\text{C}$ )		$P_D$	12.5	W
Junction Temperature		$T_J$	+150	$^\circ\text{C}$
Storage Temperature		$T_{STG}$	-55 ~ +150	$^\circ\text{C}$

Note: Absolute maximum ratings are those values beyond which the device could be permanently damaged. Absolute maximum ratings are stress ratings only and functional device operation is not implied.

■ THERMAL DATA

PARAMETER		SYMBOL	RATINGS	UNIT
Junction to Ambient	SOT-89	$\theta_{JA}$	100	$^\circ\text{C/W}$
	TO-252		110	
	SOP-8		50	

Note: Surface mounted on 1 in<sup>2</sup> copper pad of FR4 board,  $t \leq 10s$ .

■ ELECTRICAL CHARACTERISTICS ( $T_J = 25^\circ\text{C}$ , unless otherwise specified)

PARAMETER	SYMBOL	TEST CONDITIONS	MIN	TYP	MAX	UNIT
<b>OFF CHARACTERISTICS</b>						
Drain-Source Breakdown Voltage	$BV_{DSS}$	$V_{GS} = 0\text{V}, I_D = -250\text{uA}$	-30			V
Drain-Source Leakage Current	$I_{DSS}$	$V_{DS} = -30\text{V}, V_{GS} = 0\text{V}$			-1	$\text{uA}$
Gate-Source Leakage Current	$I_{GSS}$	$V_{GS} = \pm 20\text{V}$			$\pm 100$	nA
Breakdown Voltage Temperature Coefficient	$\Delta BV_{DSS}/\Delta T_J$	Reference to $25^\circ\text{C}, I_D = -1\text{mA}$		-0.1		$\text{V}/^\circ\text{C}$
<b>ON CHARACTERISTICS</b>						
Gate Threshold Voltage	$V_{GS(TH)}$	$V_{DS} = V_{GS}, I_D = -250\text{uA}$	-1		-3	V
Static Drain-Source On-Resistance (Note 2)	$R_{DS(ON)}$	$V_{GS} = -10\text{V}, I_D = -4\text{A}$			50	$\text{m}\Omega$
		$V_{GS} = -4.5\text{V}, I_D = -2\text{A}$			90	$\text{m}\Omega$
<b>DYNAMIC CHARACTERISTICS</b>						
Input Capacitance	$C_{ISS}$	$V_{GS} = 0\text{V}, V_{DS} = -25\text{V}, f = 1.0\text{MHz}$		520	830	pF
Output Capacitance	$C_{OSS}$		180			pF
Reverse Transfer Capacitance	$C_{RSS}$		130			pF
<b>SWITCHING CHARACTERISTICS</b>						
Turn-ON Delay Time (Note 2)	$t_{D(ON)}$	$V_{DS} = -15\text{V}, I_D = -1\text{A}, R_G = 3.3\Omega, V_{GS} = -10\text{V}, R_D = 15\Omega$		10	48	ns
Turn-ON Rise Time	$t_R$		7	40	ns	
Turn-OFF Delay Time	$t_{D(OFF)}$		26	292	ns	
Turn-OFF Fall Time	$t_F$		14	112	ns	
Total Gate Charge (Note 2)	$Q_G$		10	16	nC	
Gate-Source Charge	$Q_{GS}$	$V_{DS} = -25\text{V}, V_{GS} = -4.5\text{V}, I_D = -4\text{A}$		2		nC
Gate-Drain Charge	$Q_{GD}$			6		nC
<b>SOURCE- DRAIN DIODE RATINGS AND CHARACTERISTICS</b>						
Drain-Source Diode Forward Voltage	$V_{SD}$	$I_S = -1\text{A}, V_{GS} = 0\text{V}$			-1.3	V
Reverse Recovery Time	$t_{RR}$	$I_S = -4\text{A}, V_{GS} = 0\text{V}, dI/dt = -100\text{A}/\mu\text{s}$		30		ns
Reverse Recovery Charge	$Q_{RR}$			24		nC

Notes: 1. Pulse width limited by  $T_{J(MAX)}$

2. Pulse width  $\leq 300\mu\text{s}$ , duty cycle  $\leq 2\%$ .

## TYPICAL CHARACTERISTICS

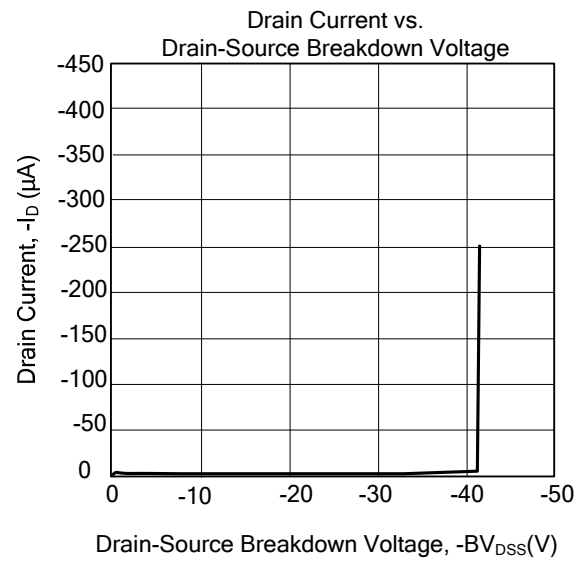
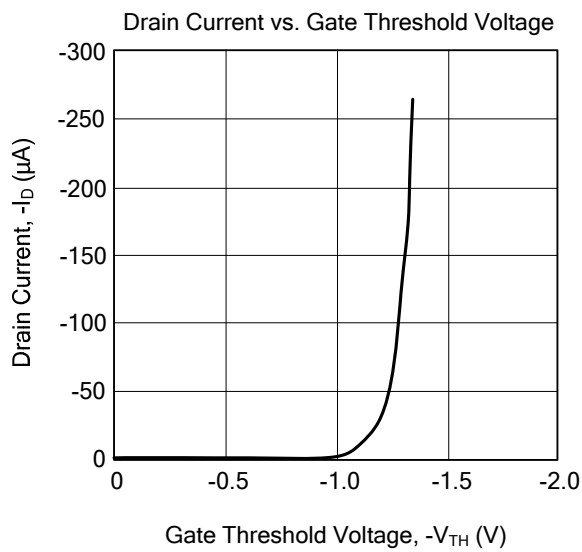
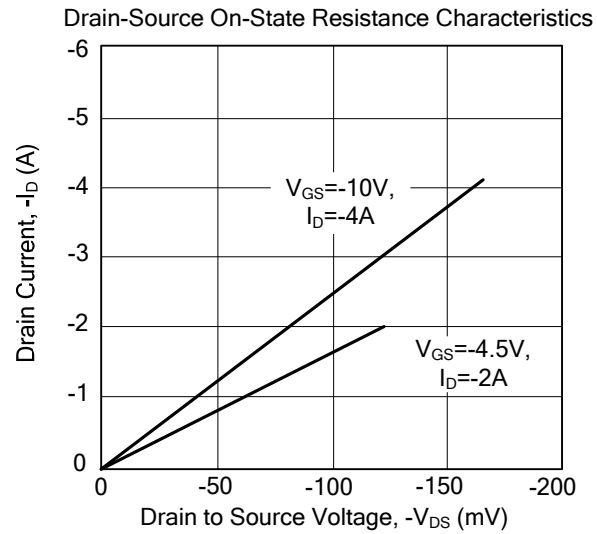
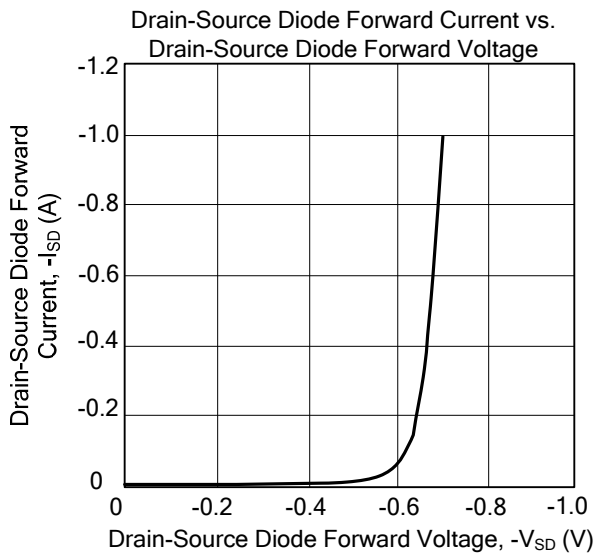

UTC assumes no responsibility for equipment failures that result from using products at values that exceed, even momentarily, rated values (such as maximum ratings, operating condition ranges, or other parameters) listed in products specifications of any and all UTC products described or contained herein. UTC products are not designed for use in life support appliances, devices or systems where malfunction of these products can be reasonably expected to result in personal injury. Reproduction in whole or in part is prohibited without the prior written consent of the copyright owner. The information presented in this document does not form part of any quotation or contract, is believed to be accurate and reliable and may be changed without notice.