



MJE13005-Q

NPN SILICON TRANSISTOR

NPN SILICON POWER TRANSISTORS

■ DESCRIPTION

These devices are designed for high-voltage, high-speed power switching inductive circuits where fall time is critical. They are particularly suited for 115 and 220 V SWITCHMODE.

■ FEATURES

- * $V_{CE0(SUS)} = 400\text{ V}$
- * Reverse bias SOA with inductive loads @ $T_C = 100^\circ\text{C}$
- * Inductive switching matrix 2 to 4 Amp, 25 and 100°C
 $t_c @ 3\text{A}, 100^\circ\text{C}$ is 180 ns (Typ)
- * 700V blocking capability
- * SOA and switching applications information

■ APPLICATIONS

- * Switching regulator's, inverters
- * Motor controls
- * Solenoid/Relay drivers
- * Deflection circuits

■ ORDERING INFORMATION

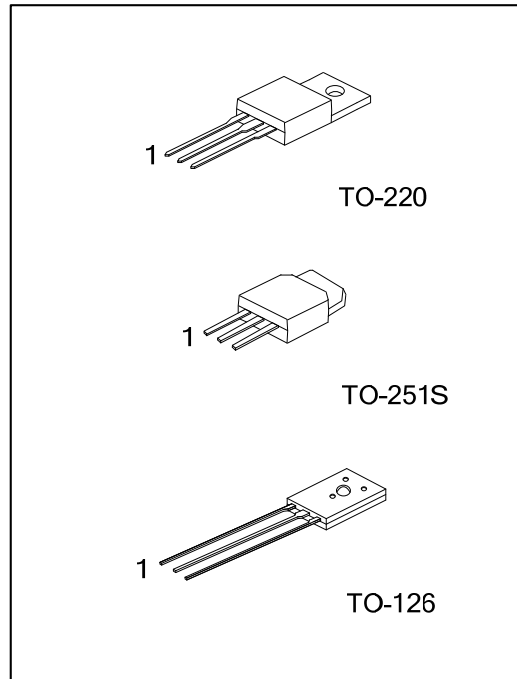

Ordering Number		Package	Pin Assignment			Packing
Lead Free	Halogen Free		1	2	3	
MJE13005L-x-T60-K	MJE13005G-x-T60-K	TO-126	B	C	E	Bulk
MJE13005L-x-TA3-T	MJE13005G-x-TA3-T	TO-220	B	C	E	Tube
MJE13005L-x-TMS-T	MJE13005G-x-TMS-T	TO-251S	B	C	E	Tube

Note: Pin Assignment: B: Base C: Collector E: Emitter

<p>MJE13005L-x-TA3-T</p> <p>(1) Packing Type</p> <p>(2) Package Type</p> <p>(3) Rank</p> <p>(4) Green Package</p>	<p>(1) T: Tube, K: Bulk, R: Tape Reel</p> <p>(2) TA3: TO-220 TMS: TO-251S, T60: TO-126</p> <p>(3) x: refer to Classification of h_{FE1}</p> <p>(4) L: Lead Free, G: Halogen Free and Lead Free</p>
---	---

■ MARKING

TO-220 / TO-251S	TO-126

■ ABSOLUTE MAXIMUM RATINGS

PARAMETER		SYMBOL	RATINGS	UNIT
Collector-Emitter Voltage		$V_{CEO(SUS)}$	400	V
Collector-Emitter Voltage ($V_{BE}=0$)		V_{CES}	700	V
Collector-Base Voltage		V_{CBO}	700	V
Emitter Base Voltage		V_{EBO}	9	V
Collector Current	Continuous	I_C	4	A
	Peak (1)	I_{CM}	8	A
Base Current	Continuous	I_B	2	A
	Peak (1)	I_{BM}	4	A
Emitter Current	Continuous	I_E	6	A
	Peak (1)	I_{EM}	12	A
Power Dissipation at $T_A=25^\circ\text{C}$	TO-126	P_D	40	W
	TO-251S		50	
	TO-220		75	
Derate above 25°C	TO-126		320	mW/ $^\circ\text{C}$
	TO-251S		400	
	TO-220		600	
Operating and Storage Junction Temperature		T_J, T_{STG}	-65 ~ +150	$^\circ\text{C}$

Note: Absolute maximum ratings are those values beyond which the device could be permanently damaged.

Absolute maximum ratings are stress ratings only and functional device operation is not implied.

■ THERMAL DATA

PARAMETER		SYMBOL	RATINGS	UNIT
Junction to Ambient	TO-126	θ_{JA}	89	$^\circ\text{C/W}$
	TO-251S		110	
	TO-220		62.5	
Junction to Case	TO-126	θ_{JC}	3.125	$^\circ\text{C/W}$
	TO-251S		2.5	
	TO-220		1.67	

■ ELECTRICAL CHARACTERISTICS (T_C=25°C, unless otherwise specified)

PARAMETER	SYMBOL	TEST CONDITIONS	MIN	TYP	MAX	UNIT
OFF CHARACTERISTICS (Note 1)						
Collector-Emitter Sustaining Voltage	V _{CEO(SUS)}	I _C =10mA, I _B =0	400			V
Collector Cutoff Current	I _{CBO}	V _{CBO} =Rated Value, V _{BE(OFF)} =1.5V			1	mA
		V _{CBO} =Rated Value, V _{BE(OFF)} =1.5V, T _C =100°C			5	
Emitter Cutoff Current	I _{EBO}	V _{EB} =9V, I _C =0			1	mA
SECOND BREAKDOWN						
Second Breakdown Collector Current with base forward biased	I _{S/B}				See Fig. 11	
Clamped Inductive SOA with Base Reverse Biased	RBSOA				See Fig. 12	
ON CHARACTERISTICS (Note 1)						
DC Current Gain	h _{FE1}	I _C =0.5A, V _{CE} =5V	15		50	
	h _{FE2}	I _C =1A, V _{CE} =5V	10		60	
	h _{FE3}	I _C =2A, V _{CE} =5V	8		40	
Collector-Emitter Saturation Voltage	V _{CE(SAT)}	I _C =1A, I _B =0.2A		0.12	0.5	V
		I _C =2A, I _B =0.5A		0.18	0.6	V
		I _C =4A, I _B =1A		0.7	1	V
		I _C =2A, I _B =0.5A, T _a =100°C			1	V
Base-Emitter Saturation Voltage	V _{BE(SAT)}	I _C =1A, I _B =0.2A		0.85	1.2	V
		I _C =2A, I _B =0.5A		0.92	1.6	V
		I _C =2A, I _B =0.5A, T _C =100°C			1.5	V
DYNAMIC CHARACTERISTICS						
Current-Gain-Bandwidth Product	f _T	I _C =500mA, V _{CE} =10V, f=1MHz	4			MHz
Output Capacitance	C _{OB}	V _{CB} =10V, I _E =0, f=0.1MHz		65		pF
SWITCHING CHARACTERISTICS						
Resistive Load (Table 1)						
Delay Time	t _D	V _{CC} =125V, I _C =2A, I _{B1} =I _{B2} =0.4A, t _p =25μs, Duty Cycle≤1%		0.025	0.1	μs
Rise Time	t _R			0.3	0.7	μs
Storage Time	t _S				6	μs
Fall Time	t _F			0.4	0.9	μs

Note: 1. Pulse Test: Pulse Width=5ms, Duty Cycle≤10%

2. Pulse Test: P_W=300μs, Duty Cycle≤2%

■ CLASSIFICATION OF h_{FE1}

RANK	A	B	C	D	E
RANGE	15 ~ 20	20 ~ 25	25 ~ 30	30 ~ 40	40 ~ 50

APPLICATION INFORMATION

Table 1. Test Conditions for Dynamic Performance

Reverse Bias Safe Operating Area and Inductive Switching		Resistive Switching
Test Circuits	<p>DUTY CYCLE $\leq 10\%$ $t_r, t_f \leq 10\text{ns}$</p> <p>Note: PW and V_{cc} Adjusted for Desired I_c R_B Adjusted for Desired I_{B1}</p>	<p>*SELECTED FOR $\geq 1\text{kV}$</p>
Circuit Values	<p>Coil Data : $V_{CC}=20\text{V}$ FERROXCUBE core #6656 Full Bobbin (~ 16 Turns) #16</p> <p>GAP for 200μH/20 A $L_{\text{COIL}}=200\mu\text{H}$ $V_{\text{CLAMP}}=300\text{V}$</p>	<p>$V_{CC}=125\text{V}$ $R_C=62\Omega$ $D1=1\text{n}5820$ or Equiv. $R_B=22\Omega$</p>
Test Waveforms	<p>OUTPUT WAVEFORMS</p> <p>t_1 Adjusted to Obtain I_c</p> $t_1 = \frac{L_{\text{COIL}}(I_{\text{CPK}})}{V_{\text{CC}}}$ $t_2 = \frac{L_{\text{COIL}}(I_{\text{CPK}})}{V_{\text{CLAMP}}}$ <p>Test Equipment Scope-Tektronics 475 or Equivalent</p>	<p>$t_r, t_f < 10\text{ns}$ Duty Cycle=1.0% R_B and R_C adjusted for desired I_B and I_C</p>

RESISTIVE SWITCHING PERFORMANCE

Fig. 1 Turn-On Time

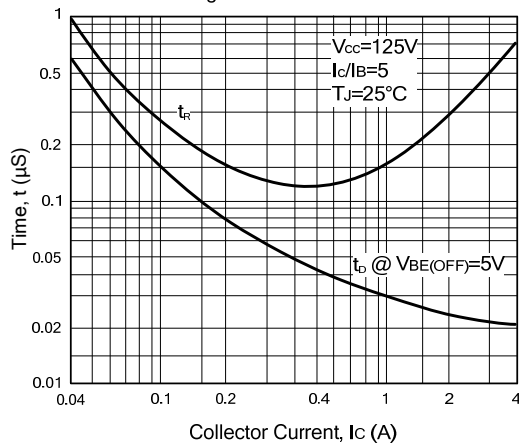

Fig. 2 Turn-Off Time

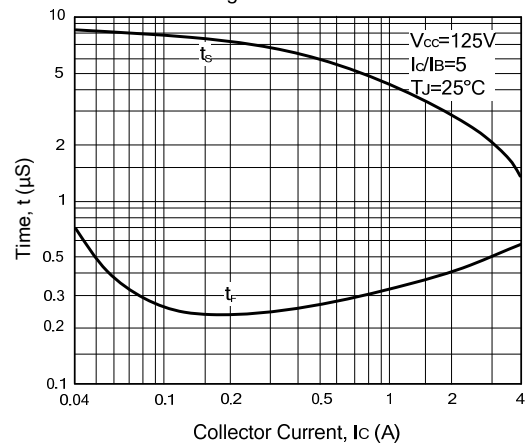

Fig. 3 Typical Thermal Response [$Z_{\theta JC}(t)$]

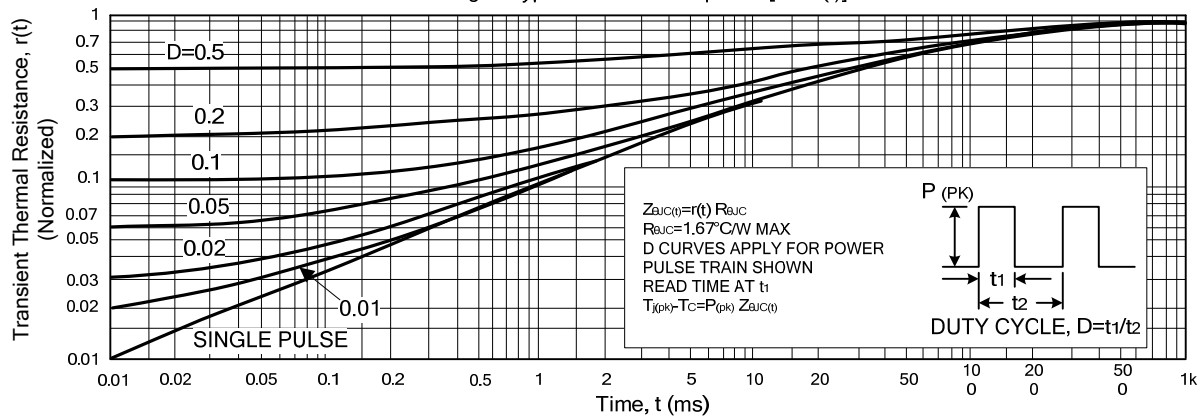

Fig. 4 Forward Bias Safe Operating Area

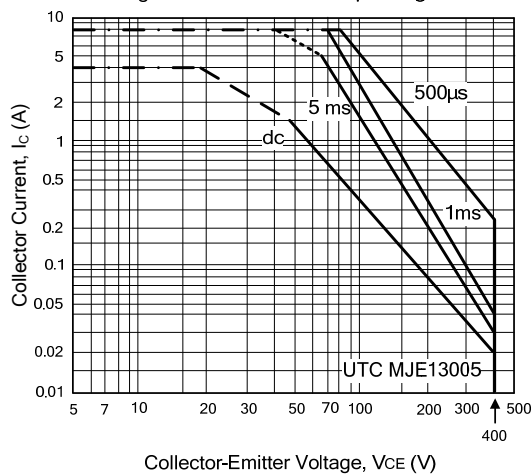
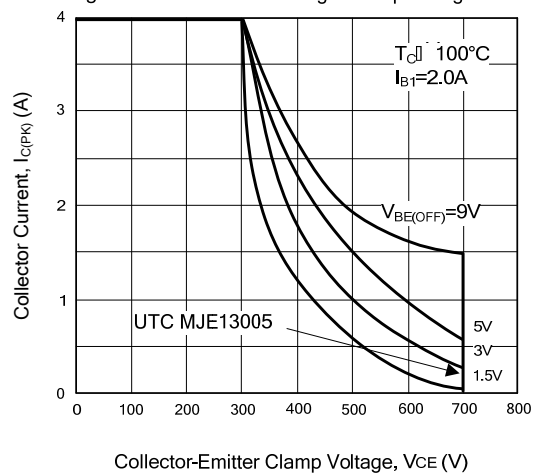
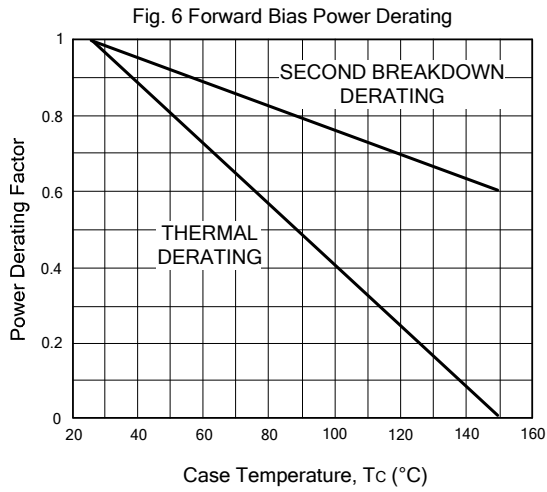

Fig. 5 Reverse Bias Switching Safe Operating Area



■ RESISTIVE SWITCHING PERFORMANCE(Cont.)



UTC assumes no responsibility for equipment failures that result from using products at values that exceed, even momentarily, rated values (such as maximum ratings, operating condition ranges, or other parameters) listed in products specifications of any and all UTC products described or contained herein. UTC products are not designed for use in life support appliances, devices or systems where malfunction of these products can be reasonably expected to result in personal injury. Reproduction in whole or in part is prohibited without the prior written consent of the copyright owner. The information presented in this document does not form part of any quotation or contract, is believed to be accurate and reliable and may be changed without notice.