



UD12K

DUAL TRANSISTOR

GENERAL PURPOSE (DUAL DIGITAL TRANSISTOR)

FEATURES

- * Both the DTA144E chip and DTC144E chip in a SOT-363 package.
- * NPN/PNP silicon transistor(Built-in resistor type)

EQUIVALENT CIRCUIT

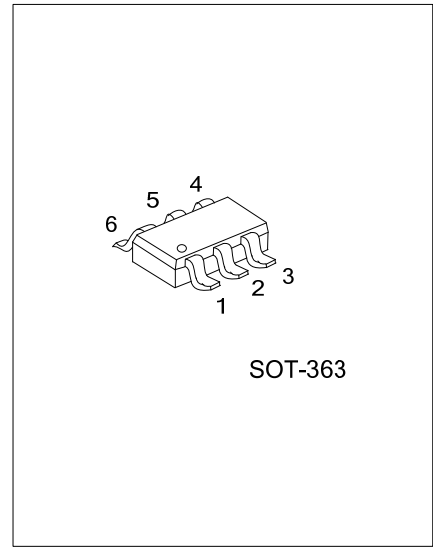
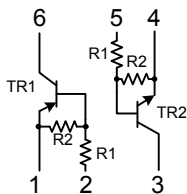

ORDERING INFORMATION

Ordering Number		Package	Pin Assignment						Packing
Lead Free	Halogen-Free		1	2	3	4	5	6	
UD12KL-AL6-R	UD12KG-AL6-R	SOT-363	E1	B1	C2	E2	B2	C1	Tape Reel

<p>UD12KL-AL6-R</p> <p>(1)Packing Type</p> <p>(2)Package Type</p> <p>(3)Lead Free</p>	<p>(1) R: Tape Reel</p> <p>(2) AL6: SOT-363</p> <p>(3) G: Halogen Free, L: Lead Free</p>
---	--

MARKING

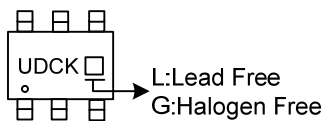

■ ABSOLUTE MAXIMUM RATINGS (Ta=25°C)

TR₁ (PNP)

PARAMETER	SYMBOL	RATINGS	UNIT
Supply Voltage	V _{CC}	-50	V
Input Voltage	V _{IN}	-40~10	V
Output Current	I _C	-100	mA
Total Power Dissipation (120mW per element must not be exceeded)	P _D	150	mW
Junction Temperature	T _J	+150	°C
Storage Temperature	T _{STG}	-55 ~ +150	°C

TR₂ (NPN)

PARAMETER	SYMBOL	RATINGS	UNIT
Supply Voltage	V _{CC}	50	V
Input Voltage	V _{IN}	-10~40	V
Output Current	I _C	100	mA
Total Power Dissipation (120mW per element must not be exceeded)	P _D	150	mW
Junction Temperature	T _J	+150	°C
Storage Temperature	T _{STG}	-55 ~ +150	°C

Note: Absolute maximum ratings are those values beyond which the device could be permanently damaged.

Absolute maximum ratings are stress ratings only and functional device operation is not implied.

■ ELECTRICAL CHARACTERISTICS (Ta=25°C)

TR₁ (PNP)

PARAMETER	SYMBOL	TEST CONDITIONS	MIN	TYP	MAX	UNIT
Input Voltage	V _{I(OFF)}	V _{CC} =-5V, I _{OUT} =-100μA			-0.5	V
	V _{I(ON)}	V _{OUT} =-0.3V, I _{OUT} =-2mA	-3			V
Output Voltage	V _{O(ON)}	I _{OUT} =-10mA, I _{IN} =-0.5mA		-0.1	-0.3	V
Input Current	I _{IN}	V _{IN} =-5V			-0.18	mA
Output Current	I _{O(OFF)}	V _{CC} =-50V, V _{IN} =0V			-0.5	μA
DC Current Gain	h _{FE}	V _{OUT} =-5V, I _{OUT} =-5mA	68			
Collector-Emitter Saturation Voltage	V _{CE(SAT)}	I _C =5mA, I _B =0.25mA		0.1	0.3	V
Transition Frequency	f _T	V _{CE} =-10V, I _E =-5mA, f=100MHz (Note)		250		MHz
Input Resistance	R ₁		32.9	47	61.1	KΩ
Resistance Ratio	R ₂ /R ₁		0.8	1	1.2	

TR₂ (NPN)

PARAMETER	SYMBOL	TEST CONDITIONS	MIN	TYP	MAX	UNIT
Input Voltage	V _{I(OFF)}	V _{CC} =5V, I _{OUT} =100μA			0.5	V
	V _{I(ON)}	V _{OUT} =0.3V, I _{OUT} =2mA	3			V
Output Voltage	V _{O(ON)}	I _{OUT} =10mA, I _{IN} =0.5mA		0.1	0.3	V
Input Current	I _{IN}	V _{IN} =5V			0.18	mA
Output Current	I _{O(OFF)}	V _{CC} =50V, V _{IN} =0V			0.5	μA
DC Current Gain	h _{FE}	V _{OUT} =5V, I _{OUT} =5mA	68			
Collector-Emitter Saturation Voltage	V _{CE(SAT)}	I _C =-5mA, I _B =-0.25mA		-0.1	-0.3	V
Transition Frequency	f _T	V _{CE} =10V, I _E =-5mA, f=100MHz (Note)		250		MHz
Input Resistance	R ₁		32.9	47	61.1	KΩ
Resistance Ratio	R ₂ /R ₁		0.8	1	1.2	

Note: Transition frequency of the device

TYPICAL CHARACTERISTICS

TR₁ (PNP)

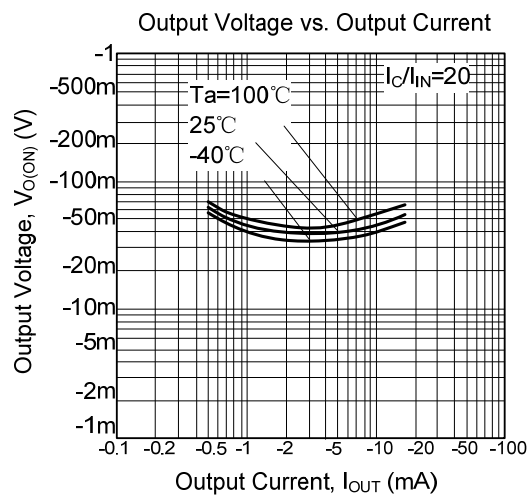
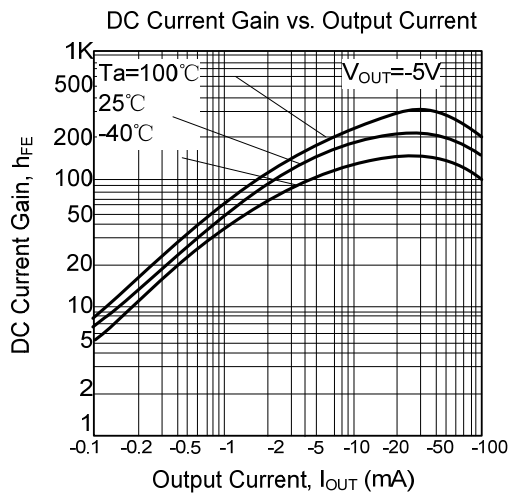
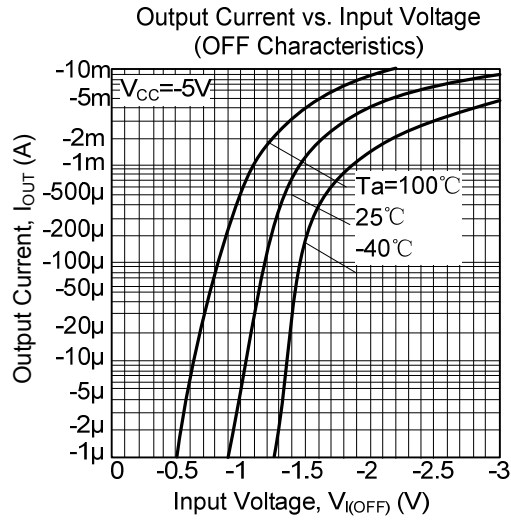
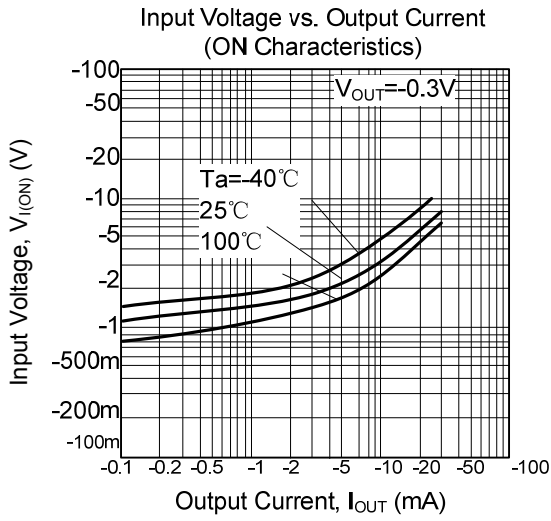

TR₂ (NPN)

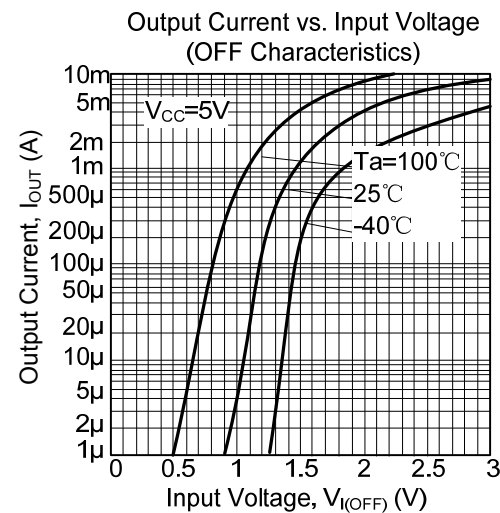
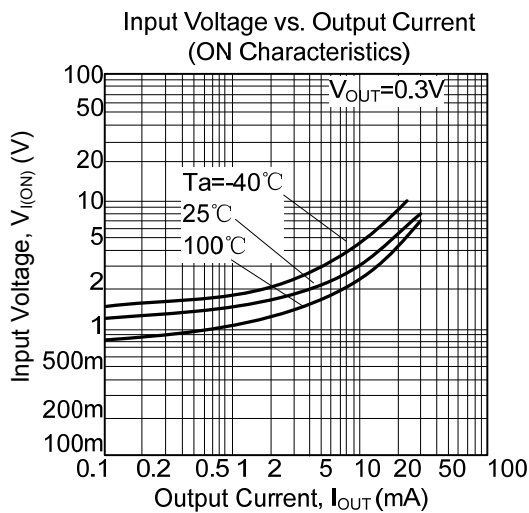

■ TYPICAL CHARACTERISTICS(Cont.)

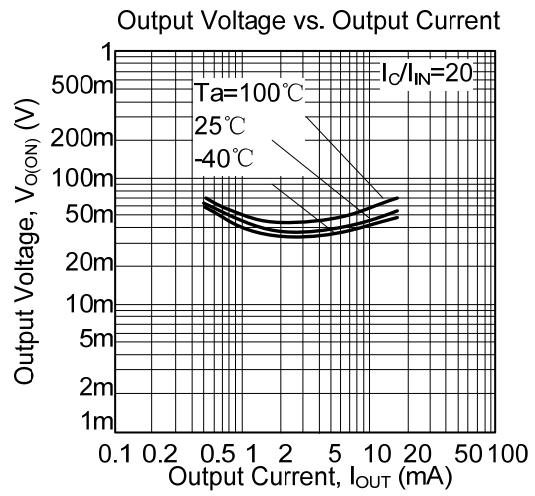
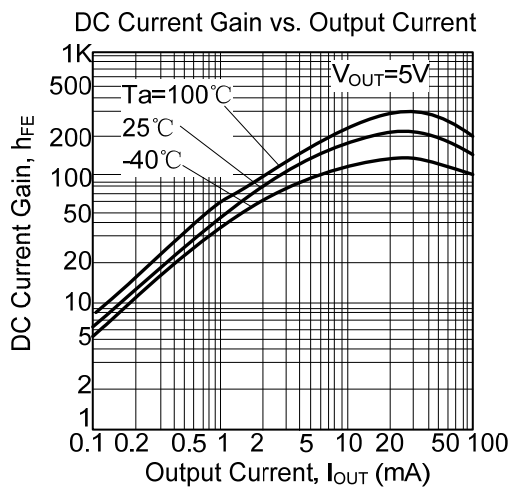

UTC assumes no responsibility for equipment failures that result from using products at values that exceed, even momentarily, rated values (such as maximum ratings, operating condition ranges, or other parameters) listed in products specifications of any and all UTC products described or contained herein. UTC products are not designed for use in life support appliances, devices or systems where malfunction of these products can be reasonably expected to result in personal injury. Reproduction in whole or in part is prohibited without the prior written consent of the copyright owner. The information presented in this document does not form part of any quotation or contract, is believed to be accurate and reliable and may be changed without notice.