



IMT17

DUAL TRANSISTOR

GENERAL PURPOSE DUAL TRANSISTOR

■ FEATURES

- *Two MMBT2907A chips in an SMT package.
- *Transistor elements are independent, eliminating interference.
- *High collector current. $I_c = -500\text{mA}$

■ EQUIVALENT CIRCUITS

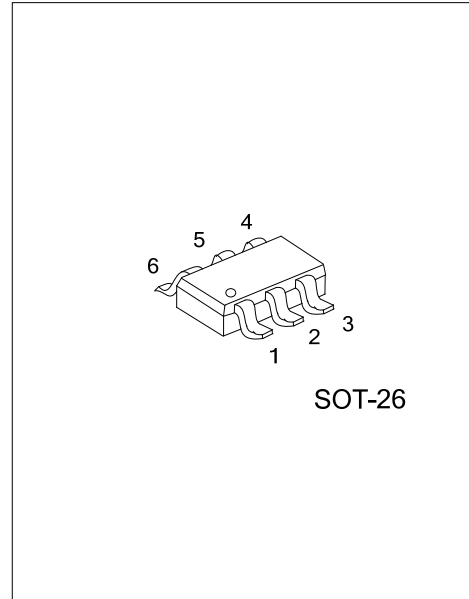
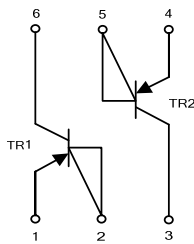

■ ORDERING INFORMATION

Ordering Number		Package	Pin Assignment						Packing
Lead Free	Halogen Free		1	2	3	4	5	6	
IMT17L-AG6-R	IMT17G-AG6-R	SOT-26	E1	B1	C2	E2	B2	C1	Tape Reel

Note: Pin Assignment: B: Base C: Collector E: Emitter

<p>IMT17L-AG6-R</p> <p>(1) Packing Type (2) Package Type (3) Lead Free</p>	<p>(1) R: Tape Reel (2) AG6: SOT-26 (3) G: Halogen Free, L: Lead Free</p>
--	---

■ MARKING

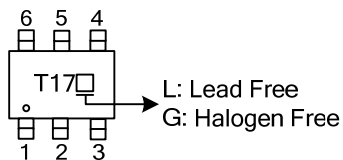

■ ABSOLUTE MAXIMUM RATINGS* (Ta = 25°C)

PARAMETER	SYMBOL	RATINGS	UNIT
Collector Base Voltage	V _{CBO}	-60	V
Collector Emitter Voltage	V _{CEO}	-50	V
Emitter Base Voltage	V _{EBO}	-5	V
Collector Current	I _C	-500	mA
Power Dissipation	P _D	300	mW*
Junction Temperature	T _J	+150	°C
Storage Temperature	T _{STG}	-40 ~ +150	°C

*200mW per element must not be exceeded.

■ ELECTRICAL CHARACTERISTICS (Ta= 25°C, unless otherwise specified.)

PARAMETER	SYMBOL	TEST CONDITIONS	MIN	TYP	MAX	UNIT
Collector Base Breakdown Voltage	BV _{CBO}	I _C = -100μA	-60			V
Collector Emitter Breakdown Voltage	BV _{CEO}	I _C = -1mA	-50			V
Emitter Base Breakdown Voltage	BV _{EBO}	I _E = -100μA	-5			V
Collector Emitter Saturation Voltage	V _{CE(sat)}	I _C = -500mA, I _B = -50mA			-0.6	V
Collector Cutoff Current	I _{CBO}	V _{CB} = -30V			-0.1	μA
Emitter Cutoff Current	I _{EBO}	V _{EB} = -4V			-0.1	μA
Output Capacitance	C _{ob}	V _{CE} = -10V, I _E =0A, f =1MHz		7		pF
DC Current Transfer Ratio	h _{FE}	V _{CE} = -3V, I _C = -100mA	120		390	
Transition Frequency	f _T	V _{CE} = -10V, I _E =20mA, f =100MHz		200		MHz

*Measured using pulse current.

■ TYPICAL CHARACTERISTICS

Grounded Emitter Propagation Characteristics

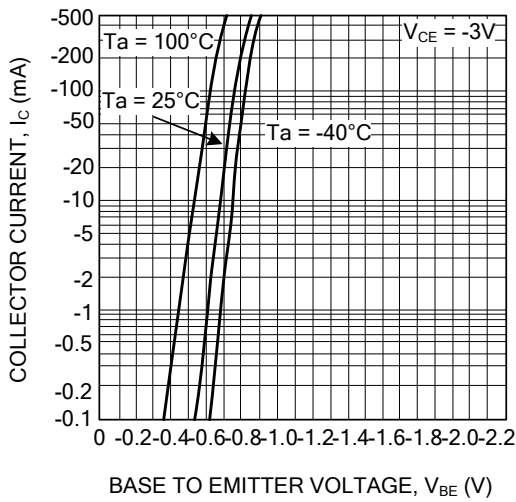

Gain Bandwidth Product vs. Emitter Current

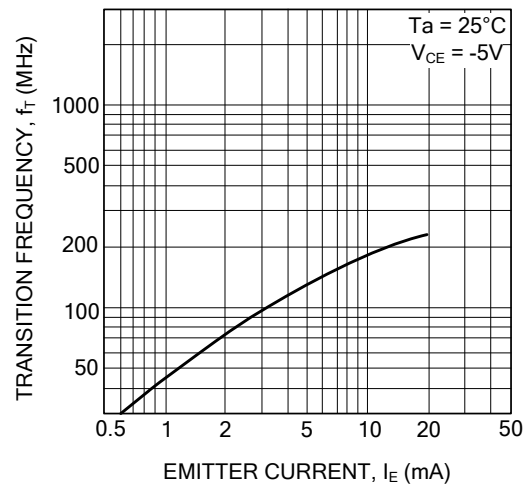

Grounded Emitter Output Characteristics (I)

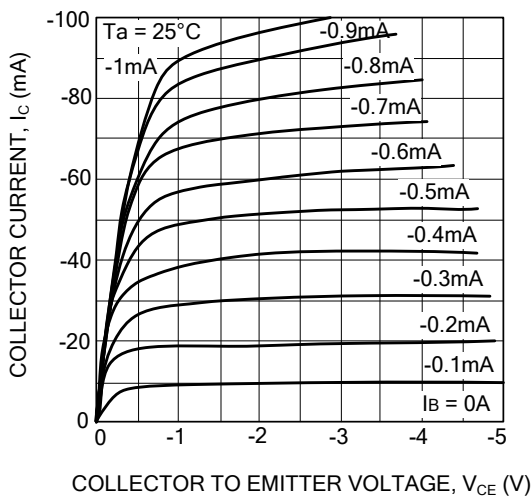

Grounded Emitter Output Characteristics (II)

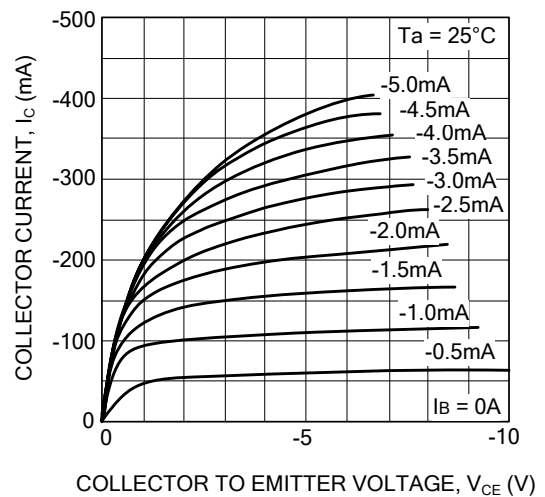

DC Current Gain vs. Collector Current (I)

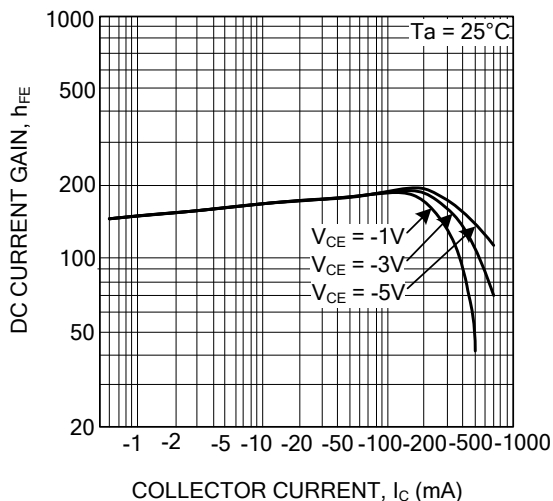

DC Current Gain vs. Collector Current (II)

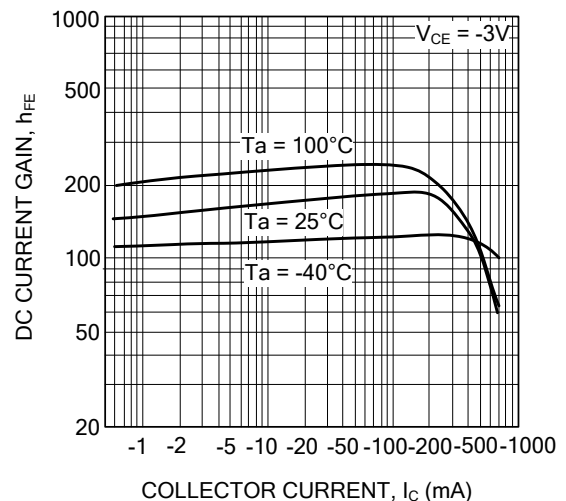

■ TYPICAL CHARACTERISTICS(cont.)

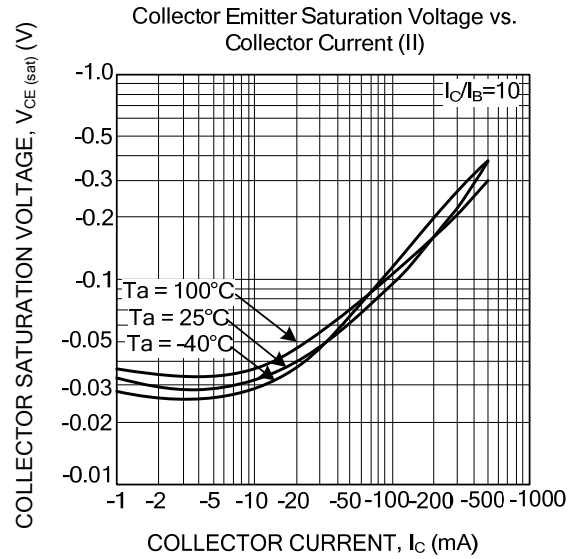
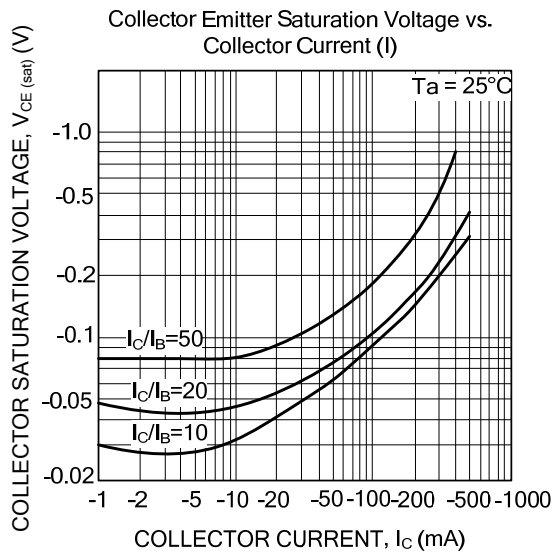

Collector Output Capacitance vs. Collector Base Voltage
Emitter Input Capacitance vs. Emitter Base Voltage

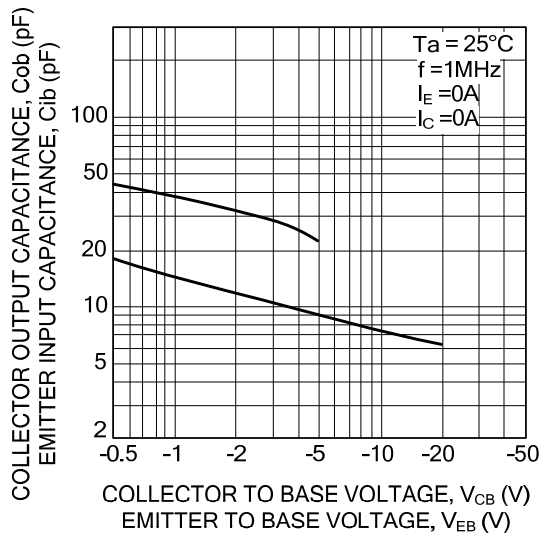

UTC assumes no responsibility for equipment failures that result from using products at values that exceed, even momentarily, rated values (such as maximum ratings, operating condition ranges, or other parameters) listed in products specifications of any and all UTC products described or contained herein. UTC products are not designed for use in life support appliances, devices or systems where malfunction of these products can be reasonably expected to result in personal injury. Reproduction in whole or in part is prohibited without the prior written consent of the copyright owner. The information presented in this document does not form part of any quotation or contract, is believed to be accurate and reliable and may be changed without notice.