



MMBTA42/43

NPN SILICON TRANSISTOR

HIGH VOLTAGE TRANSISTOR

DESCRIPTION

The UTC **MMBTA42/43** are high voltage transistors, designed for telephone switch and high voltage switch.

FEATURES

- * Collector-Emitter voltage: $V_{CE0}=300V$ (MMBTA42)
- * Collector-Emitter voltage: $V_{CE0}=200V$ (MMBTA43)
- * High current gain
- * Collector Dissipation: $P_{C(max)}=350mW$

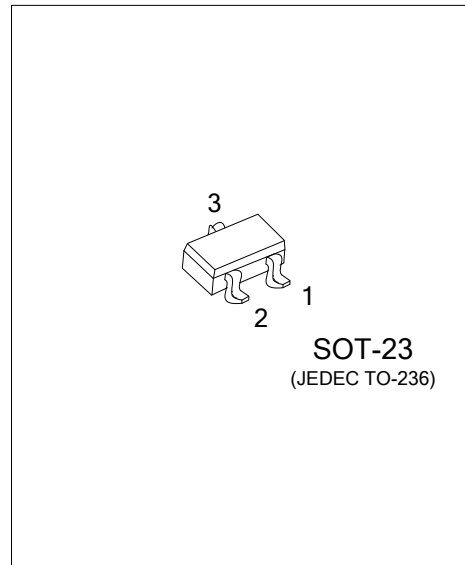

ORDERING INFORMATION

Ordering Number	Package	Pin Assignment			Packing
		1	2	3	
MMBTA42G-AE3-R	SOT-23	E	B	C	Tape Reel
MMBTA43G-AE3-R	SOT-23	E	B	C	Tape Reel

Note: Pin Assignment: E: Emitter B: Base C: Collector

<p>MMBTA42G-AE3-R</p> <p>(1) Packing Type</p> <p>(2) Package Type</p> <p>(3) Green Package</p>	<p>(1) R: Tape Reel</p> <p>(2) AE3: SOT-23</p> <p>(3) G: Halogen Free and Lead Free</p>
------------------------------------------------------------------------------------------------	-----------------------------------------------------------------------------------------

MARKING

MMBTA42	MMBTA43
<p>1DG</p>	<p>1FG</p>

MMBTA42/43

NPN SILICON TRANSISTOR

■ ABSOLUTE MAXIMUM RATINGS ($T_A=25^\circ\text{C}$, unless otherwise specified)

PARAMETER		SYMBOL	RATINGS	UNIT
Collector-Base Voltage	MMBTA42	V_{CBO}	300	V
	MMBTA43		200	
Collector-Emitter Voltage	MMBTA42	V_{CEO}	300	V
	MMBTA43		200	
Emitter-Base Voltage		V_{EBO}	6	V
Collector Dissipation ($T_a=25^\circ\text{C}$)		P_C	350	mW
Collector Current		I_C	500	mA
Junction Temperature		T_J	+150	$^\circ\text{C}$
Storage Temperature		T_{STG}	-55 ~ +150	$^\circ\text{C}$

Note: Absolute maximum ratings are those values beyond which the device could be permanently damaged. Absolute maximum ratings are stress ratings only and functional device operation is not implied

■ ELECTRICAL CHARACTERISTICS ($T_J=25^\circ\text{C}$, unless otherwise specified)

PARAMETER		SYMBOL	TEST CONDITIONS	MIN	TYP	MAX	UNIT
Collector-Base Breakdown Voltage	MMBTA42	BV_{CBO}	$I_C=100\mu\text{A}, I_E=0$	300			V
	MMBTA43			200			
Collector-Emitter Breakdown Voltage	MMBTA42	BV_{CEO}	$I_C=1\text{mA}, I_B=0$	300			V
	MMBTA43			200			
Emitter-Base Breakdown Voltage		BV_{EBO}	$I_E=100\mu\text{A}, I_C=0$	6			V
Collector-Emitter Saturation Voltage		$V_{CE(SAT)}$	$I_C=20\text{mA}, I_B=2\text{mA}$			0.2	V
Base-Emitter Saturation Voltage		$V_{BE(SAT)}$	$I_C=20\text{mA}, I_B=2\text{mA}$			0.90	V
Collector Cut-Off Current	MMBTA42	I_{CBO}	$V_{CB}=200\text{V}, I_E=0$			100	nA
	MMBTA43		$V_{CB}=160\text{V}, I_E=0$			100	
Emitter Cut-Off Current	MMBTA42	I_{EBO}	$V_{EB}=6\text{V}, I_C=0$			100	nA
	MMBTA43		$V_{EB}=4\text{V}, I_C=0$			100	
DC Current Gain			$V_{CE}=10\text{V}, I_C=1\text{mA}$	80			
			$V_{CE}=10\text{V}, I_C=10\text{mA}$	80		300	
			$V_{CE}=10\text{V}, I_C=30\text{mA}$	80			
Current Gain Bandwidth Product		f_T	$V_{CE}=20\text{V}, I_C=10\text{mA}$ $f=100\text{MHz}$	50			MHz
Collector Base Capacitance	MMBTA42	C_{cb}	$V_{CB}=20\text{V}, I_E=0, f=1\text{MHz}$			3	pF
	MMBTA43					4	

TYPICAL CHARACTERISTICS

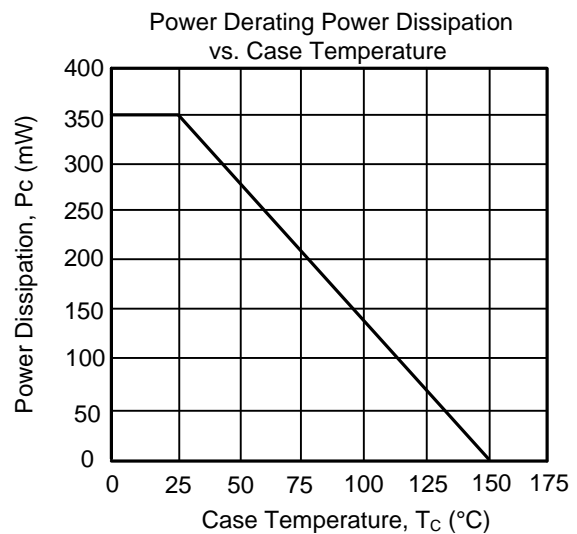
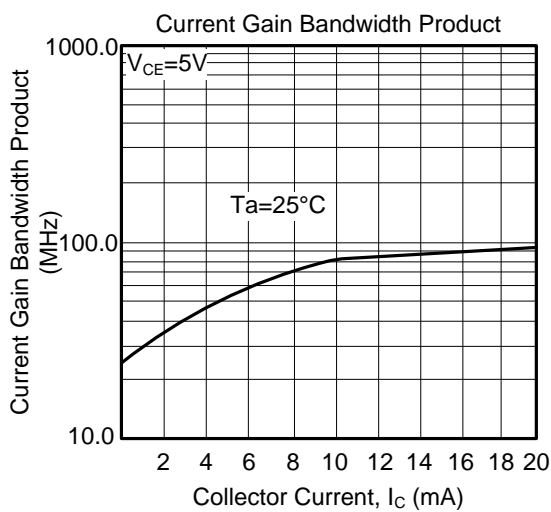
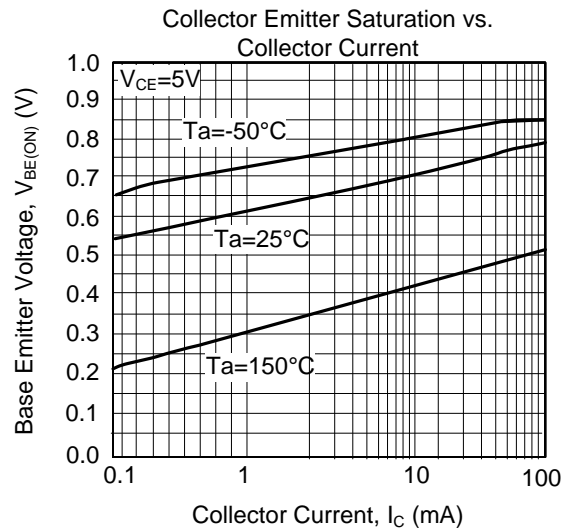
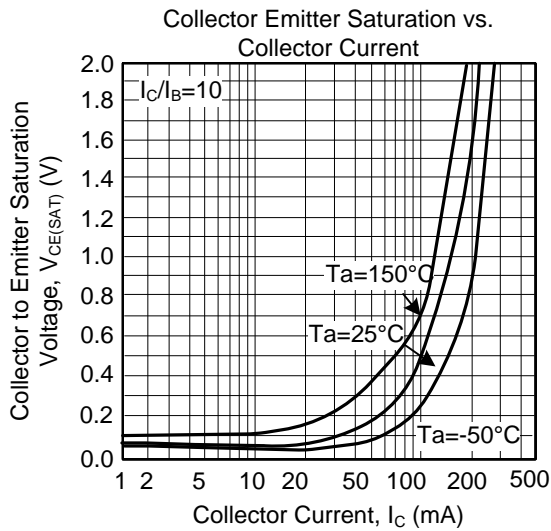
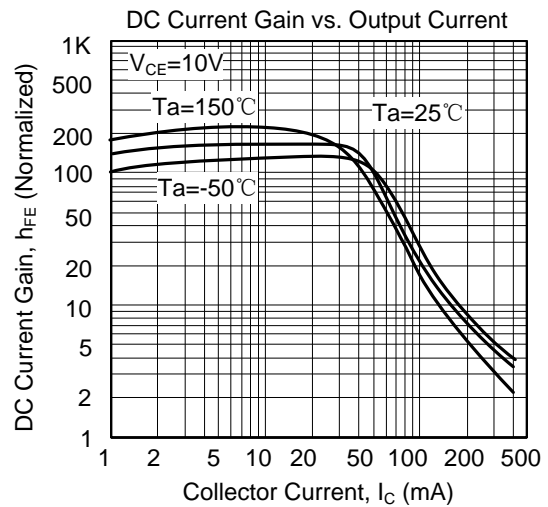
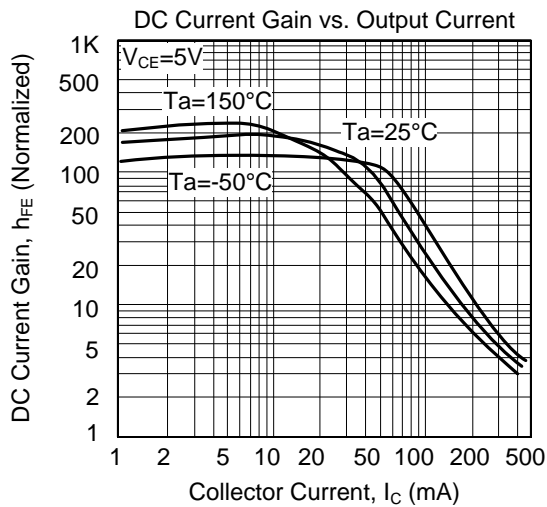

UTC assumes no responsibility for equipment failures that result from using products at values that exceed, even momentarily, rated values (such as maximum ratings, operating condition ranges, or other parameters) listed in products specifications of any and all UTC products described or contained herein. UTC products are not designed for use in life support appliances, devices or systems where malfunction of these products can be reasonably expected to result in personal injury. Reproduction in whole or in part is prohibited without the prior written consent of the copyright owner. The information presented in this document does not form part of any quotation or contract, is believed to be accurate and reliable and may be changed without notice.