



2SC3834

NPN SILICON TRANSISTOR

SWITCH NPN TRANSISTOR

DESCRIPTION

The UTC **2SC3834** is an epitaxial planar type NPN silicon transistor.

FEATURES

* Humidifier, DC-DC converter, and general purpose

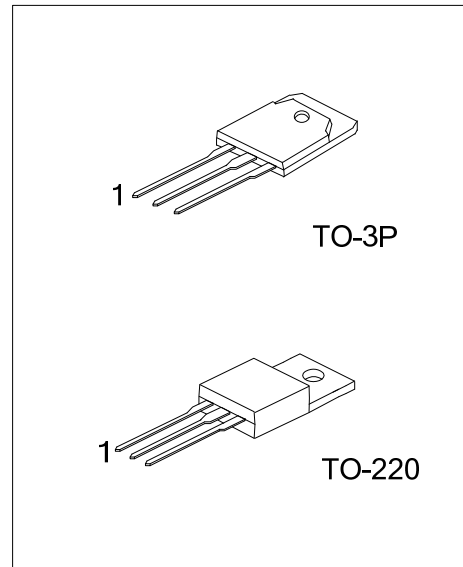

ORDERING INFORMATION

Ordering Number		Package	Pin Assignment			Packing
Lead Free Plating	Halogen Free		1	2	3	
2SC3834L-TA3-T	2SC3834G-TA3-T	TO-220	B	C	E	Tube
2SC3834L-T3P-T	2SC3834G-T3P-T	TO-3P	B	C	E	Tube

Note: Pin Assignment: B: Base C: Collector E: Emitter

<p>2SC3834L-TA3-T</p> <p>(1) Packing Type (2) Package Type (3) Green Package</p>	<p>(1) T: Tube (2) TA3: TO-220 (3) L: Lead Free, G: Halogen Free and Lead Free</p>
--	--

MARKING

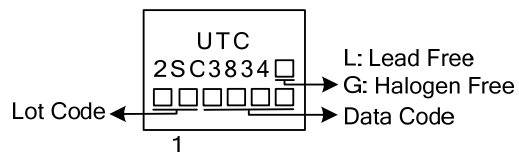

■ ABSOLUTE MAXIMUM RATING ($T_A=25^\circ\text{C}$, unless otherwise specified)

PARAMETER	SYMBOL	RATINGS	UNIT
Collector-Base Voltage	V_{CB0}	200	V
Collector-emitter voltage	V_{CEO}	120	V
Emitter-Base Voltage	V_{EBO}	8	V
Collector Current (Pulse)	I_C	7	A
Base Current	I_B	3	A
Collector Dissipation ($T_C=25^\circ\text{C}$)	P_C	50	W
Junction Temperature	T_J	+150	$^\circ\text{C}$
Storage Temperature	T_{STG}	-55 ~ +150	$^\circ\text{C}$

Note: Absolute maximum ratings are those values beyond which the device could be permanently damaged. Absolute maximum ratings are stress ratings only and functional device operation is not implied.

■ ELECTRICAL CHARACTERISTICS ($T_A=25^\circ\text{C}$, unless otherwise specified)

PARAMETER	SYMBOL	TEST CONDITIONS	MIN	TYP	MAX	UNIT
Collector-Emitter Breakdown Voltage	BV_{CEO}	$I_C=50\text{mA}$	120			V
Collector Cutoff Current	I_{CB0}	$V_{CB}=200\text{V}, I_E=0\text{A}$			100	μA
Emitter Cutoff Current	I_{EBO}	$V_{EB}=8\text{V}, I_C=0\text{A}$			100	μA
DC Current Gain (Note)	h_{FE}	$V_{CE}=4\text{V}, I_C=3\text{A}$	70		220	
Collector-Emitter Saturation Voltage	$V_{CE(SAT)}$	$I_C=3\text{A}, I_B=0.3\text{A}$			0.5	V
Base-Emitter Saturation Voltage	$V_{BE(SAT)}$	$I_C=3\text{A}, I_B=0.3\text{A}$			1.2	V
Current Gain Bandwidth Product	f_T	$I_E=-0.5\text{mA}, V_{CE}=12\text{V}, f=100\text{MHz}$		30		MHz
Output Capacitance	C	$V_{CB}=10\text{V}, I_E=0\text{A}, f=1\text{MHz}$		110		pF

TYPICAL CHARACTERISTICS

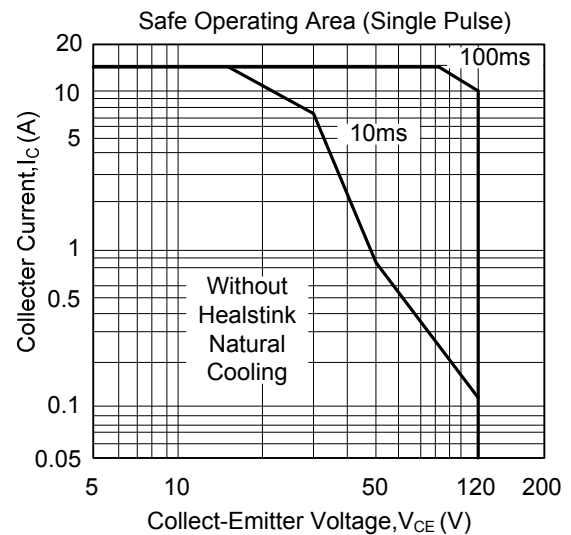
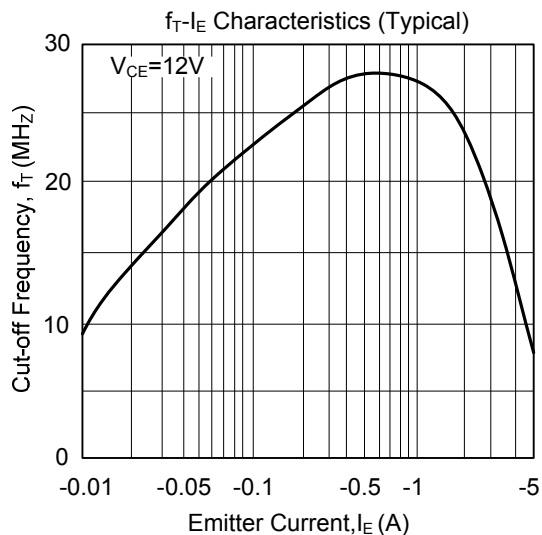
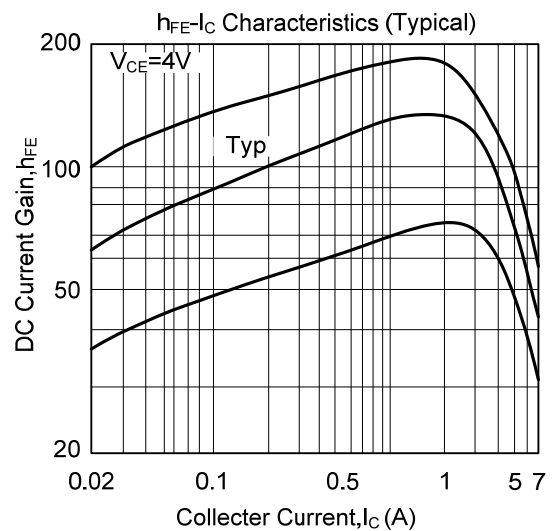
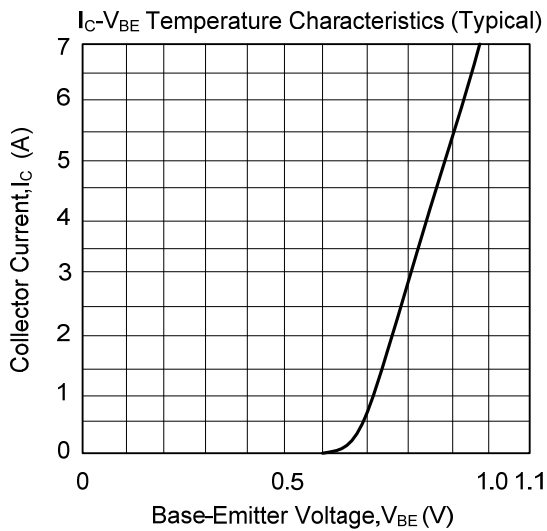
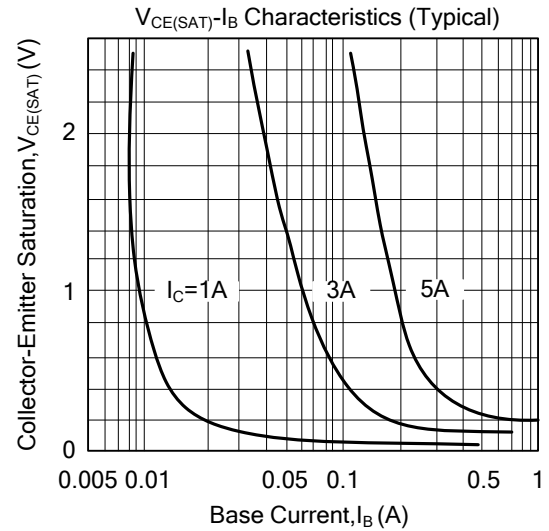
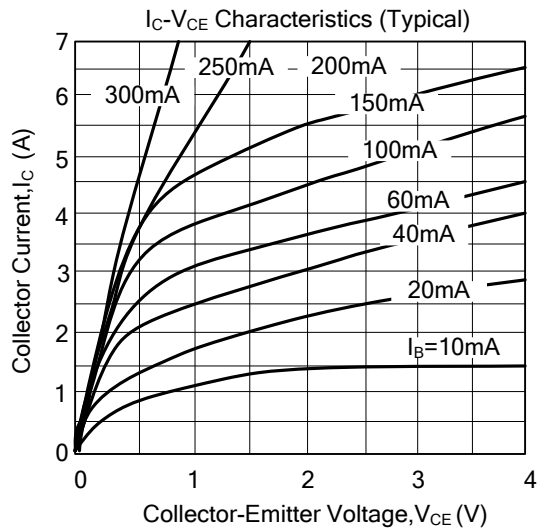

■ TYPICAL CHARACTERISTICS(Cont.)

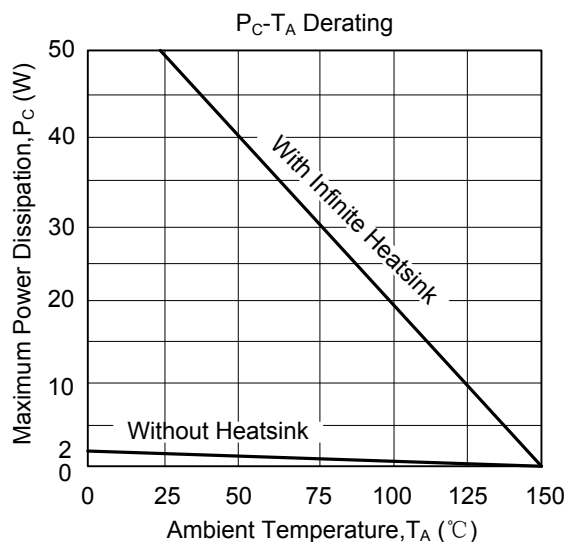
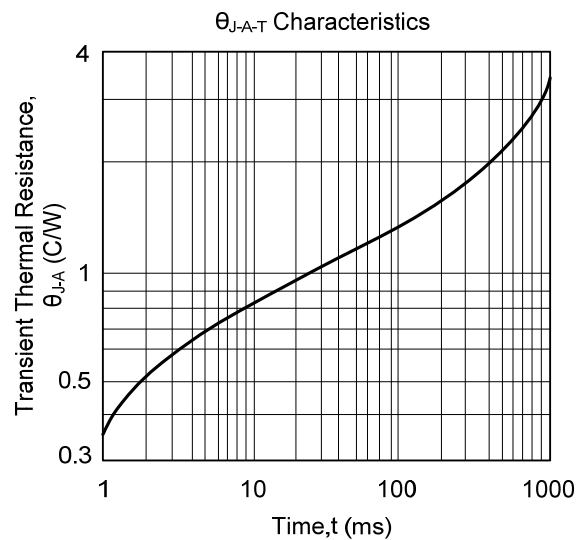
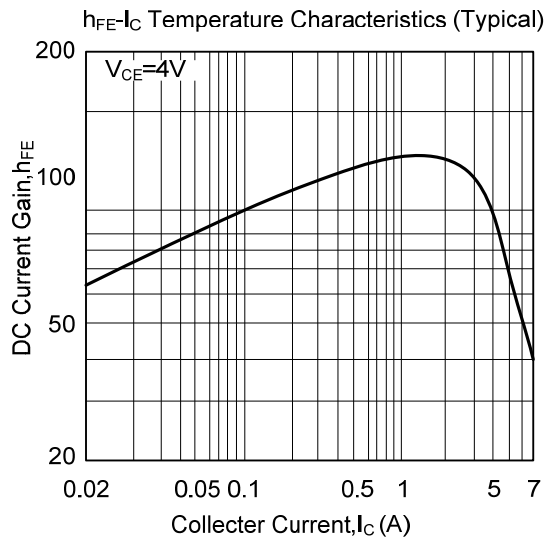

UTC assumes no responsibility for equipment failures that result from using products at values that exceed, even momentarily, rated values (such as maximum ratings, operating condition ranges, or other parameters) listed in products specifications of any and all UTC products described or contained herein. UTC products are not designed for use in life support appliances, devices or systems where malfunction of these products can be reasonably expected to result in personal injury. Reproduction in whole or in part is prohibited without the prior written consent of the copyright owner. The information presented in this document does not form part of any quotation or contract, is believed to be accurate and reliable and may be changed without notice.