



MPSA06

NPN SILICON TRANSISTOR

NPN TRANSISTOR

■ FEATURES

- * Collector-emitter voltage: $V_{CE0}=80V$
- * Collector dissipation: $P_D=625mW$

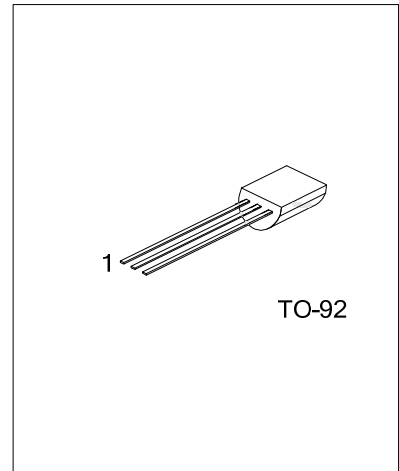

■ ORDERING INFORMATION

Ordering Number		Package	Pin Assignment			Packing
Lead Free	Halogen Free		1	2	3	
MPSA06L-T92-B	MPSA06G-T92-B	TO-92	E	B	C	Tape Box
MPSA06L-T92-K	MPSA06G-T92-K	TO-92	E	B	C	Bulk

<p>MPSA06L-T92-B</p> <ul style="list-style-type: none"> (1) Packing Type (2) Package Type (3) Green Package 	<ul style="list-style-type: none"> (1) B: Tape Box, K: Bulk (2) T92: TO-92 (3) L: Lead Free, G: Halogen Free and Lead Free
--	---

■ MARKING

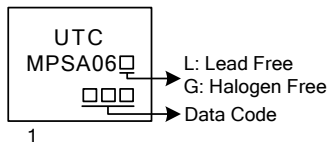

■ ABSOLUTE MAXIMUM RATING ($T_A=25^{\circ}\text{C}$, unless otherwise specified)

PARAMETER	SYMBOL	RATINGS	UNIT
Collector-Base Voltage	V_{CBO}	80	V
Collector-Emitter Voltage	V_{CEO}	80	V
Emitter-Base Voltage	V_{EBO}	4	V
Collector Current - Continuous	I_C	500	mA
Total device Dissipation, @ $T_A=25^{\circ}\text{C}$ Derate above 25°C	P_D	625 5	mW mW/ $^{\circ}\text{C}$
Total device Dissipation, @ $T_C=25^{\circ}\text{C}$ Derate above 25°C	P_D	1500 12	mW mW/ $^{\circ}\text{C}$
Junction Temperature	T_J	+125	$^{\circ}\text{C}$
Storage Temperature	T_{STG}	-55 ~ +150	$^{\circ}\text{C}$

Note: Absolute maximum ratings are those values beyond which the device could be permanently damaged. Absolute maximum ratings are stress ratings only and functional device operation is not implied.

■ THERMAL CHARACTERISTICS

PARAMETER	SYMBOL	RATINGS	UNIT
Junction-to-Ambient	θ_{JA}	200	$^{\circ}\text{C}/\text{W}$
Junction-to-Case	θ_{JC}	83.3	$^{\circ}\text{C}/\text{W}$

■ ELECTRICAL CHARACTERISTICS ($T_a=25^{\circ}\text{C}$, unless otherwise specified)

PARAMETER	SYMBOL	TEST CONDITIONS	MIN	TYP	MAX	UNIT
OFF CHARACTERISTICS						
Collector-Emitter Breakdown Voltage (Note 1)	BV_{CEO}	$I_C=1.0\text{mA}$, $I_B=0$	80			V
Emitter-Base Breakdown Voltage	BV_{EBO}	$I_E=100\mu\text{A}$, $I_C=0$	4			V
Collector Cutoff Current	I_{CEO}	$V_{CE}=60\text{V}$, $I_B=0$			0.1	μA
Collector Cutoff Current	I_{CBO}	$V_{CB}=80\text{V}$, $I_E=0$			0.1	μA
ON CHARACTERISTICS						
Dc Current Gain	h_{FE}	$I_C=10\text{mA}$, $V_{CE}=1\text{V}$	100			
		$I_C=100\text{mA}$, $V_{CE}=1\text{V}$	100			
Collector-Emitter Saturation Voltage	$V_{CE(SAT)}$	$I_C=100\text{mA}$, $I_B=10\text{mA}$			0.25	V
Base-Emitter On Voltage	$V_{BE(ON)}$	$I_C=100\text{mA}$, $V_{CE}=1\text{V}$			1.2	V
SMALL-SIGNAL CHARACTERISTICS						
Current Gain Bandwidth Product (Note 2)	f_T	$I_C=10\text{mA}$, $V_{CE}=2\text{V}$, $f=100\text{MHz}$	100			MHz

Notes: 1. Pulse test: $P_w \leq 300\mu\text{s}$, Duty Cycle $\leq 2\%$.

2. f_T is defined as the frequency at which $|h_{fe}|$ extrapolates to unity.

TYPICAL CHARACTERISTICS

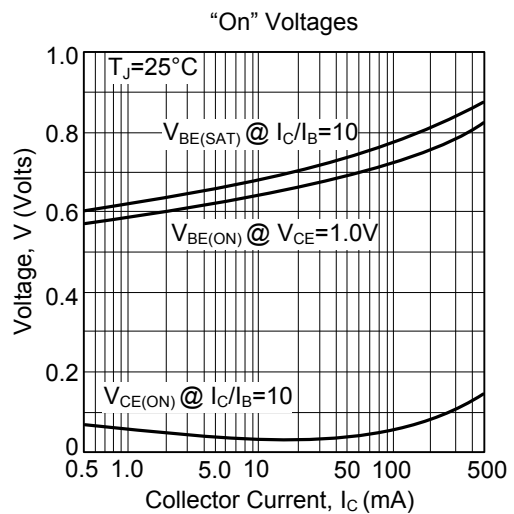
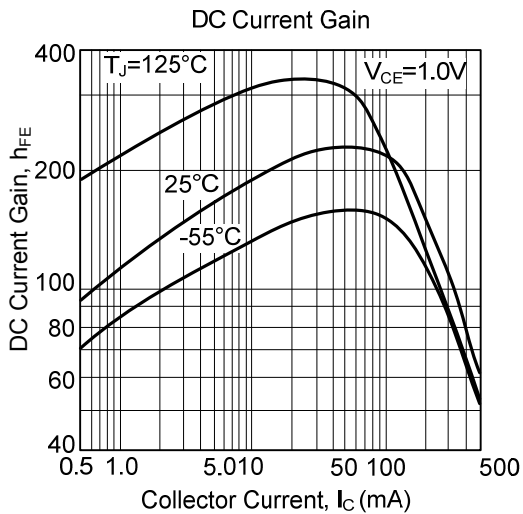
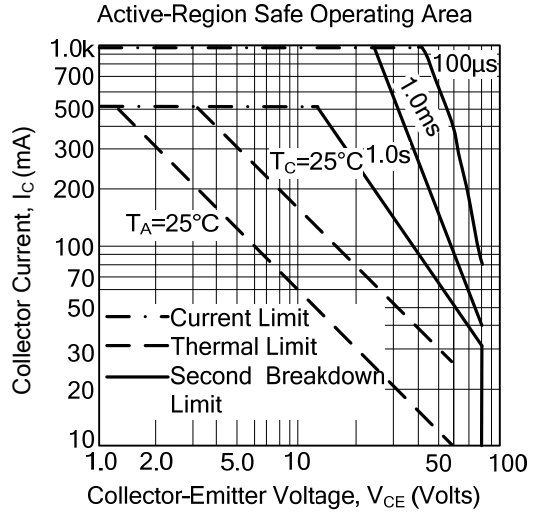
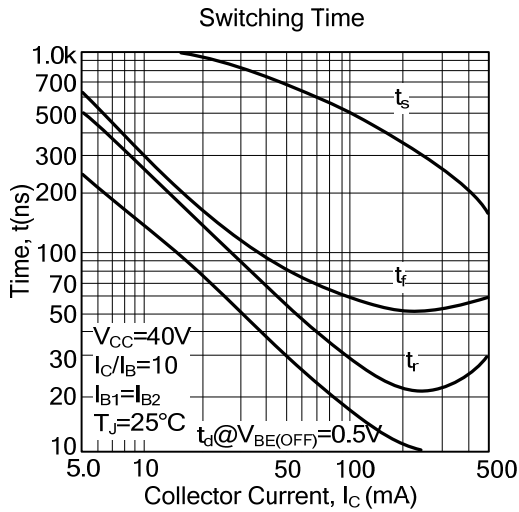
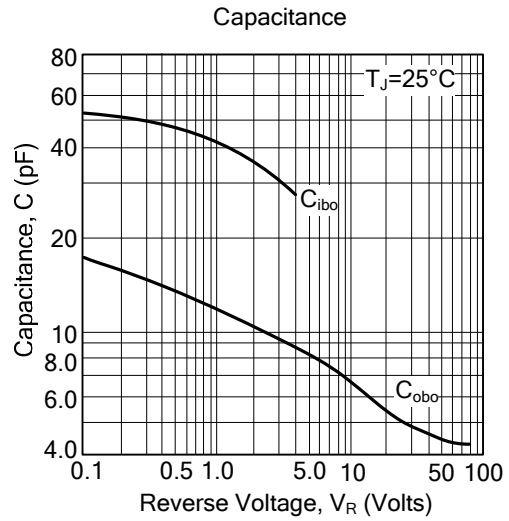
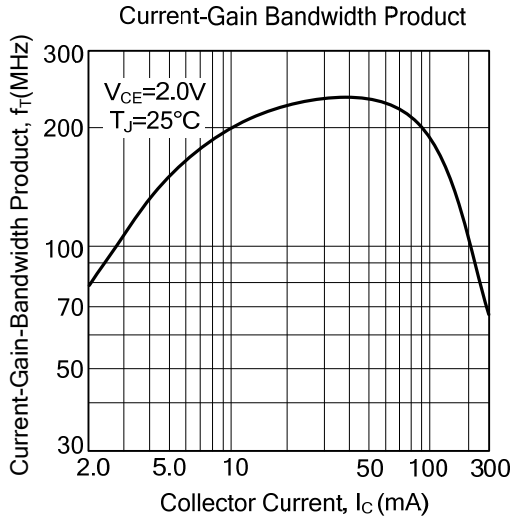

■ TYPICAL CHARACTERISTICS(Cont.)

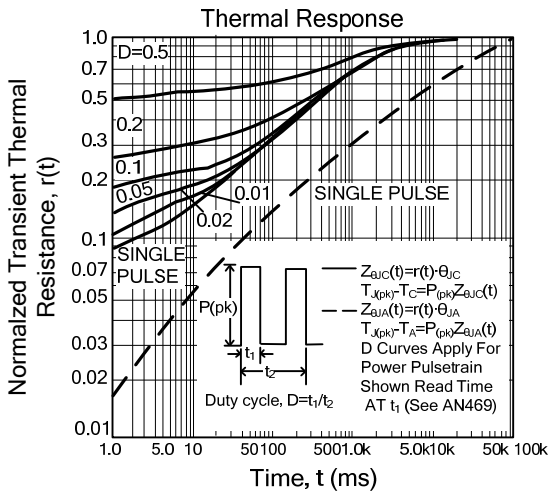
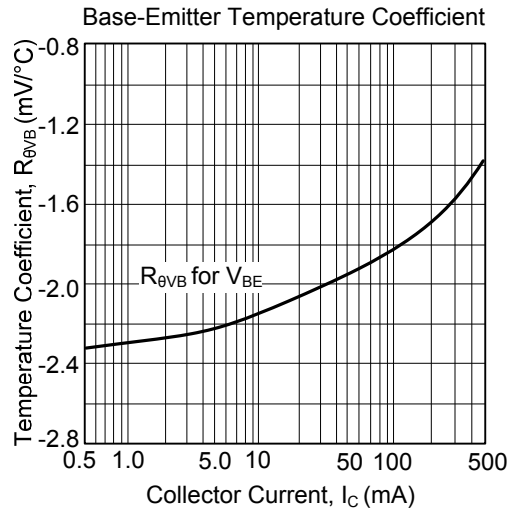
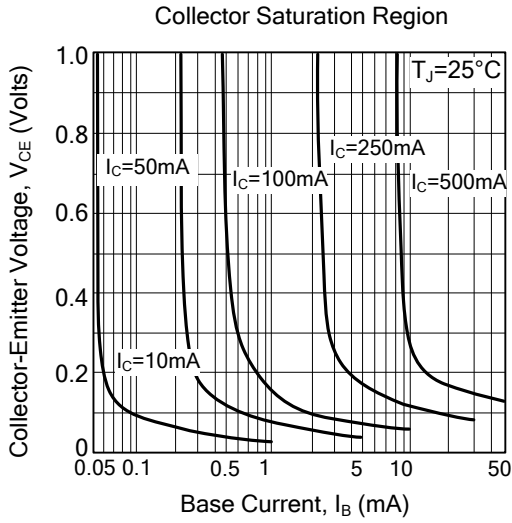

UTC assumes no responsibility for equipment failures that result from using products at values that exceed, even momentarily, rated values (such as maximum ratings, operating condition ranges, or other parameters) listed in products specifications of any and all UTC products described or contained herein. UTC products are not designed for use in life support appliances, devices or systems where malfunction of these products can be reasonably expected to result in personal injury. Reproduction in whole or in part is prohibited without the prior written consent of the copyright owner. The information presented in this document does not form part of any quotation or contract, is believed to be accurate and reliable and may be changed without notice.