



2SB1116/A

PNP SILICON TRANSISTOR

PNP EPITAXIAL SILICON TRANSISTOR

■ DESCRIPTION

Complement to UTC **2SD1616/A**

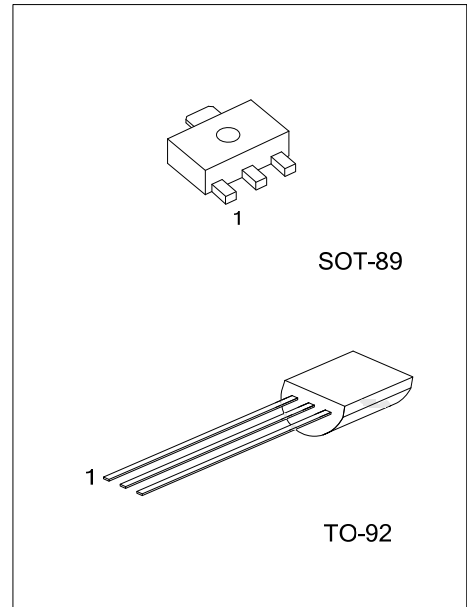

■ ORDERING INFORMATION

Ordering Number		Package	Pin Assignment			Packing
Lead Free	Halogen Free		1	2	3	
-	2SB1116G-x-AB3-B	SOT-89	B	C	E	Tape Reel
2SB1116L-x-T92-B	2SB1116G-x-T92-B	TO-92	E	C	B	Tape Box
2SB1116L-x-T92-K	2SB1116G-x-T92-K	TO-92	E	C	B	Bulk
-	2SB1116AG-x-AB3-B	SOT-89	B	C	E	Tape Reel
2SB1116AL-x-T92-B	2SB1116AG-x-T92-B	TO-92	E	C	B	Tape Box
2SB1116AL-x-T92-K	2SB1116AG-x-T92-K	TO-92	E	C	B	Bulk

Note: Pin Assignment: B: Base C: Collector E: Emitter

<p>2SB1116G-x-AB3-R</p>	<p>(1) R: Tape Reel, B: Tape Box, K: Bulk (2) AB3: SOT-89, T92: TO-92 (3) x: refer to Classification of h_{FE1} (4) L: Lead Free, G: Halogen Free and Lead Free</p>
-------------------------	---

■ MARKING

Package	2SB1116	2SB1116A
SOT-89		
TO-92		

2SB1116/A

PNP SILICON TRANSISTOR

■ ABSOLUTE MAXIMUM RATINGS ($T_A=25^\circ\text{C}$, unless otherwise specified)

PARAMETER		SYMBOL	RATINGS	UNIT
Collector to Base Voltage	2SB1116	V_{CBO}	-60	V
	2SB1116A		-80	
Collector to Emitter Voltage	2SB1116	V_{CEO}	-50	V
	2SB1116A		-60	
Emitter to Base Voltage		V_{EBO}	-6	V
Collector Current	DC	I_C	-1	A
	Pulse(Note2)	I_{CM}	-2	A
Total Power Dissipation	SOT-89	P_C	500	mW
	TO-92		750	mW
Junction Temperature		T_J	+150	$^\circ\text{C}$
Operating Temperature		T_{OPR}	-20 ~ +85	$^\circ\text{C}$
Storage Temperature		T_{STG}	-55 ~ +150	$^\circ\text{C}$

Notes: 1. Absolute maximum ratings are those values beyond which the device could be permanently damaged.

Absolute maximum ratings are stress ratings only and functional device operation is not implied.

2. Pulse width $\leq 10\text{ms}$, Duty cycle $\leq 50\%$

■ ELECTRICAL CHARACTERISTICS ($T_A=25^\circ\text{C}$, unless otherwise specified)

PARAMETER	SYMBOL	TEST CONDITIONS	MIN	TYP	MAX	UNIT
Collector-Emitter Saturation Voltage(Note)	$V_{CE(SAT)}$	$I_C=-1\text{A}, I_B=-50\text{mA}$		-0.2		V
Base-Emitter Saturation Voltage(Note)	$V_{BE(SAT)}$	$I_C=-1\text{A}, I_B=-50\text{mA}$		-0.9	-1.2	V
Base Emitter On Voltage(Note)	$V_{BE(ON)}$	$V_{CE}=-2\text{V}, I_C=-50\text{mA}$	-600	-650	-700	mV
Collector Cut-Off Current	I_{CBO}	$V_{CB}=-60\text{V}, I_E=0$			-100	nA
Emitter Cut-Off Current	I_{EBO}	$V_{EB}=-6\text{V}, I_C=0$			-100	nA
DC Current Gain(Note)	h_{FE1}	$V_{CE}=-2\text{V}, I_C=-100\text{mA}$	2SB1116	135	600	
			2SB1116A	135	400	
	h_{FE2}	$V_{CE}=-2\text{V}, I_C=-1\text{A}$	81			
Transition Frequency	f_T	$V_{CE}=-2\text{V}, I_C=-100\text{mA}$	70	120		MHz
Output Capacitance	C_{OB}	$V_{CB}=-10\text{V}, I_E=0, f=1\text{MHz}$		25		pF
Turn On Time	t_{ON}	$V_{CC}=-10\text{V}, I_C=-100\text{mA}$ $I_{B1}=-I_{B2}=-10\text{mA}, V_{BE(OFF)}=2 \sim 3\text{V}$		0.07		μs
Storage Time	t_{STG}			0.7		μs
Fall Time	t_F			0.07		μs

Note: Pulse Test: Pulse width $\leq 350\mu\text{s}$, Duty cycle $\leq 2\%$.

■ CLASSIFICATION OF h_{FE1}

RANK	Y	G	L
h_{FE1}	135 ~ 270	200 ~ 400	300 ~ 600

TYPICAL CHARACTERISTICS

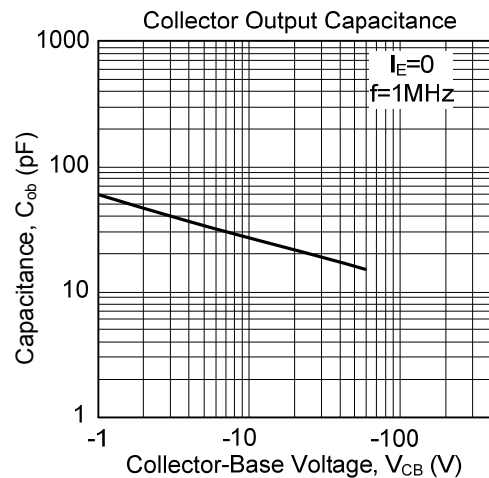
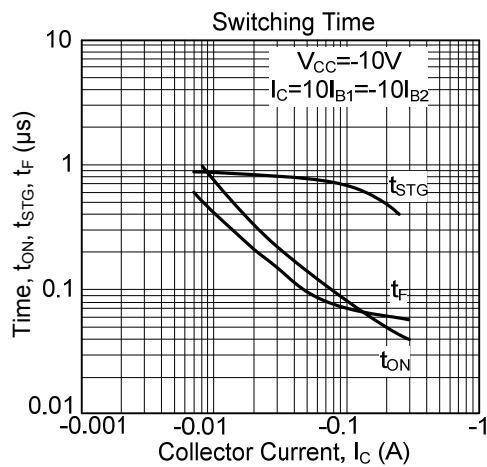
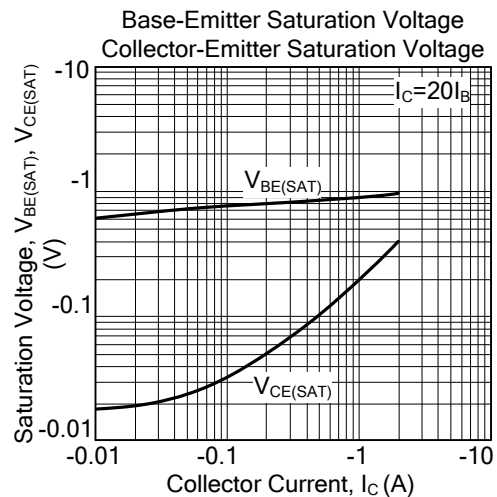
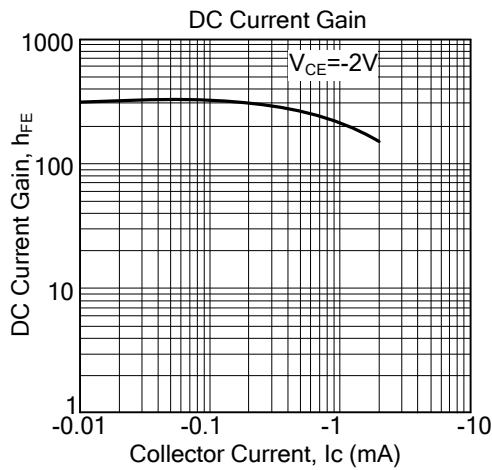
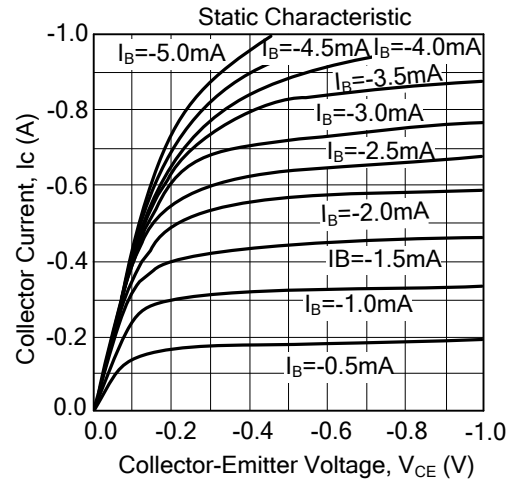
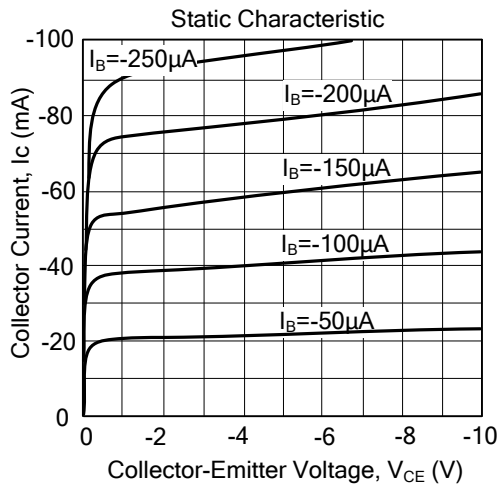

■ TYPICAL CHARACTERISTICS(Cont.)

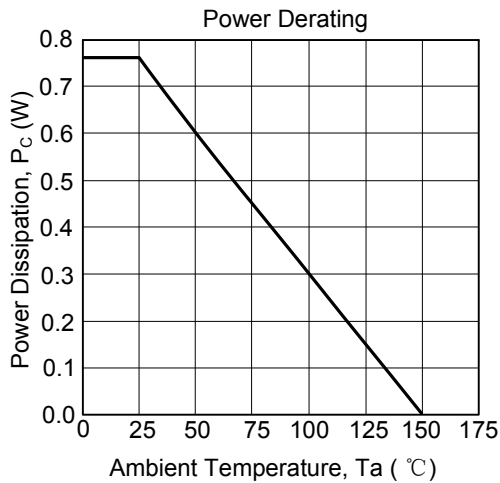
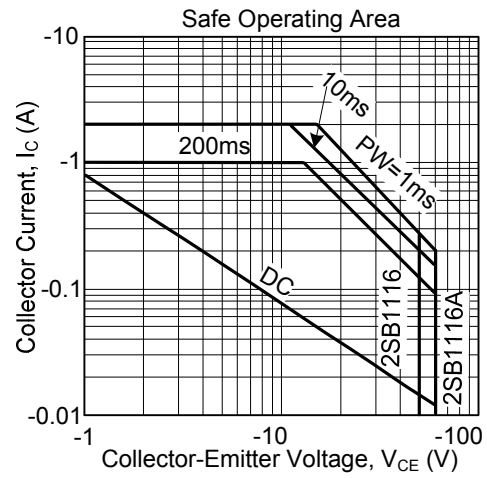
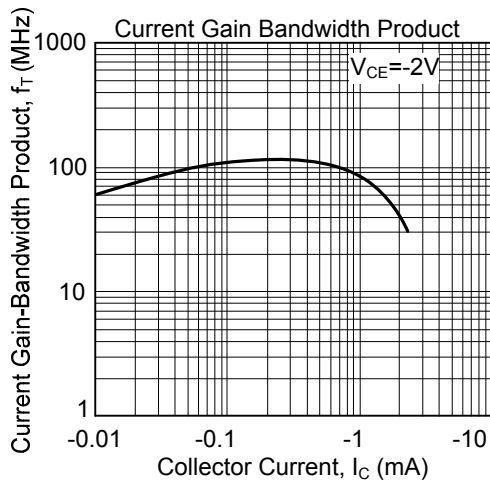

UTC assumes no responsibility for equipment failures that result from using products at values that exceed, even momentarily, rated values (such as maximum ratings, operating condition ranges, or other parameters) listed in products specifications of any and all UTC products described or contained herein. UTC products are not designed for use in life support appliances, devices or systems where malfunction of these products can be reasonably expected to result in personal injury. Reproduction in whole or in part is prohibited without the prior written consent of the copyright owner. The information presented in this document does not form part of any quotation or contract, is believed to be accurate and reliable and may be changed without notice.