



2SD1624

NPN SILICON TRANSISTOR

HIGH CURRENT SWITCHING APPLICATION

DESCRIPTION

The UTC **2SD1624** applies to voltage regulators, relay drivers, lamp drivers, and electrical equipment.

FEATURES

- * Adoption of FBET, MBIT processes
- * Low collector-to-emitter saturation voltage
- * Fast switching speed.
- * Large current capacity and wide ASO

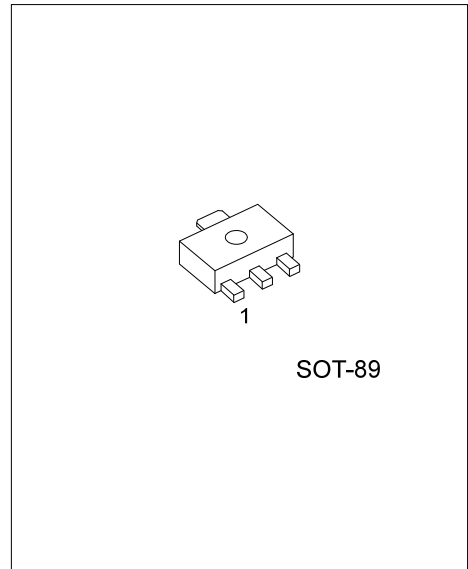

ORDERING INFORMATION

Order Number	Package	Pin Assignment			Packing
		1	2	3	
2SD1624G-x-AB3-R	SOT-89	B	C	E	Tape Reel

Note: Pin Assignment: B: Base C: Collector E: Emitter

<p>2SD1624G-x-AB3-R</p>	<p>(1) R: Tape Reel</p> <p>(2) AB3: SOT-89</p> <p>(3) x: refer to Classification of h_{FE}</p> <p>(4) G: Halogen Free and Lead Free</p>
-------------------------	--

MARKING

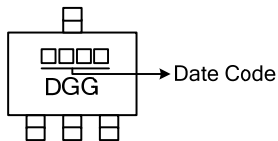

■ ABSOLUTE MAXIMUM RATINGS (T_A=25°C, unless otherwise specified)

PARAMETER	SYMBOL	RATINGS	UNIT
Collector-Base Voltage	V _{CBO}	60	V
Collector-Emitter Voltage	V _{CEO}	50	V
Emitter-Base Voltage	V _{EBO}	6	V
Collector Power Dissipation(T _c =25°C)	P _C	500	mW
Collector Current	DC	I _C	3
	PULSE	I _{CP}	6
Junction Temperature	T _J	150	°C
Storage Temperature	T _{STG}	-55 ~ +150	°C

Note: Absolute maximum ratings are those values beyond which the device could be permanently damaged.

Absolute maximum ratings are stress ratings only and functional device operation is not implied.

■ ELECTRICAL CHARACTERISTICS (T_A=25°C, unless otherwise specified)

PARAMETER	SYMBOL	TEST CONDITIONS	MIN	TYP	MAX	UNIT
Collector-Base Breakdown Voltage	BV _{CBO}	I _C =10μA, I _E =0	60			V
Collector-Emitter Breakdown Voltage	BV _{CEO}	I _C =1mA, R _{BE} =∞	50			V
Emitter-Base Breakdown Voltage	BV _{EBO}	I _E =10μA, I _C =0	6			V
Collector-Emitter Saturation Voltage	V _{CE(SAT)}	I _C =2A, I _B =100mA		0.19	0.5	V
Base-Emitter Saturation Voltage	V _{BE(SAT)}	I _C =2A, I _B =100mA		0.94	1.2	V
Collector Cut-Off Current	I _{CBO}	V _{CB} =40V, I _E =0			1	μA
Emitter Cut-Off Current	I _{EBO}	V _{EB} =4V, I _C =0			1	μA
DC Current Gain	h _{FE}	V _{CE} =2V, I _C =100mA	100		560	
Gain-Bandwidth Product	f _T	V _{CE} =10V, I _C =50mA		150		MHz
Output Capacitance	C _{OB}	V _{CE} =10V, f=1MHz		25		pF
Turn-ON Time	t _{ON}	See test circuit		70		ns
Storage Time	t _{STG}	See test circuit		650		ns
Fall Time	t _F	See test circuit		35		ns

■ CLASSIFICATION OF h_{FE}

RANK	R	S	T	U
RANGE	100-200	140-280	200-400	280-560

■ TEST CIRCUIT

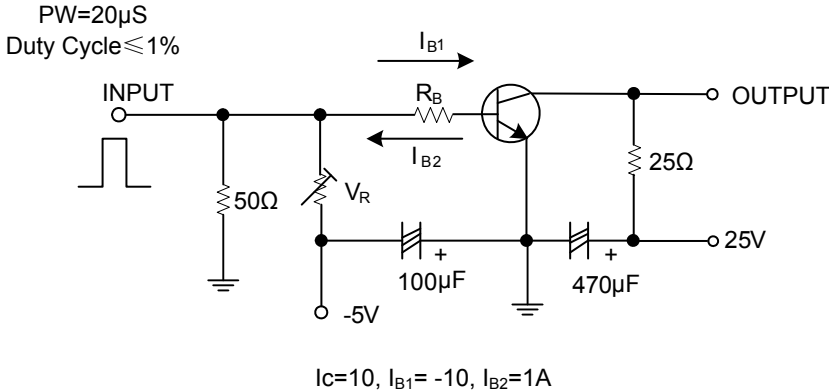

■ TYPICAL CHARACTERISTICS

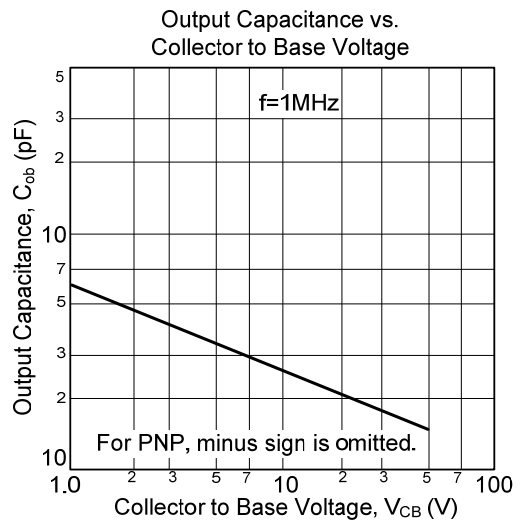
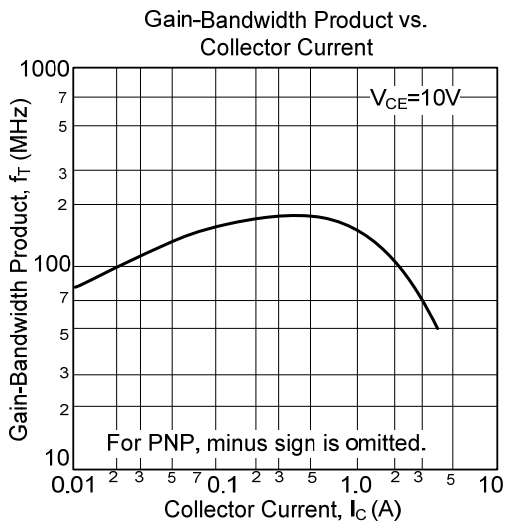
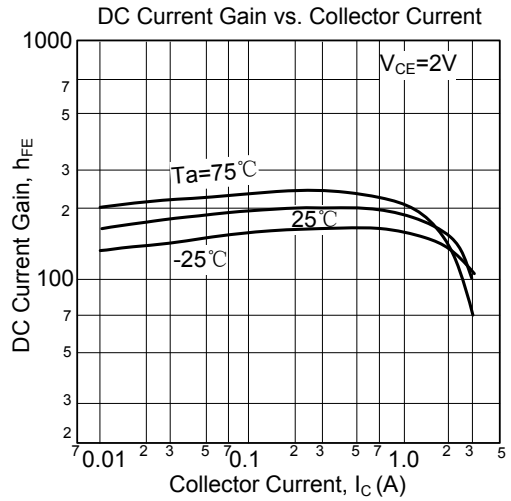
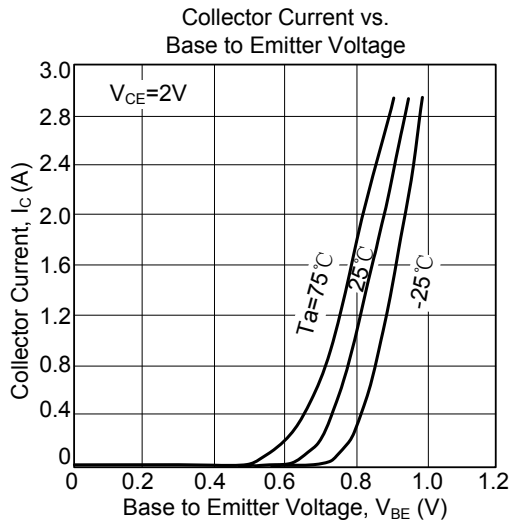
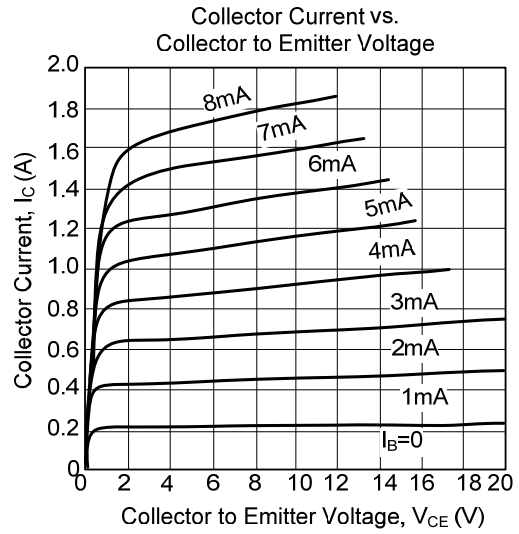
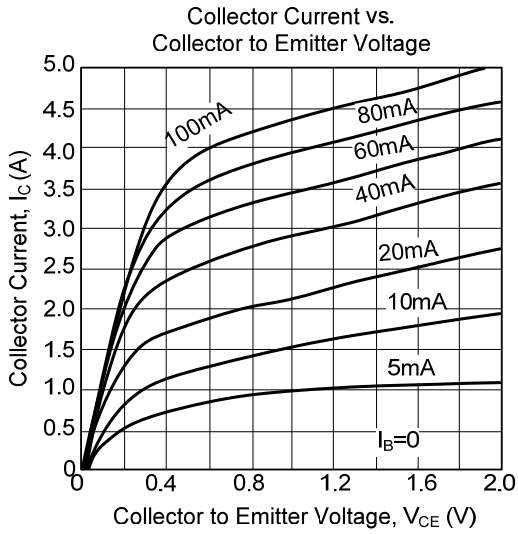

■ TYPICAL CHARACTERISTICS(Cont.)

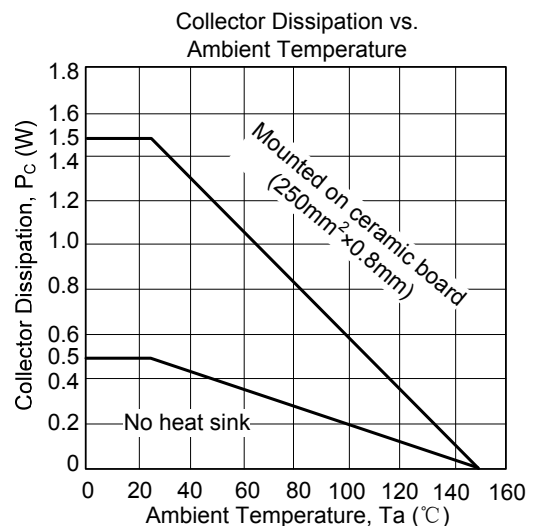
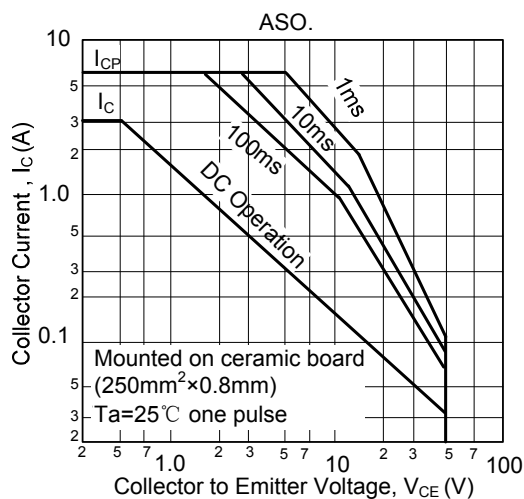
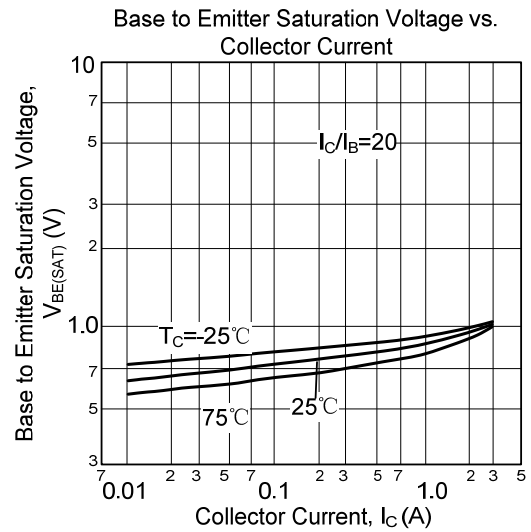
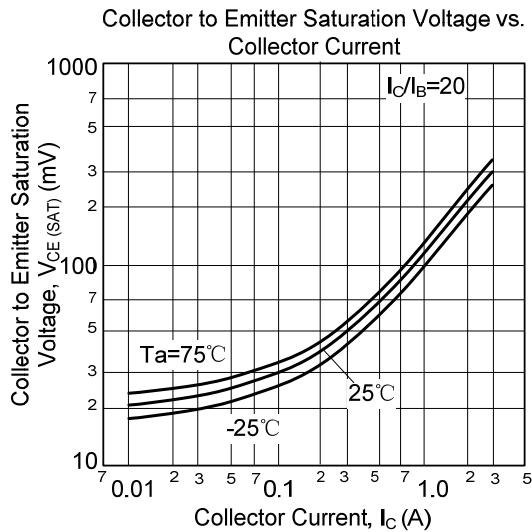

UTC assumes no responsibility for equipment failures that result from using products at values that exceed, even momentarily, rated values (such as maximum ratings, operating condition ranges, or other parameters) listed in products specifications of any and all UTC products described or contained herein. UTC products are not designed for use in life support appliances, devices or systems where malfunction of these products can be reasonably expected to result in personal injury. Reproduction in whole or in part is prohibited without the prior written consent of the copyright owner. The information presented in this document does not form part of any quotation or contract, is believed to be accurate and reliable and may be changed without notice.