



# 2N3904

## NPN SILICON TRANSISTOR

### NPN GENERAL PURPOSE AMPLIFIER

■ FEATURES

- \* Collector-Emitter Voltage:  $V_{CE0}=40V$
- \* Complementary to 2N3906

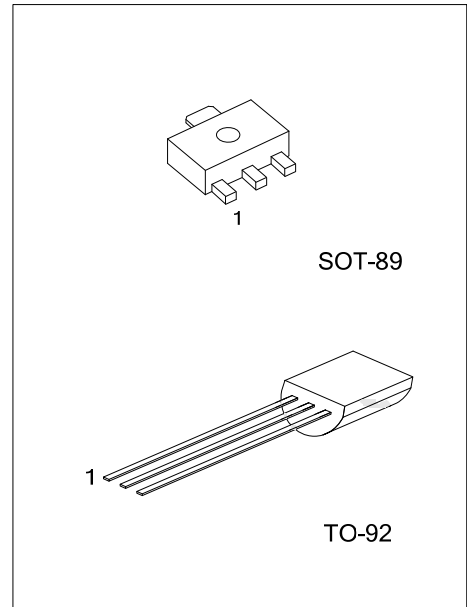

■ ORDERING INFORMATION

Ordering Number		Package	Pin Assignment			Packing
Lead Free	Halogen Free		1	2	3	
-	2N3904G-AB3-R	SOT-89	B	C	E	Tape Reel
2N3904L-T92-B	2N3904G-T92-B	TO-92	E	B	C	Tape Box
2N3904L-T92-K	2N3904G-T92-K	TO-92	E	B	C	Bulk

Note: Pin Assignment: B: Base C: Collector E: Emitter

<p>2N3904G-AB3-R</p>	<p>(1) B: Tape Box, K: Bulk, R: Tape Reel</p> <p>(2) AB3: SOT-89, T92: TO-92</p> <p>(3) G: Halogen Free and Lead Free, L: Lead Free</p>
----------------------	---

■ MARKING

SOT-89	TO-92

■ ABSOLUTE MAXIMUM RATING ( $T_A=25^\circ\text{C}$ , unless otherwise specified)

PARAMETER		SYMBOL	RATINGS	UNIT
Collector-Base Voltage		$V_{CBO}$	60	V
Collector-Emitter Voltage		$V_{CEO}$	40	V
Emitter-Base Voltage		$V_{EBO}$	6	V
Collector Current		$I_C$	200	mA
Collector Dissipation	SOT-89	$P_C$	500	mW
	TO-92		625	
Junction Temperature		$T_J$	150	$^\circ\text{C}$
Operating and Storage Temperature		$T_{STG}$	-55 ~ +150	$^\circ\text{C}$

Note: Absolute maximum ratings are those values beyond which the device could be permanently damaged. Absolute maximum ratings are stress ratings only and functional device operation is not implied.

■ THERMAL DATA

PARAMETER		SYMBOL	RATING	UNIT
Junction to Ambient	SOT-89	$\theta_{JA}$		$^\circ\text{C/W}$
	TO-92		200	$^\circ\text{C/W}$
Junction to Case	SOT-89	$\theta_{JC}$		$^\circ\text{C/W}$
	TO-92		83.3	$^\circ\text{C/W}$

■ ELECTRICAL CHARACTERISTICS ( $T_A=25^\circ\text{C}$ , unless otherwise specified)

PARAMETER	SYMBOL	TEST CONDITIONS	MIN	TYP	MAX	UNIT
Collector-Base Breakdown Voltage	$BV_{CBO}$	$I_C=10\mu\text{A}, I_E=0$	60			V
Collector-Emitter Breakdown Voltage	$BV_{CEO}$	$I_C=1\text{mA}, I_B=0$ (Note)	40			V
Emitter-Base Breakdown Voltage	$BV_{EBO}$	$I_E=10\mu\text{A}, I_C=0$	6			V
Collector-Emitter Saturation Voltage (Note)	$V_{CE(SAT)1}$	$I_C=10\text{mA}, I_B=1\text{mA}$			0.2	V
	$V_{CE(SAT)2}$	$I_C=50\text{mA}, I_B=5\text{mA}$			0.3	V
Base-Emitter Saturation Voltage (Note)	$V_{BE(SAT)1}$	$I_C=10\text{mA}, I_B=1\text{mA}$	0.65		0.85	V
	$V_{BE(SAT)2}$	$I_C=50\text{mA}, I_B=5\text{mA}$			0.95	V
Collector Cut-off Current	$I_{CBO}$	$V_{CE}=30\text{V}, V_{EB}=3\text{V}$			50	nA
Base Cut-off Current	$I_{BL}$	$V_{CE}=30\text{V}, V_{EB}=3\text{V}$			50	nA
DC Current Gain (note)	$h_{FE1}$	$V_{CE}=1\text{V}, I_C=0.1\text{mA}$	40			
	$h_{FE2}$	$V_{CE}=1\text{V}, I_C=1\text{mA}$	70			
	$h_{FE3}$	$V_{CE}=1\text{V}, I_C=10\text{mA}$	100		300	
	$h_{FE4}$	$V_{CE}=1\text{V}, I_C=50\text{mA}$	60			
	$h_{FE5}$	$V_{CE}=1\text{V}, I_C=100\text{mA}$	30			
Current Gain Bandwidth Product	$f_T$	$V_{CE}=20\text{V}, I_C=10\text{mA}, f=100\text{MHz}$	300			MHz
Output Capacitance	$C_{OB}$	$V_{CB}=5\text{V}, I_E=0, f=1\text{MHz}$			4	pF
Turn on Time	$t_{ON}$	$V_{CC}=3\text{V}, V_{BE}=0.5\text{V}, I_C=10\text{mA}, I_{B1}=1\text{mA}$			70	ns
Turn off Time	$t_{OFF}$	$I_{B1}=1\text{mA}, I_{B2}=1\text{mA}$			250	ns

Note: Pulse test: Pulse Width  $\leq 300\mu\text{s}$ , Duty Cycle  $\leq 2\%$

■ TYPICAL CHARACTERISTICS

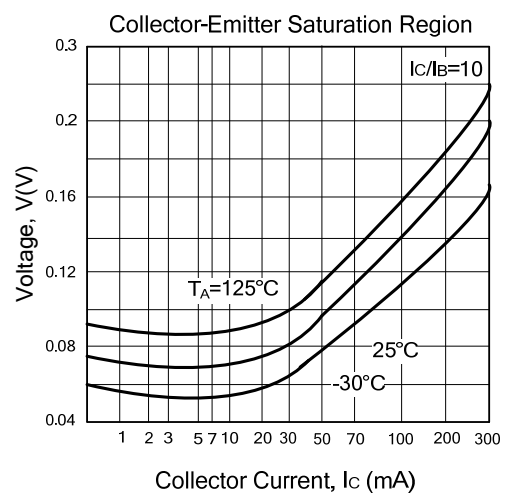
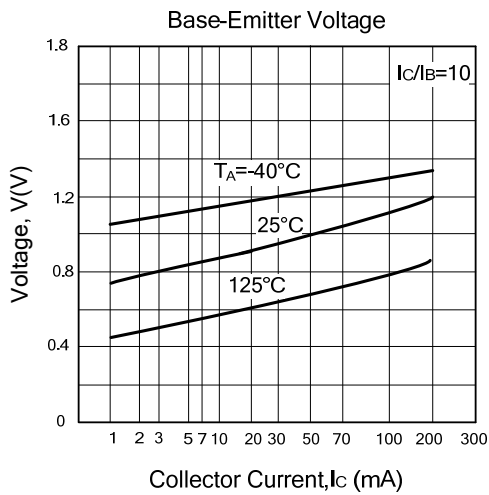
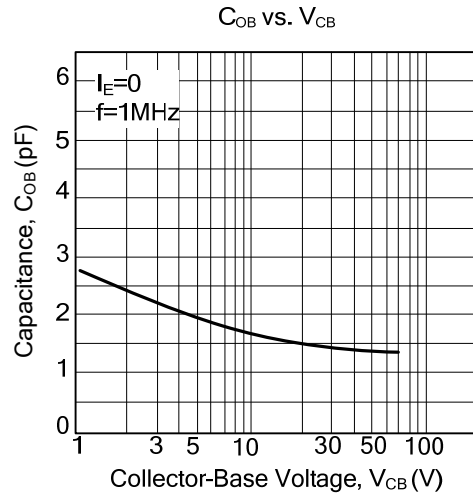
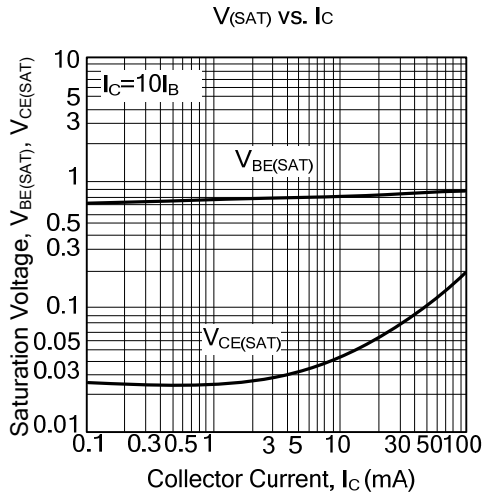
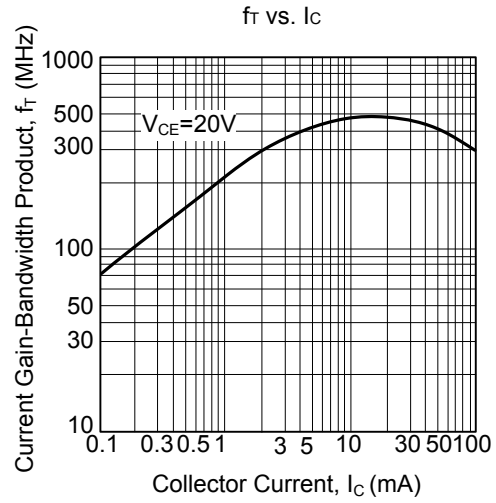
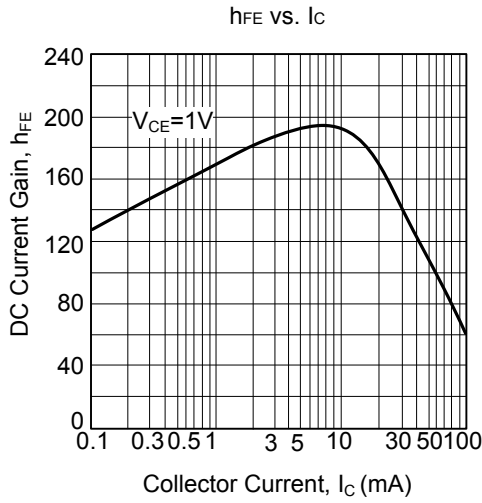

## ■ TYPICAL CHARACTERISTICS(Cont.)

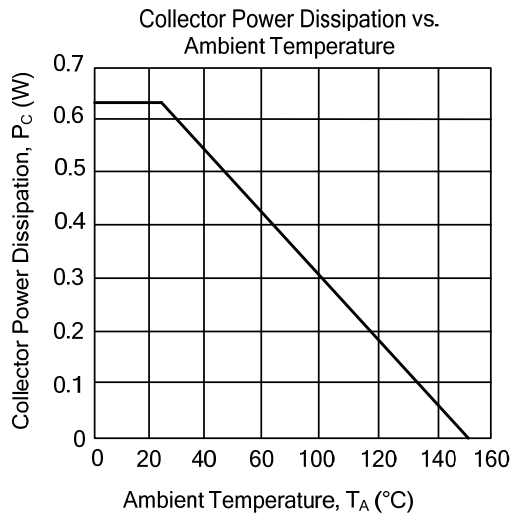

UTC assumes no responsibility for equipment failures that result from using products at values that exceed, even momentarily, rated values (such as maximum ratings, operating condition ranges, or other parameters) listed in products specifications of any and all UTC products described or contained herein. UTC products are not designed for use in life support appliances, devices or systems where malfunction of these products can be reasonably expected to result in personal injury. Reproduction in whole or in part is prohibited without the prior written consent of the copyright owner. The information presented in this document does not form part of any quotation or contract, is believed to be accurate and reliable and may be changed without notice.