



2SD1664

NPN SILICON TRANSISTOR

MEDIUM POWER NPN TRANSISTOR

DESCRIPTION

The UTC **2SD1664** is an epitaxial planar type NPN silicon transistor.

FEATURES

*Low $V_{CE(SAT)}$: $V_{CE(SAT)} = 0.15V(Typ.)$
($I_C/I_B = 500mA/50mA$)

* Complement the 2SB1132.

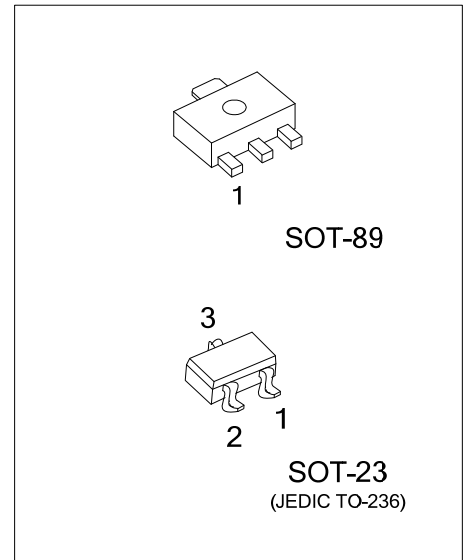

ORDERING INFORMATION

Order Number	Package	Pin Assignment			Packing
		1	2	3	
2SD1664G-x-AB3-R	SOT-89	B	C	E	Tape Reel
2SD1664G-x-AE3-R	SOT-23	E	B	C	Tape Reel

Note: Pin Assignment: B: Base C: Collector E: Emitter

<p>2SD1664G-x-AB3-R</p> <ul style="list-style-type: none"> (1) Packing Type (2) Package Type (3) Rank (4) Green Package 	<ul style="list-style-type: none"> (1) R: Tape Reel (2) AB3: SOT-89, AE3: SOT-23 (3) x: refer to Classification of h_{FE} (4) G: Halogen Free and Lead Free
---	--

MARKING

SOT-89	SOT-23
<p>2SD1664G → Data Code</p> <p>1</p>	<p>64G</p>

■ ABSOLUTE MAXIMUM RATINGS ($T_A=25^\circ\text{C}$, unless otherwise specified)

PARAMETER		SYMBOL	RATING	UNIT
Collector-Base Voltage		V_{CBO}	40	V
Collector-Emitter Voltage		V_{CEO}	32	V
Emitter-Base Voltage		V_{EBO}	5	V
Collector Current	DC	I_C	1	A
Collector Current (Duty=1/2, PW=20ms)	Pulse		2	A
Collector Power Dissipation	SOT-89	P_C	0.5	W
	SOT-23		0.3	W
Junction Temperature		T_J	+150	$^\circ\text{C}$
Storage Temperature		T_{STG}	-55 ~ +150	$^\circ\text{C}$

Note: Absolute maximum ratings are those values beyond which the device could be permanently damaged.

Absolute maximum ratings are stress ratings only and functional device operation is not implied.

■ ELECTRICAL CHARACTERISTICS ($T_A=25^\circ\text{C}$, unless otherwise specified)

PARAMETER	SYMBOL	TEST CONDITIONS	MIN	TYP	MAX	UNIT
Collector Base Breakdown Voltage	BV_{CBO}	$I_C=50\mu\text{A}$	40			V
Collector Emitter Breakdown Voltage	BV_{CEO}	$I_C=1\text{mA}$	32			V
Emitter Base Breakdown Voltage	BV_{EBO}	$I_E=50\mu\text{A}$	5			V
Collector Cut-Off Current	I_{CBO}	$V_{CB}=20\text{V}$			0.5	μA
Emitter Cut-Off Current	I_{EBO}	$V_{EB}=4\text{V}$			0.5	μA
DC Current Gain	h_{FE}	$V_{CE}=3\text{V}$, $I_C=100\text{mA}$	82		390	
Collector-Emitter Saturation Voltage	$V_{CE(SAT)}$	$I_C/I_B=500\text{mA}/50\text{mA}$		0.15	0.4	V
Transition Frequency	f_T	$V_{CE}=5\text{V}$, $I_E=-50\text{mA}$, $f=100\text{MHz}$		150		MHz
Output Capacitance	C_{ob}	$V_{CB}=10\text{V}$, $I_E=0\text{A}$, $f=1\text{MHz}$		15		pF

■ CLASSIFICATION OF h_{FE}

RANK	P	Q	R
RANGE	82-180	120-270	180-390

TYPICAL CHARACTERISTICS

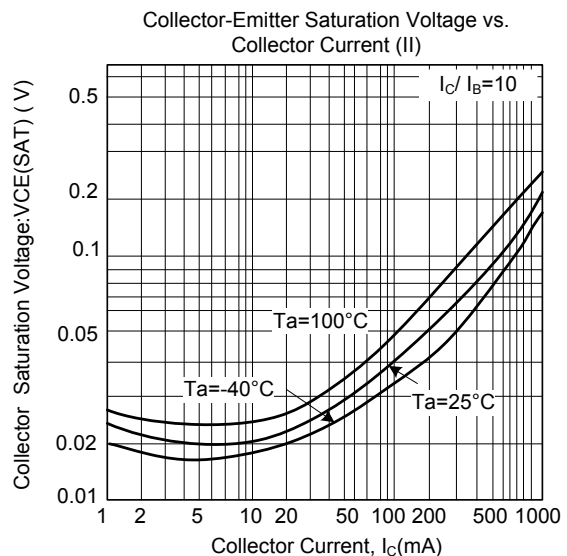
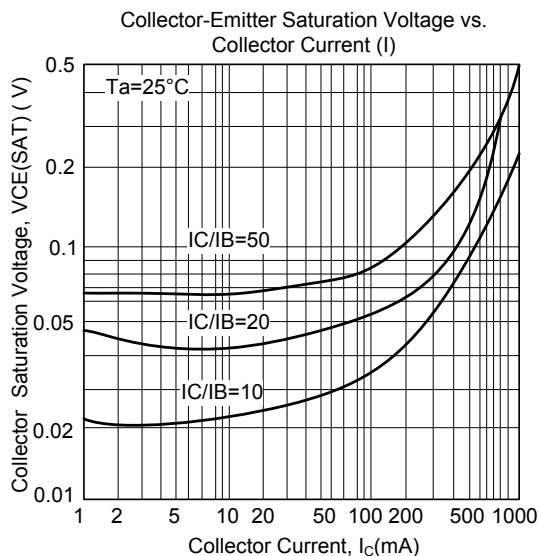
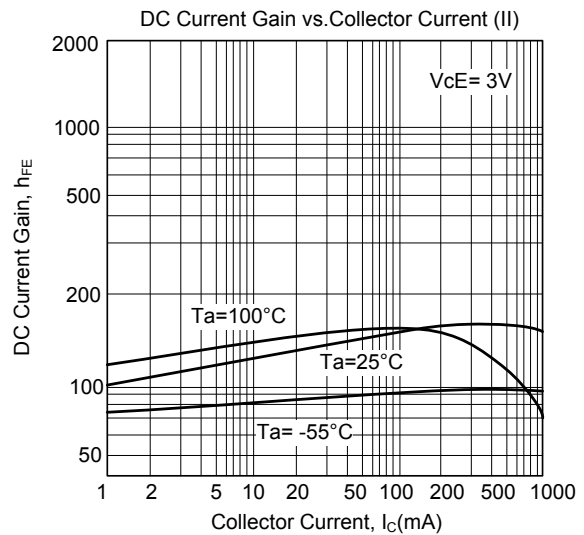
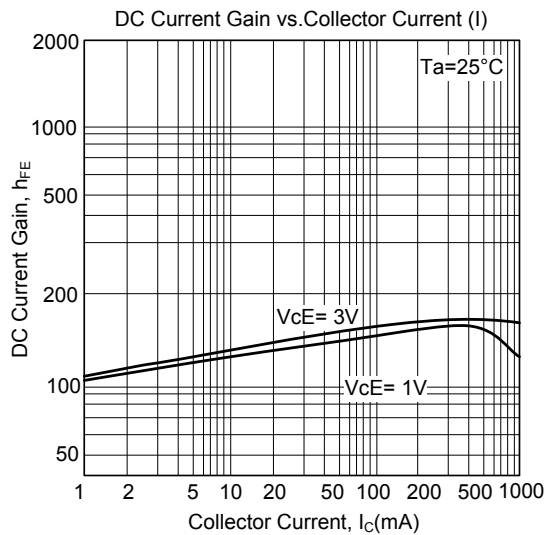
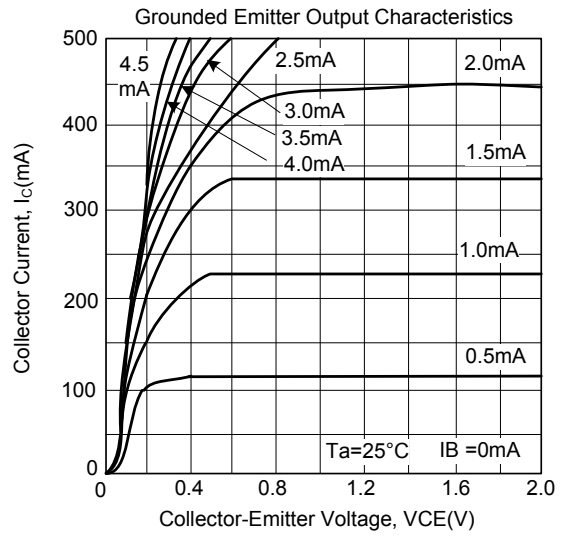
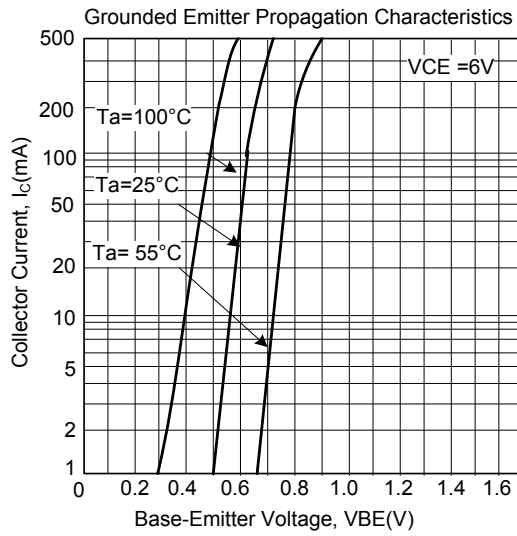

■ TYPICAL CHARACTERISTICS(Cont.)

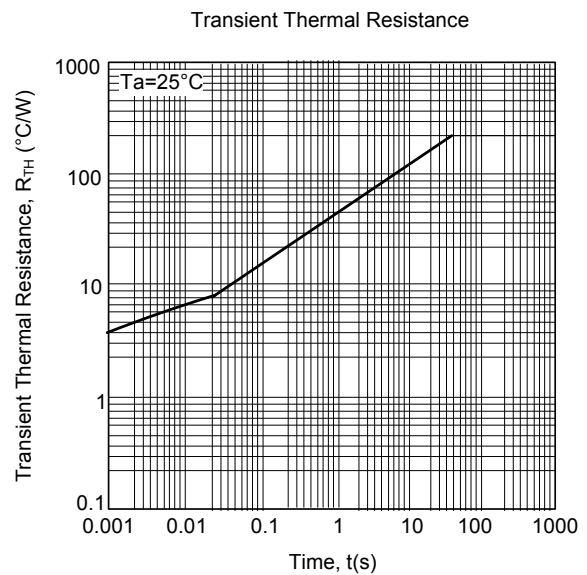
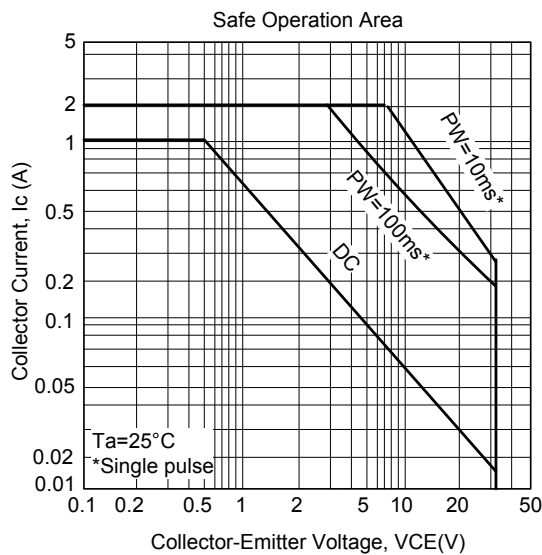
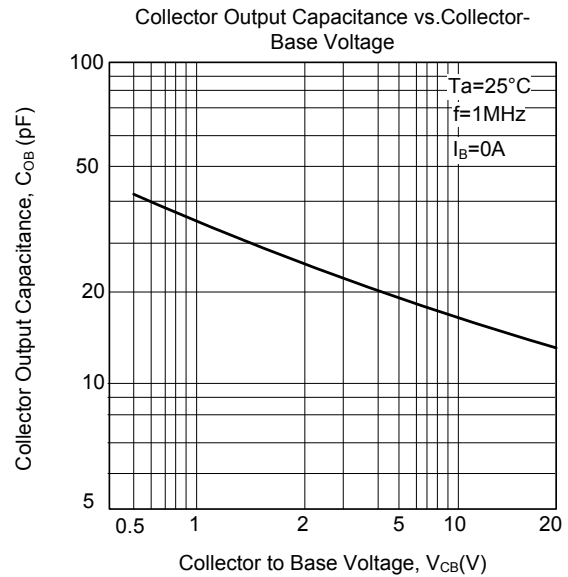
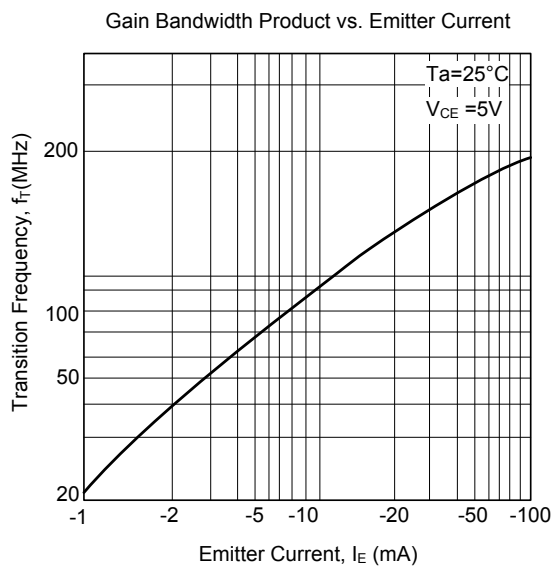

UTC assumes no responsibility for equipment failures that result from using products at values that exceed, even momentarily, rated values (such as maximum ratings, operating condition ranges, or other parameters) listed in products specifications of any and all UTC products described or contained herein. UTC products are not designed for use in life support appliances, devices or systems where malfunction of these products can be reasonably expected to result in personal injury. Reproduction in whole or in part is prohibited without the prior written consent of the copyright owner. The information presented in this document does not form part of any quotation or contract, is believed to be accurate and reliable and may be changed without notice.