



MMBT9018

NPN SILICON TRANSISTOR

AM/FM AMPLIFIER, LOCAL
OSCILLATOR OF FM/VHF
TUNER

FEATURES

- * High Current Gain Bandwidth Product
 $f_T = 1.1\text{GHz}$ (Typ)

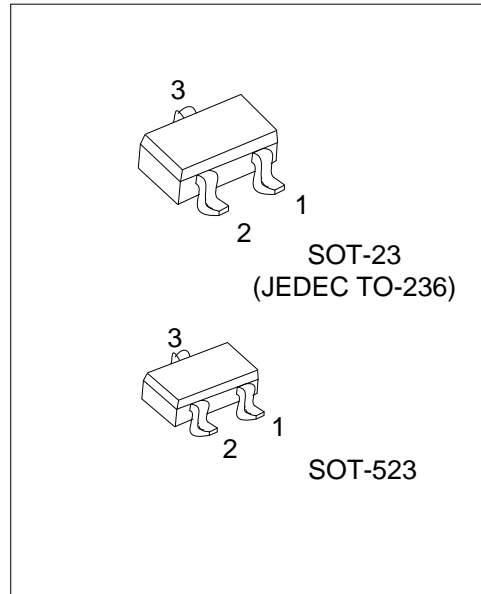

ORDERING INFORMATION

Ordering Number	Package	Pin Assignment			Packing
		1	2	3	
MMBT9018G-x-AE3-R	SOT-23	E	B	C	Tape Reel
MMBT9018G-x-AN3-R	SOT-523	E	B	C	Tape Reel

Note: Pin Assignment: E: Emitter B: Base C: Collector

<p>MMBT9018G-x-AE3-R</p> <p>(1) Packing Type (2) Package Type (3) Rank (4) Green Package</p>	<p>(1) R: Tape Reel (2) AE3: SOT-23, AN3: SOT-523 (3) x: refer to Classification of h_{FE} (4) G: Halogen Free and Lead Free</p>
--	---

MARKING

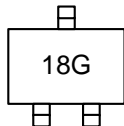

MMBT9018

NPN SILICON TRANSISTOR

■ ABSOLUTE MAXIMUM RATINGS ($T_A=25^\circ\text{C}$, unless otherwise specified)

PARAMETER		SYMBOL	RATINGS	UNIT
Collector-Base Voltage		V_{CBO}	30	V
Collector-Emitter Voltage		V_{CEO}	15	V
Emitter-Base Voltage		V_{EBO}	5	V
Collector Current		I_C	50	mA
Collector Power Dissipation	SOT-23	P_C	225	mW
	SOT-523		150	mW
Junction Temperature		T_J	+150	$^\circ\text{C}$
Storage Temperature		T_{STG}	-55 ~ +150	$^\circ\text{C}$

Note: Absolute maximum ratings are those values beyond which the device could be permanently damaged. Absolute maximum ratings are stress ratings only and functional device operation is not implied.

■ ELECTRICAL CHARACTERISTICS ($T_A=25^\circ\text{C}$, unless otherwise specified)

PARAMETER	SYMBOL	TEST CONDITIONS	MIN	TYP	MAX	UNIT
Collector-Base Breakdown Voltage	BV_{CBO}	$I_C=100\mu\text{A}$, $I_E=0$	30			V
Collector-Emitter Breakdown Voltage	BV_{CEO}	$I_C=1\text{mA}$, $I_B=0$	15			V
Emitter-Base Breakdown Voltage	BV_{EBO}	$I_E=100\mu\text{A}$, $I_C=0$	5			V
Collector Cut-Off Current	I_{CBO}	$V_{CB}=12\text{V}$, $I_E=0$			50	nA
Collector-Emitter Saturation Voltage	$V_{CE(SAT)}$	$I_C=10\text{mA}$, $I_B=1\text{mA}$			0.5	V
DC Current Gain	h_{FE}	$V_{CE}=5\text{V}$, $I_C=1\text{mA}$	28	100	198	
Current Gain Bandwidth Product	f_T	$V_{CE}=5\text{V}$, $I_C=5\text{mA}$	700	1100		MHz
Output Capacitance	C_{OB}	$V_{CB}=10\text{V}$, $I_E=0$, $f=1\text{MHz}$		1.3	1.7	pF

■ CLASSIFICATION of h_{FE}

RANK	D	E	F	G	H	I	J
RANGE	28-45	39-60	54-80	72-108	97-146	132-198	180-265

TYPICAL CHARACTERISTICS

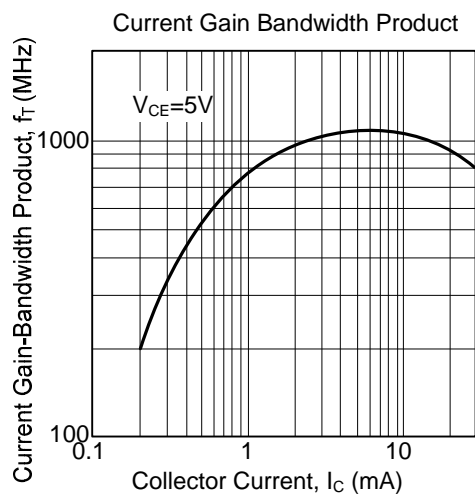
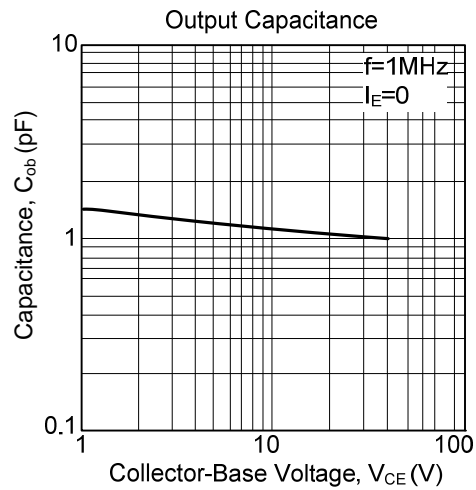
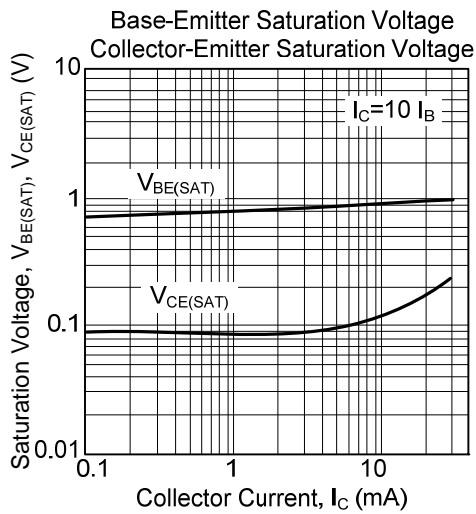
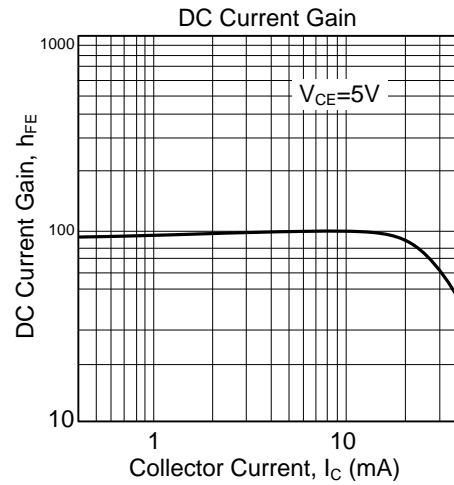
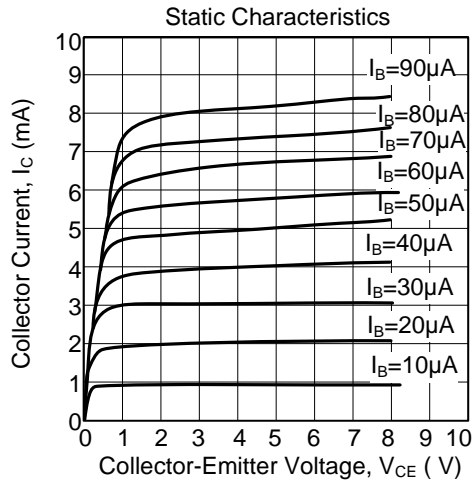

UTC assumes no responsibility for equipment failures that result from using products at values that exceed, even momentarily, rated values (such as maximum ratings, operating condition ranges, or other parameters) listed in products specifications of any and all UTC products described or contained herein. UTC products are not designed for use in life support appliances, devices or systems where malfunction of these products can be reasonably expected to result in personal injury. Reproduction in whole or in part is prohibited without the prior written consent of the copyright owner. The information presented in this document does not form part of any quotation or contract, is believed to be accurate and reliable and may be changed without notice.