



2SD669/A

NPN SILICON TRANSISTOR

BIPOLAR POWER GENERAL PURPOSE TRANSISTOR

■ APPLICATIONS

* Low frequency power amplifier complementary pair with UTC 2SB649/A

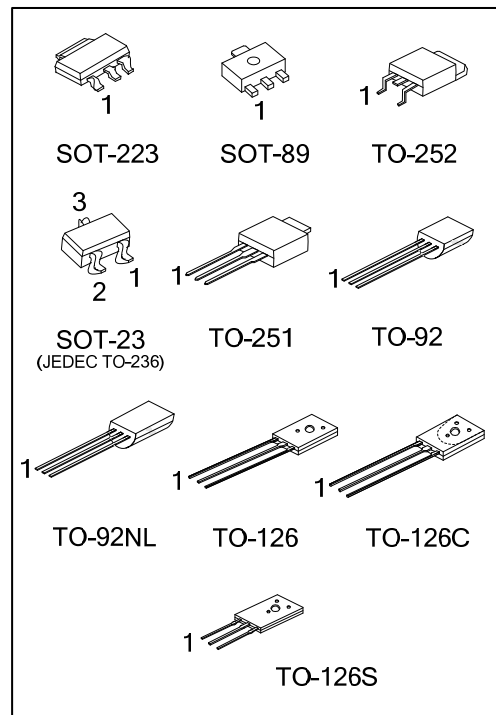

■ ORDERING INFORMATION

Ordering Number		Package	Pin Assignment			Packing
Lead Free	Halogen Free		1	2	3	
-	2SD669xG-x-AA3-R	SOT-223	B	C	E	Tape Reel
-	2SD669xG-x-AB3-R	SOT-89	B	C	E	Tape Reel
-	2SD669xG-x-AE3-R	SOT-23	B	E	C	Tape Reel
-	2SD669xG-x-AE3-6-R	SOT-23	E	B	C	Tape Reel
2SD669xL-x-T60-K	2SD669xG-x-T60-K	TO-126	E	C	B	Bulk
2SD669xL-x-T6C-K	2SD669xG-x-T6C-K	TO-126C	E	C	B	Bulk
2SD669xL-x-T6S-K	2SD669xG-x-T6S-K	TO-126S	E	C	B	Bulk
2SD669xL-x-T92-B	2SD669xG-x-T92-B	TO-92	E	C	B	Tape Box
2SD669xL-x-T92-K	2SD669xG-x-T92-K	TO-92	E	C	B	Bulk
2SD669xL-x-T9N-B	2SD669xG-x-T9N-B	TO-92NL	E	C	B	Tape Box
2SD669xL-x-T9N-K	2SD669xG-x-T9N-K	TO-92NL	E	C	B	Bulk
2SD669xL-x-TM3-T	2SD669xG-x-TM3-T	TO-251	B	C	E	Tube
2SD669xL-x-TN3-R	2SD669xG-x-TN3-R	TO-252	B	C	E	Tape Reel

Note: Pin Assignment: B: Base C: Collector E: Emitter

<p>2SD669xG-x-AE3-6-R</p> <p>(1) Packing Type (2) Pin Assignment (3) Package Type (4) Rank (5) Green Package (6) Collector-Emitter Voltage</p>	<p>(1) B: Tape Box, K: Bulk, R: Tape Reel, T: Tube (2) refer to Pin Assignment (3) AA3: SOT-223, AB3: SOT-89, AE3: SOT-23 T60: TO-126, T6C: TO-126C, T6S: TO-126S TM3: TO-251, TN3: TO-252, T92: TO-92 T9N: TO-92NL (4) x: refer to Classification of h_{FE1} (5) G: Halogen Free and Lead Free, L: Lead Free (6) A: 160V, Blank: 120V</p>
--------------------------------------------------------------------------------------------------------------------------------------------------------------------	-----------------------------------------------------------------------------------------------------------------------------------------------------------------------------------------------------------------------------------------------------------------------------------------------------------------------------------------------------------------------------------------

MARKING INFORMATION

PACKAGE	MARKING	
	2SD669	2SD669A
SOT-223		
SOT-89		
SOT-23		
TO-126 TO-126C TO-126S		
TO-92		
TO-92NL		
TO-251 TO-252		

■ ABSOLUTE MAXIMUM RATING ($T_A=25^{\circ}\text{C}$ unless otherwise specified)

PARAMETER		SYMBOL	RATINGS	UNIT
Collector-Base Voltage		V_{CBO}	180	V
Collector-Emitter Voltage	2SD669	V_{CEO}	120	V
	2SD669A		160	
Emitter-Base Voltage		V_{EBO}	5	V
Collector Current		I_C	1.5	A
Collector Peak Current		$I_{C(PK)}$	3	A
Base Current		I_B	0.5	A
Power Dissipation	SOT-223/ SOT-89	P_D	0.5	W
	SOT-23		0.35	W
	TO-126/TO-126S		1.3	W
	TO-126C		1	W
	TO-92/TO-92NL		0.6	W
	TO-251/TO-252		2	W
Junction Temperature		T_J	150	$^{\circ}\text{C}$
Storage Temperature		T_{STG}	-40 ~ +150	$^{\circ}\text{C}$

Notes: Absolute maximum ratings are those values beyond which the device could be permanently damaged.

Absolute maximum ratings are stress ratings only and functional device operation is not implied.

■ THERMAL DATA

PARAMETER		SYMBOL	RATINGS	UNIT
Junction to Case	SOT-89	θ_{JC}	38	$^{\circ}\text{C/W}$
	SOT-223		14	
	SOT-23		110	
	TO-92/TO-92NL		80	
	TO-126/TO-126S		6.25	
	TO-126C		10	
	TO-251/TO-252		4.5	

■ ELECTRICAL CHARACTERISTICS (T_A=25°C, unless otherwise specified)

PARAMETER	SYMBOL	TEST CONDITIONS	MIN	TYP	MAX	UNIT
OFF CHARACTERISTICS						
Collector to Base Breakdown Voltage	BV _{CBO}	I _C =1mA, I _E =0	180			V
Collector to Emitter Breakdown Voltage	2SD669	BV _{CEO} I _C =10mA, R _{BE} =∞	120			V
	2SD669A		160			
Collector to Emitter Breakdown Voltage (V _{BE} =0V)	2SD669	BV _{CES} I _C =1mA, V _{BE} =0V	120			V
	2SD669A		160			
Emitter to Base Breakdown Voltage	BV _{EBO}	I _E =1mA, I _C =0	5			V
Collector Cut-off Current	I _{CBO}	V _{CB} =160V, I _E =0			10	μA
Emitter Cutoff Current	I _{EBO}	V _{EB} =4V, I _C =0			10	μA
ON CHARACTERISTICS						
DC Current Gain	h _{FE1}	V _{CE} =5V, I _C =150mA (Note)	60		320	
	h _{FE2}	V _{CE} =5V, I _C =500mA (Note)	30			
Collector-Emitter Saturation Voltage	V _{CE(SAT)}	I _C =600mA, I _B =50mA (Note)			1	V
Base-Emitter Saturation Voltage	V _{BE(SAT)}	I _C =600mA, I _B =50mA (Note)			1.2	V
Base-Emitter Voltage	V _{BE}	V _{CE} =5V, I _C =150mA (Note)			1.5	V
DYNAMIC CHARACTERISTICS						
Current Gain Bandwidth Product	f _T	V _{CE} =5V, I _C =150mA (Note)		140		MHz
Output Capacitance	C _{ob}	V _{CB} =10V, I _E =0, f=1MHz		14		pF
SWITCHING CHARACTERISTICS						
Rise Time	t _R	V _{CC} =50V, I _C =0.5A, I _{B1} =I _{B2} =10mA, t _p =25μs, Duty Cycles≤1%		0.5		μs
Storage Time	t _S			1.5		
Fall Time	t _F			0.7		

Note: Pulse test.

■ CLASSIFICATION OF h_{FE1}

RANK	B	C	D
RANGE	60-120	100-200	160-320

TYPICAL CHARACTERISTICS

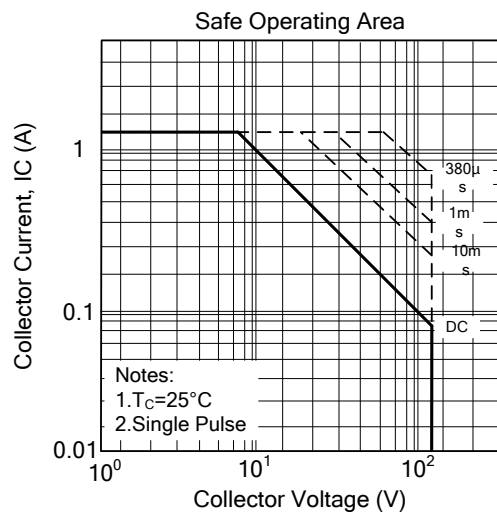
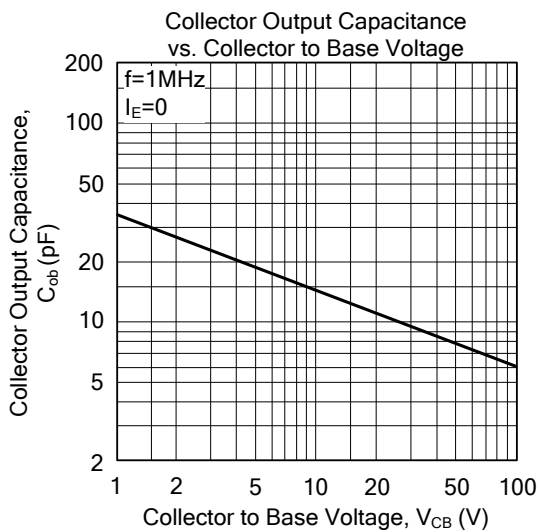
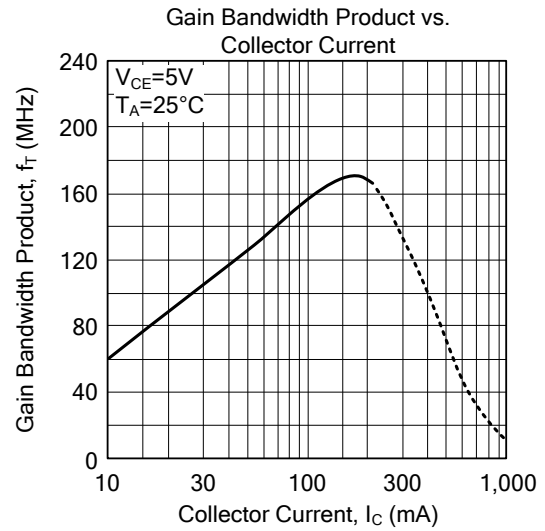
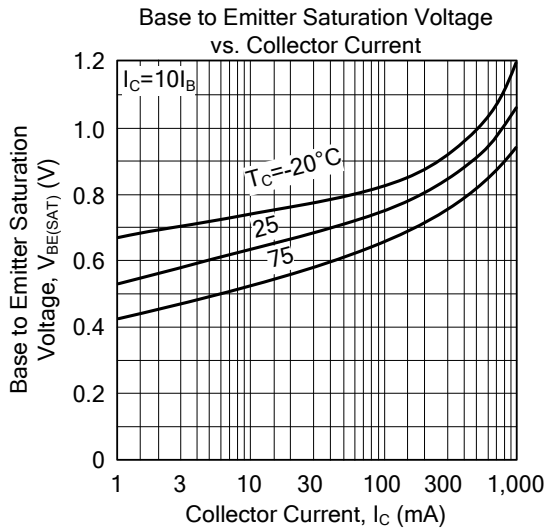
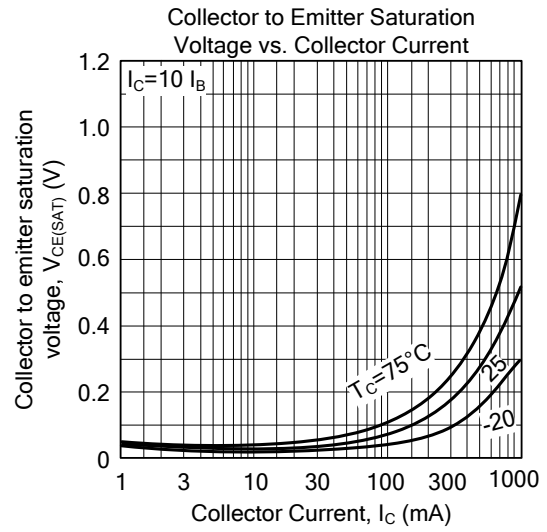
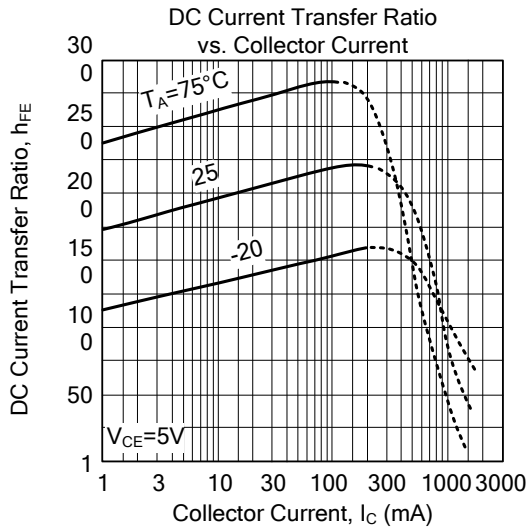

■ TYPICAL CHARACTERISTICS(Cont.)

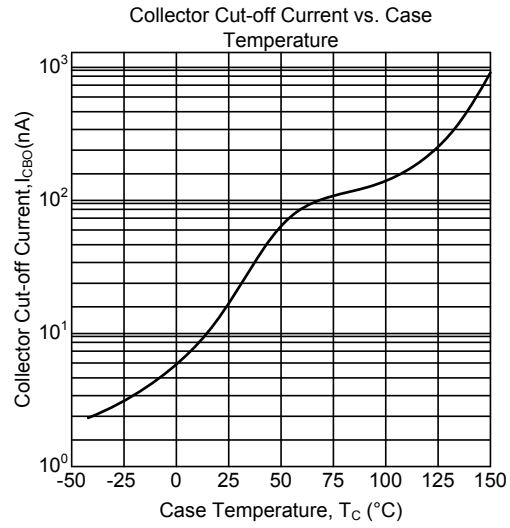
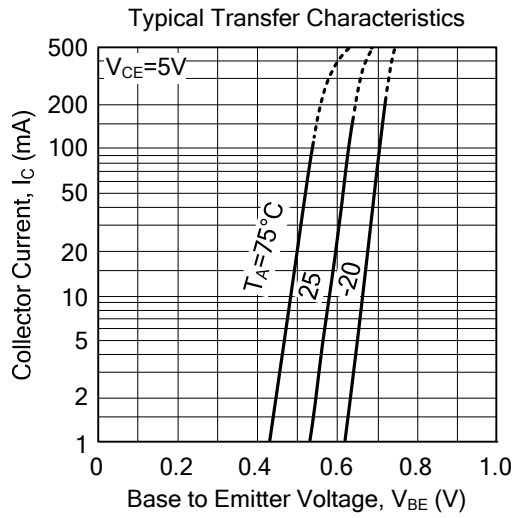

UTC assumes no responsibility for equipment failures that result from using products at values that exceed, even momentarily, rated values (such as maximum ratings, operating condition ranges, or other parameters) listed in products specifications of any and all UTC products described or contained herein. UTC products are not designed for use in life support appliances, devices or systems where malfunction of these products can be reasonably expected to result in personal injury. Reproduction in whole or in part is prohibited without the prior written consent of the copyright owner. The information presented in this document does not form part of any quotation or contract, is believed to be accurate and reliable and may be changed without notice.