



2SB1202

PNP PLANAR TRANSISTOR

HIGH CURRENT SWITCHING APPLICATION

■ DESCRIPTION

The UTC 2SB1202 applies to voltage regulators, relay drivers, lamp drivers, and electrical equipment.

■ FEATURES

- * Adoption of FBET, MBIT processes
- * Large current capacity and wide ASO
- * Low collector-to-emitter saturation voltage
- * Fast switching speed

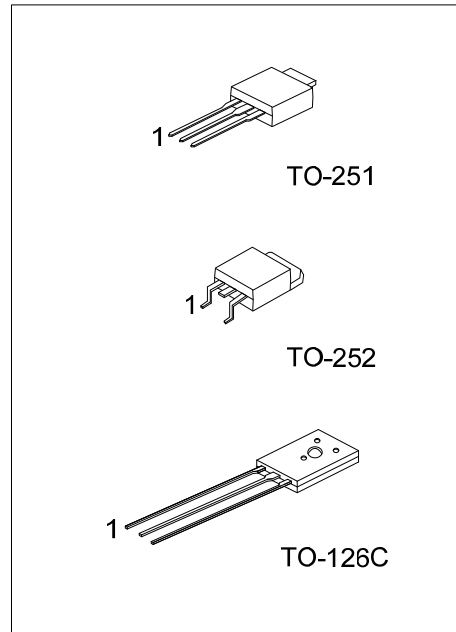

■ ORDERING INFORMATION

Order Number			Package	Pin Assignment			Packing
Normal	Lead Free Plating	Halogen Free		1	2	3	
2SB1202-x-T6C-K	2SB1202L-x-T6C-K	2SB1202G-x-T6C-K	TO-126C	E	C	B	Bulk
2SB1202-x-TM3-T	2SB1202L-x-TM3-T	2SB1202G-x-TM3-T	TO-251	B	C	E	Tube
2SB1202-x-TN3-R	2SB1202L-x-TN3-R	2SB1202G-x-TN3-R	TO-252	B	C	E	Tape Reel
2SB1202-x-TN3-T	2SB1202L-x-TN3-T	2SB1202G-x-TN3-T	TO-252	B	C	E	Tube

<p>2SB1202L-x-T6C-K</p>	<p>(1) K: Bulk, T: Tube, R: Tape Reel</p> <p>(2) T6C: TO-126C, TM3: TO-251, TN3: TO-252</p> <p>(3) x: refer to Classification of h_{FE1}</p> <p>(4) L: Lead Free Plating, G: Halogen Free, Blank: Pb/Sn</p>
-------------------------	--

■ ABSOLUTE MAXIMUM RATINGS (Ta=25°C, unless otherwise specified)

PARAMETER		SYMBOL	RATINGS	UNIT
Collector-Base Voltage		V _{CBO}	-60	V
Collector-Emitter Voltage		V _{CEO}	-50	V
Emitter-Base Voltage		V _{EBO}	-6	V
Collector Power Dissipation	T _c =25°C	TO-126C	20	W
		TO-251	28	W
		TO-252	28	W
Collector Current	DC	I _C	-3	A
	PULSE	I _{CP}	-6	A
Junction Temperature		T _J	150	°C
Storage Temperature		T _{STG}	-55 ~ +150	°C

Note: Absolute maximum ratings are those values beyond which the device could be permanently damaged. Absolute maximum ratings are stress ratings only and functional device operation is not implied.

■ THERMAL DATA

PARAMETER		SYMBOL	RATINGS	UNIT
Junction to Case	TO-126C	θ_{JC}	6.25	°C/W
	TO-251		4.53	
	TO-252		4.53	

■ ELECTRICAL CHARACTERISTICS (Ta=25°C, unless otherwise specified)

PARAMETER	SYMBOL	TEST CONDITIONS	MIN	TYP	MAX	UNIT
C-B Breakdown Voltage	BV _{CBO}	I _C =-10μA, I _E =0	-60			V
C-E Breakdown Voltage	BV _{CEO}	I _C =-1mA, R _{BE} =∞	-50			V
E-B Breakdown Voltage	BV _{EBO}	I _E =-10μA, I _C =0	-6			V
Collector Cutoff Current	I _{CBO}	V _{CB} =-40V, I _E =0			-1	μA
Emitter Cutoff Current	I _{EBO}	V _{EB} =-4V, I _C =0			-1	μA
C-E Saturation Voltage	V _{CE(SAT)}	I _C =-2A, I _B =-100mA		-0.35	-0.7	V
B-E Saturation Voltage	V _{BE(SAT)}	I _C =-2A, I _B =-100mA		-0.94	-1.2	V
DC Current Gain	h _{FE1}	V _{CE} =-2V, I _C =-100mA	100		560	
	h _{FE2}	V _{CE} =-2V, I _C =-3A	35			
Gain-Bandwidth Product	f _T	V _{CE} =-10V, I _C =-50mA		150		MHz
Output Capacitance	C _{ob}	V _{CB} =-10V, f=1MHz		39		pF
Turn-on Time	t _{ON}	See test circuit		70		ns
Storage Time	t _{STG}	See test circuit		450		ns
Fall Time	t _F	See test circuit		35		ns

■ CLASSIFICATION OF h_{FE1}

RANK	R	S	T	U
RANGE	100-200	140-280	200-400	280-560

■ TEST CIRCUIT

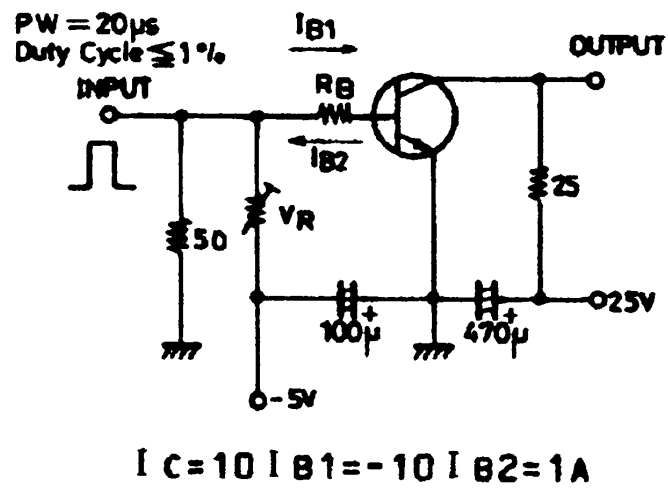

TYPICAL CHARACTERISTICS

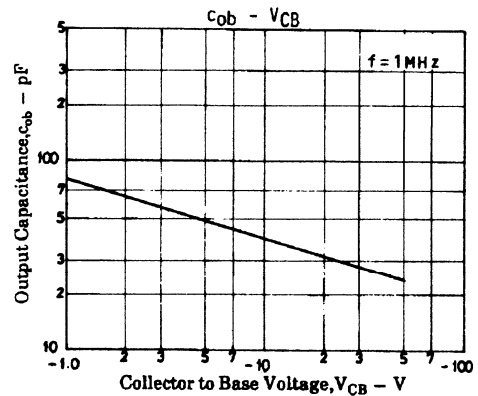
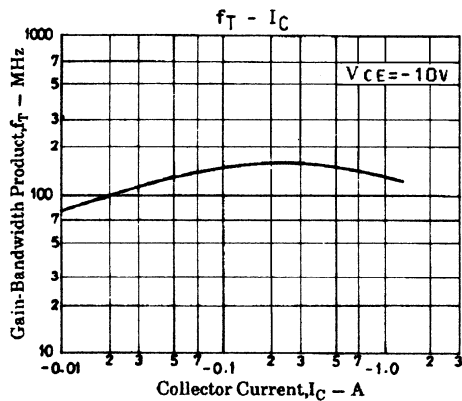
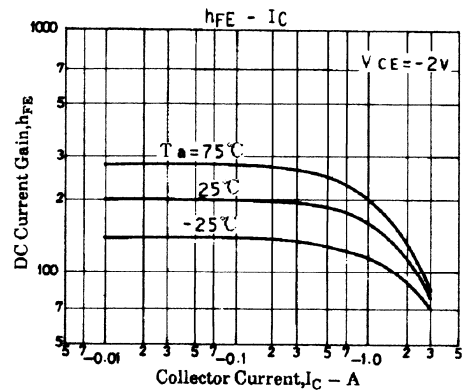
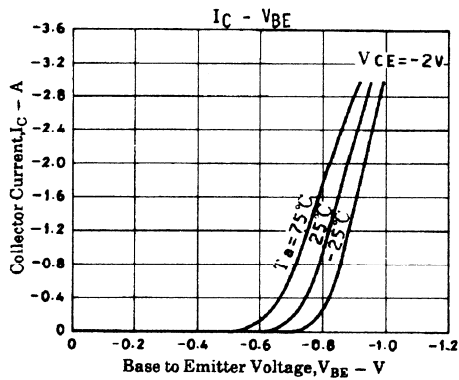
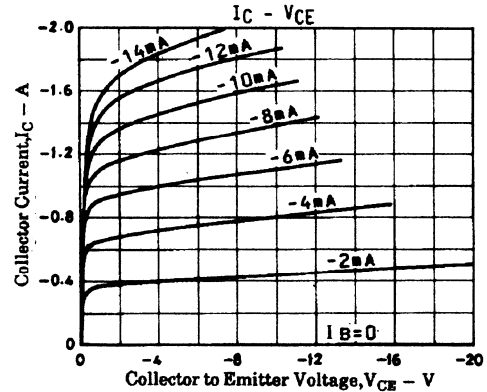
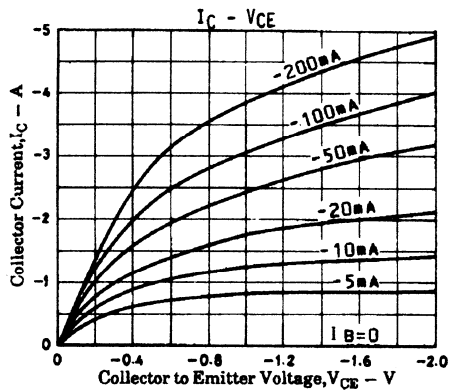

■ TYPICAL CHARACTERISTICS(Cont.)

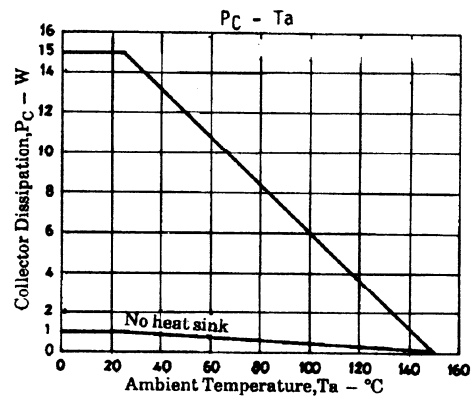
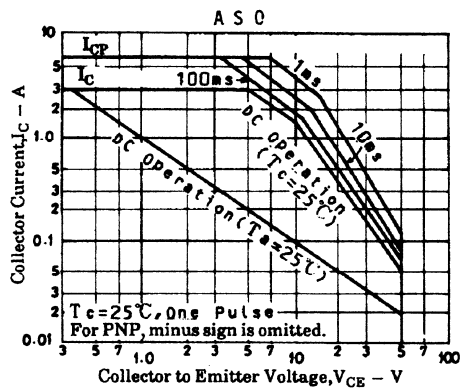
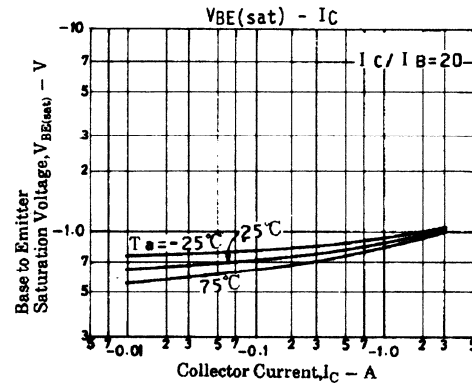
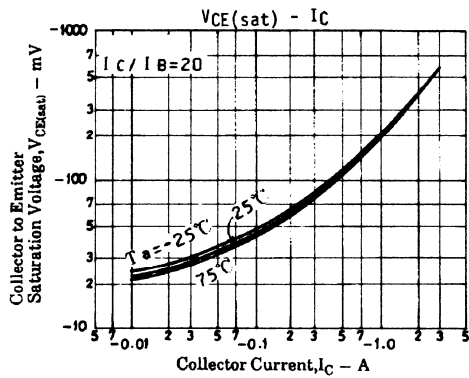

UTC assumes no responsibility for equipment failures that result from using products at values that exceed, even momentarily, rated values (such as maximum ratings, operating condition ranges, or other parameters) listed in products specifications of any and all UTC products described or contained herein. UTC products are not designed for use in life support appliances, devices or systems where malfunction of these products can be reasonably expected to result in personal injury. Reproduction in whole or in part is prohibited without the prior written consent of the copyright owner. The information presented in this document does not form part of any quotation or contract, is believed to be accurate and reliable and may be changed without notice.