

P-Channel Trench Power MOSFET

General Description

The HM2301B uses advanced trench technology to provide excellent $R_{DS(ON)}$, low gate charge and operation with gate voltages as low as $-2.5V$. This device is suitable for use as a battery protection or in other switching application.

Features

- $V_{DS} = -20V, I_D = -2.8A$
 $R_{DS(ON)} < 115m\Omega @ V_{GS} = -4.5V$
 $R_{DS(ON)} < 160m\Omega @ V_{GS} = -2.5V$
- High Power and current handing capability
- Lead free product is acquired
- Surface Mount Package

Application

- Battery protection
- Load switch
- Power management

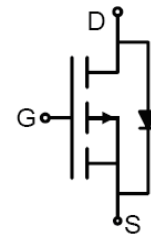

Schematic Diagram

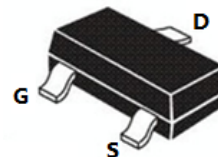

SOT-23 top view

Package Marking and Ordering Information

Device Marking	Device	Device Package	Reel Size	Tape width	Quantity
A1SHB	HM2301B	SOT-23	Ø180mm	8mm	3000units

Table 1. Absolute Maximum Ratings ($T_A=25^\circ C$)

Symbol	Parameter	Value	Unit
V_{DS}	Drain-Source Voltage ($V_{GS}=0V$)	-20	V
V_{GS}	Gate-Source Voltage ($V_{DS}=0V$)	± 12	V
I_D	Drain Current-Continuous	-2.8A	A
$I_{DM (pluse)}$	Drain Current-Continuous@ Current-Pulsed (Note 1)	-10	A
P_D	Maximum Power Dissipation	1	W
T_J, T_{STG}	Operating Junction and Storage Temperature Range	-55 To 150	$^\circ C$

Notes 1.Repetitive Rating: Pulse width limited by maximum junction temperature

Table 2. Thermal Characteristic

Symbol	Parameter	Value	Unit
$R_{\theta JA}$	Thermal Resistance, Junction-to-Ambient	125	$^\circ C/W$

Table 3. Electrical Characteristics (T_A=25°C unless otherwise noted)

Symbol	Parameter	Conditions	Min	Typ	Max	Unit
On/Off States						
B _V DSS	Drain-Source Breakdown Voltage	V _{GS} =0V, I _D =-250μA	-20	-23		V
I _{DSS}	Zero Gate Voltage Drain Current	V _{DS} =-20V, V _{GS} =0V			-1	μA
I _{GSS}	Gate-Body Leakage Current	V _{GS} =±12V, V _{DS} =0V			±100	nA
V _{GS(th)}	Gate Threshold Voltage	V _{DS} =V _{GS} , I _D =-250μA	-0.4	-0.7	-1	V
g _{FS}	Forward Transconductance	V _{DS} =-5V, I _D =-2A	4			S
R _{DS(ON)}	Drain-Source On-State Resistance	V _{GS} =-4.5V, I _D =-2.8A		83	115	mΩ
		V _{GS} =-2.5V, I _D =-2A		115	160	mΩ
		V _{GS} =-1.8V, I _D =-2A		250	320	mΩ
Dynamic Characteristics						
C _{ISS}	Input Capacitance	V _{DS} =-10V, V _{GS} =0V, f=1.0MHz		290		pF
C _{OSS}	Output Capacitance			55		pF
C _{RSS}	Reverse Transfer Capacitance			29		pF
Switching Times						
t _{d(on)}	Turn-on Delay Time	V _{DD} =-10V, I _D =-1A, R _L =2.8Ω V _{GS} =-4.5V, R _G =6Ω		8		nS
t _r	Turn-on Rise Time			13		nS
t _{d(off)}	Turn-Off Delay Time			13		nS
t _f	Turn-Off Fall Time			18		nS
Q _g	Total Gate Charge	V _{DS} =-10V, I _D =-2.5A, V _{GS} =-4.5V		3		nC
Q _{gs}	Gate-Source Charge			0.7		nC
Q _{gd}	Gate-Drain Charge			0.8		nC
Source-Drain Diode Characteristics						
I _{SD}	Source-Drain Current(Body Diode)				-2.5	A
V _{SD}	Forward on Voltage ^(Note 1)	V _{GS} =0V, I _S =-2.5A			-1.2	V

Notes 1. Repetitive Rating: Pulse width limited by maximum junction temperature.

Switch Time Test Circuit and Switching Waveforms:

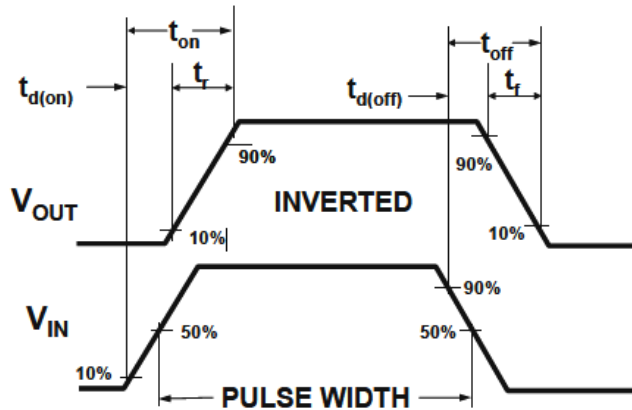
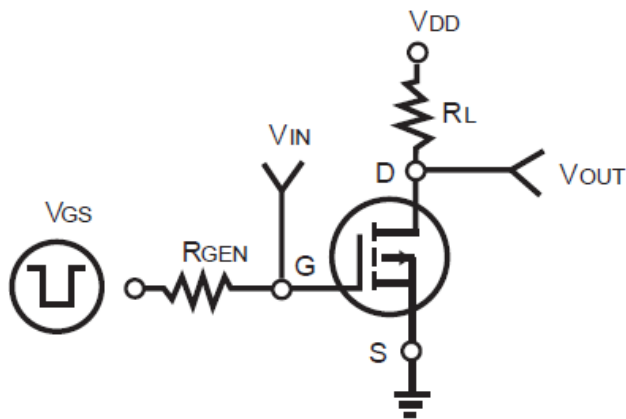

TYPICAL ELECTRICAL AND THERMAL CHARACTERISTICS (Curves)

Figure1. Power Dissipation

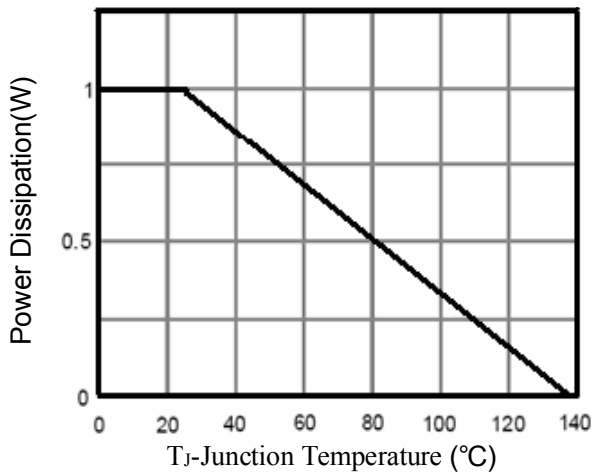

Figure2. Drain Current

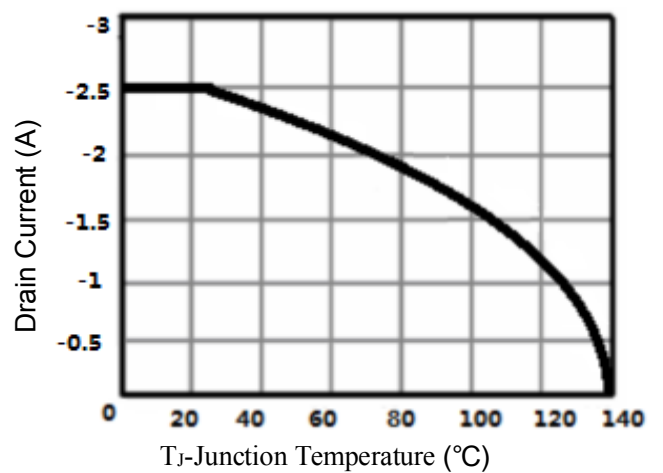

Figure3. Output Characteristics

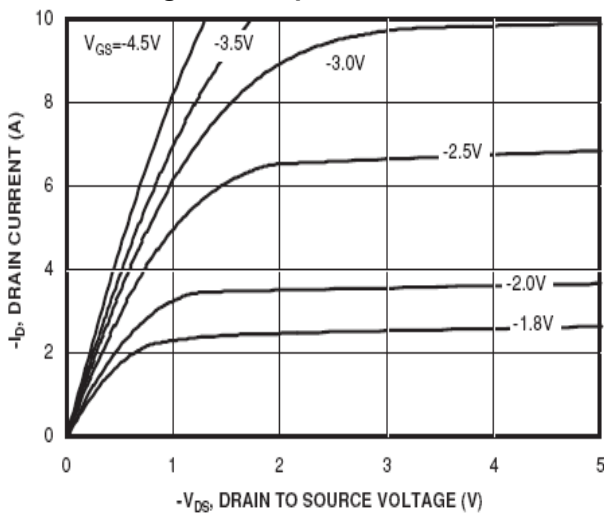

Figure4. Transfer Characteristics

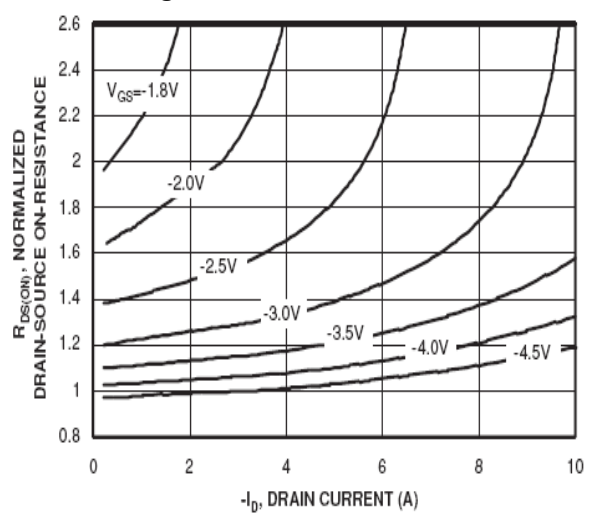

Figure5. Capacitance

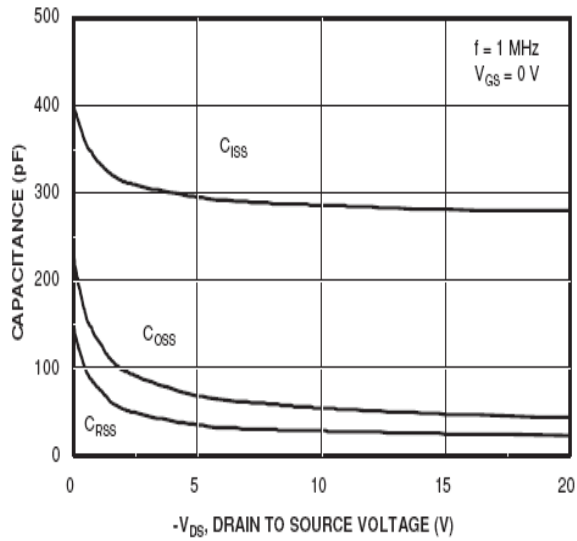

Figure6. $R_{DS(ON)}$ vs Junction Temperature

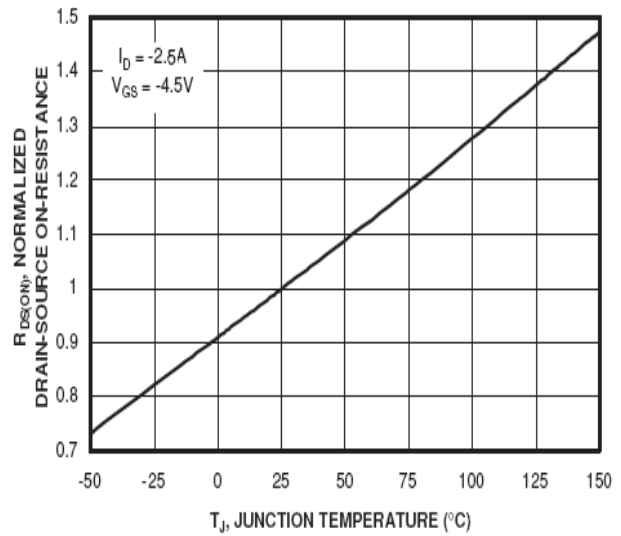

Figure7. Max BV_{DSS} vs Junction Temperature

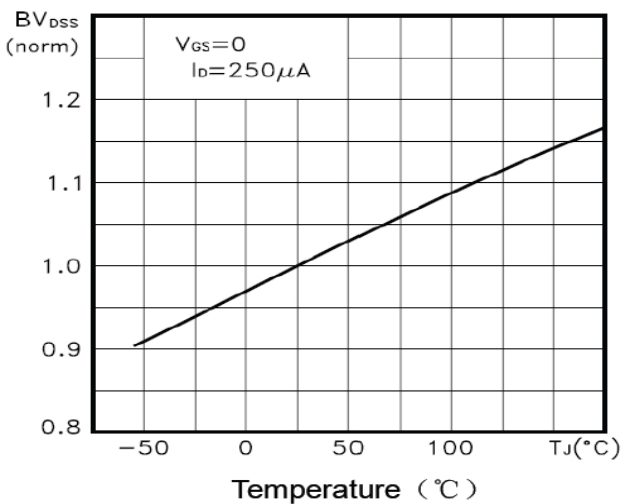

Figure8. $V_{GS(th)}$ vs Junction Temperature

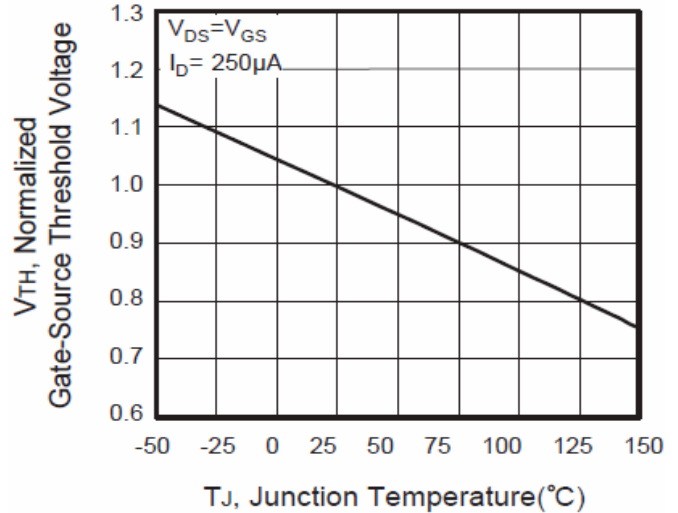

Figure9. Gate Charge Waveforms

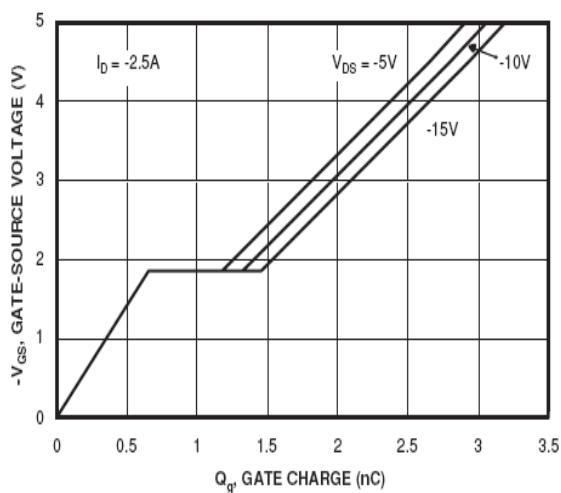

Figure10. Maximum Safe Operating Area

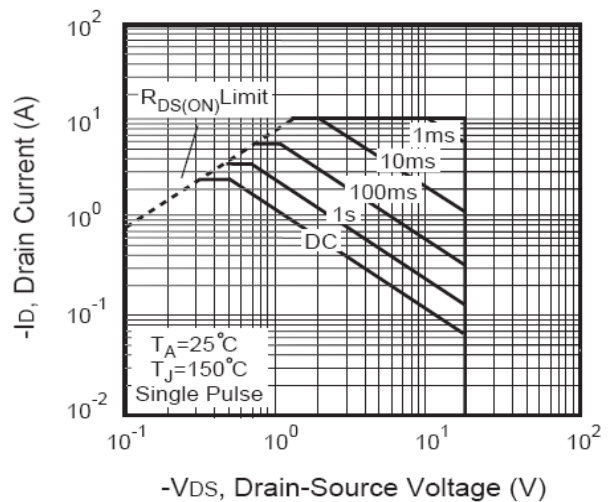
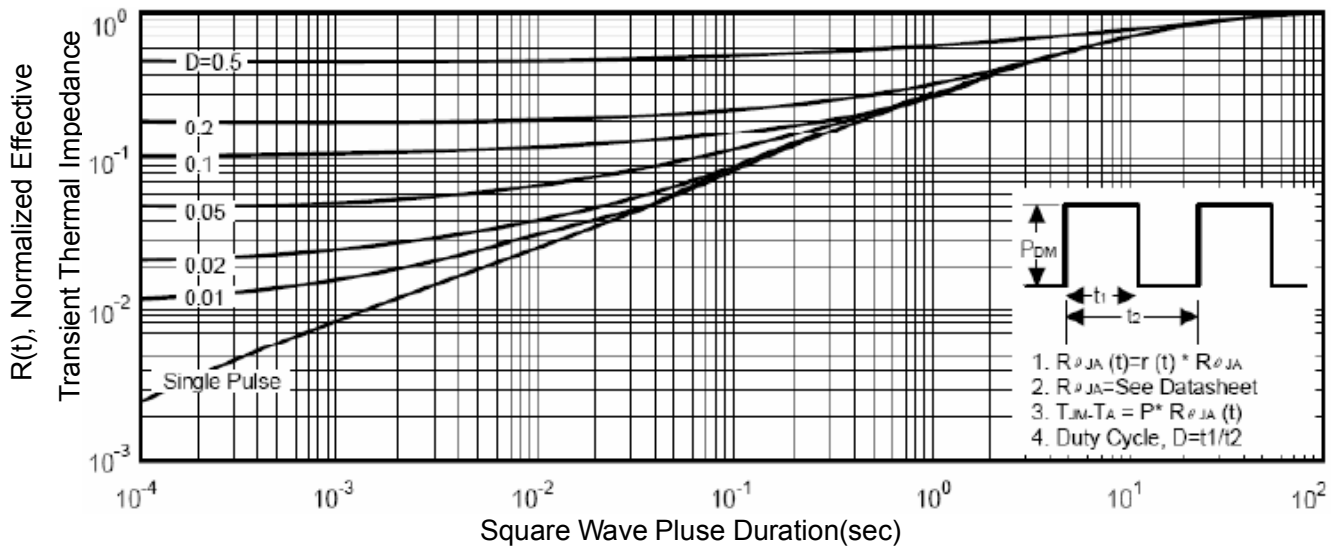
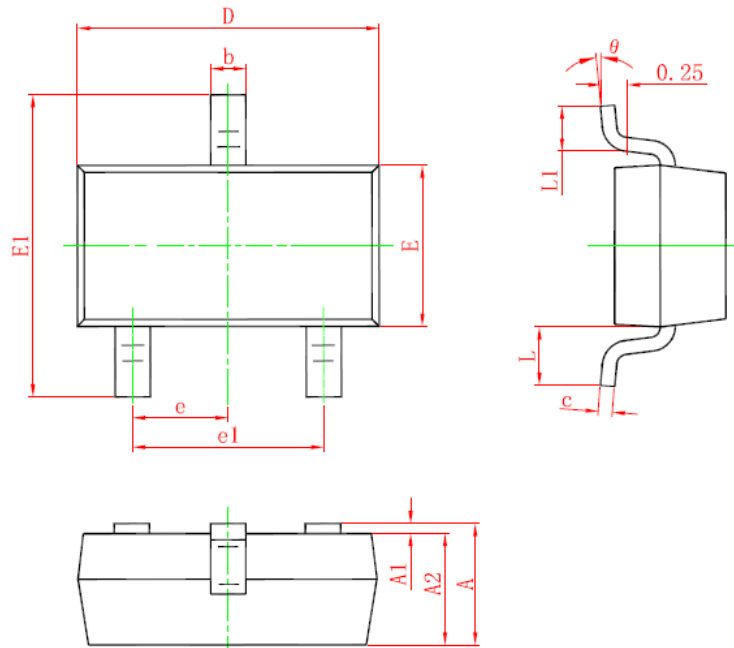

Figure11. Normalized Maximum Transient Thermal Impedance



SOT-23 Package Information



Symbol	Dimensions In Millimeters		Dimensions In Inches	
	Min.	Max.	Min.	Max.
A	0.900	1.150	0.035	0.045
A1	0.000	0.100	0.000	0.004
A2	0.900	1.050	0.035	0.041
b	0.300	0.500	0.012	0.020
c	0.080	0.150	0.003	0.006
D	2.800	3.000	0.110	0.118
E	1.200	1.400	0.047	0.055
E1	2.250	2.550	0.089	0.100
e	0.950 TYP.		0.037 TYP.	
e1	1.800	2.000	0.071	0.079
L	0.550 REF.		0.022 REF.	
L1	0.300	0.500	0.012	0.020
θ	0°	8°	0°	8°