

XC6219 Series

High Speed LDO Regulators, Low ESR Cap. Compatible, ON/OFF Switch



October 4, 2004 V5

- CMOS Low Power Consumption
- Dropout Voltage 60mV @ 30mA
200mV @ 100mA
- Output Current 150mA (VOUT<1.75V)
240mA (VOUT≥1.8V)
(300mA limit)
- Highly Accurate ± 2%
(±30mV when VOUT>1.5V)
- Output Voltage Range 0.9V to 5.0V (50mV increments)
- Low ESR Ceramic Capacitor Compatible

■ GENERAL DESCRIPTION

The XC6219 series are highly accurate, low noise, CMOS LDO Voltage Regulators. Offering low output noise, high ripple rejection ratio, low dropout and very fast turn-on times, the XC6219 series is ideal for today's cutting edge mobile phone.

Internally the XC6219 includes a reference voltage source, error amplifiers, driver transistors, current limiters and phase compensators. The XC6219's current limiters' foldback circuit also operates as a short protect for the output current limiter and the output pin. The output voltage is set by laser trimming.

Voltages are selectable in 50mV steps within a range of 0.9V to 5.0V. The XC6219 series is also fully compatible with low ESR ceramic capacitors, reducing cost and improving output stability. This high level of output stability is maintained even during frequent load fluctuations, due to the excellent transient response performance and high PSRR achieved across a broad range of frequencies.

The CE function allows the output of regulator to be turned off, resulting in greatly reduced power consumption.

The XC6219 series is available in the SOT-25 (SOT-23-5), SOT-89 or USP-6B 'chip-scale' package. Measuring only 2.0mm x 1.8mm the USP-6B is perfect for applications where PCB area is critical.

■ TYPICAL APPLICATION CIRCUIT

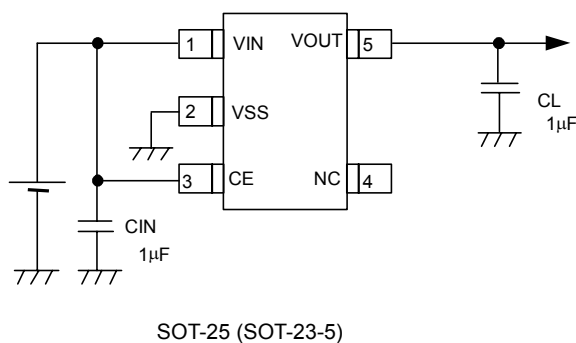

■ APPLICATIONS

- Mobile phones
- Cordless phones and radio communication equipment
- Portable games
- Cameras, video cameras
- Reference voltage sources
- Battery powered equipment

■ FEATURES

Maximum Output Current	150mA (VOUT<1.75V) 240mA (VOUT≥1.8V) (300mA limit (TYP))
Dropout Voltage	200mV (IOUT=100mA)
Operating Voltage Range	2.0V ~ 6.0V
Output Voltage Range	0.9V ~ 5.0V (50mV steps)
Highly Accurate	± 2% (VOUT>1.5V) ±30mV (VOUT≤1.5V)
Low Power Consumption	25µA (TYP.)
Standby Current	Less than 0.1µA (TYP.)
High Ripple Rejection	65dB (10kHz)
Operating Temperature Range	- 40°C to 85°C
Low ESR Ceramic Compatible	Ceramic Capacitor
Ultra Small Packages	SOT-25 (SOT-23-5) SOT-89 USP-6B

■ TYPICAL PERFORMANCE CHARACTERISTICS

- Ripple Rejection Rate

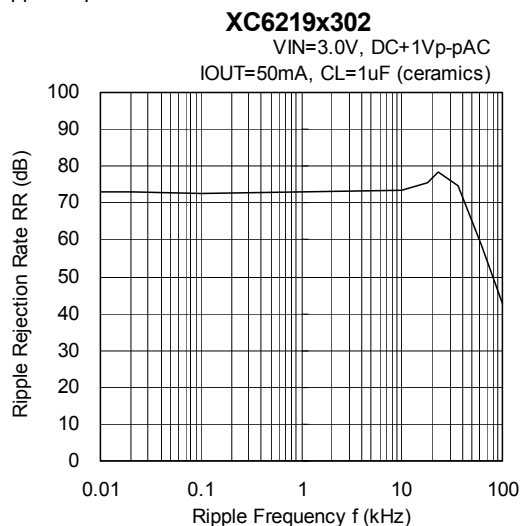

XC6219 Series

High Speed LDO Regulators, Low ESR Cap. Compatible, ON/OFF Switch



PIN CONFIGURATION

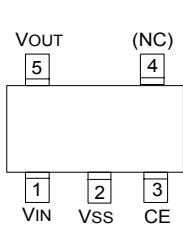

SOT-25 (SOT-23-5)
(TOP VIEW)

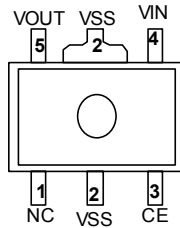

SOT-89-5
(TOP VIEW)

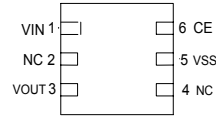

USP-6B
(BOTTOM VIEW)

*Please use the circuit without connecting to the heat dissipation pad.
If the pad needs to be connected to other pins, it should be noted that the pin configuration of the USP-6B package is different depending on the IC series.

PIN ASSIGNMENT

PIN NUMBER			PIN NAME	FUNCTIONS
SOT-25	SOT-89-5	USP-6B		
1	4	1	VIN	Power Input
2	2	5	VSS	Ground
3	3	6	CE	ON / OFF Control
4	1	2, 4	NC	No Connection
5	5	3	VOUT	Output

PRODUCT CLASSIFICATION

○ Selection Guide

The following options for the CE pin logic and internal pull-up/down are available:

- High Active + no pull-down resistor built-in (standard)
- High Active + 2.0MΩ pull-down resistor built-in <between CE-VSS> (semi-custom)
- Low Active + no pull-up resistor built-in (semi-custom)
- Low Active + 2.0MΩ pull-up resistor built-in <between VIN-CE> (semi-custom)

Note: *With the pull-up resistor or pull-down resistor built-in types, the supply current during operation will increase by $VIN / 2.0M\Omega$ (TYP.)

○ Ordering Information

XC6219 ①②③④⑤⑥

DESIGNATOR	DESCRIPTION	SYMBOL	DESCRIPTION
①	CE Pin Logic	A	: High Active (ull-down resistor built in)
		B	: High Active (no pull-down resistor built in)
		C	: Low Active (pull-up resistor built in)
		D	: Low Active (no pull-up resistor built in)
② ③	Output Voltage	09 ~ 50	: e.g. ②=3, ③=0, ⇨ 3.0V
④	Output Voltage, 100mV increments, ±2% accuracy	2	: e.g. ②=2, ③=8, ④=2 ⇨ 2.80V, ±2%
	Output Voltage, 50mV increments, ±2% accuracy	A	: e.g. ②=2, ③=8, ④=A ⇨ 2.85V, ±2%
⑤	Packages	M	: SOT-25 (SOT-23-5)
		P	: SOT-89-5
		D	: USP-6B
⑥	Taping Direction	R	: Embossed tape, Standard feed
		L	: Embossed tape, Reverse feed

XC6219 Series

High Speed LDO Regulators, Low ESR Cap. Compatible, ON/OFF Switch



PACKAGING INFORMATION

○ SOT-25 (SOT-23-5)

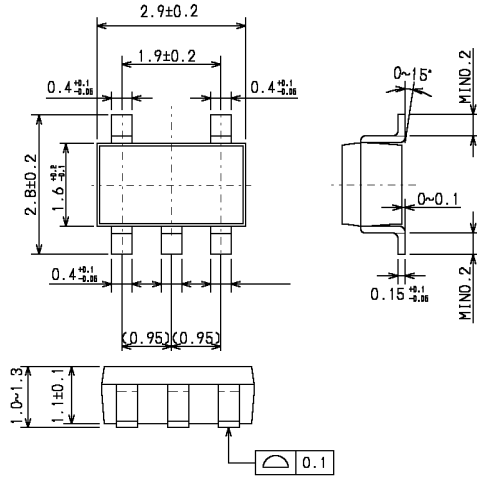

○ SOT-89-5

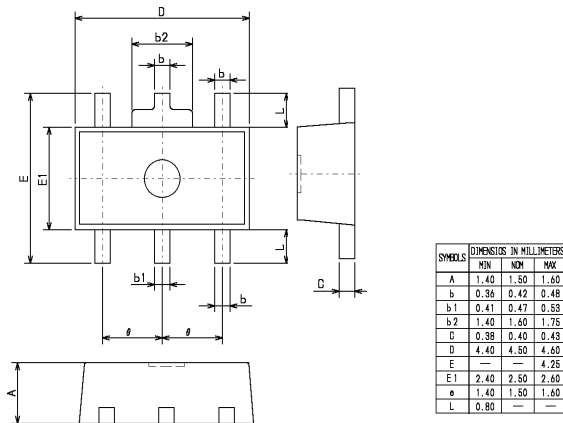

○ USP-6B

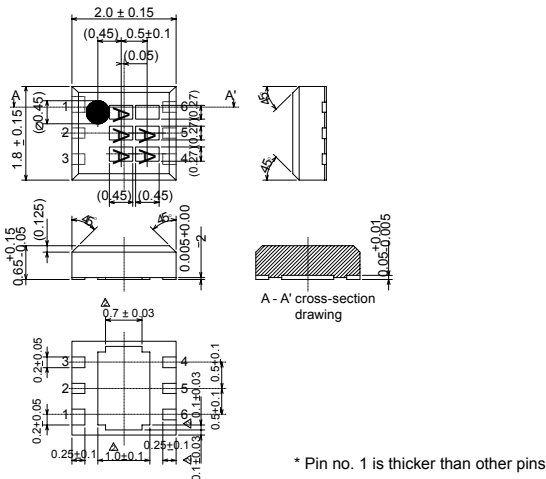

XC6219 Series

High Speed LDO Regulators, Low ESR Cap. Compatible, ON/OFF Switch



MARKING RULE

○ SOT-25 (SOT-23-5)

① Represents product series

MARK	PRODUCT SERIES
L	XC6219xxxxMx

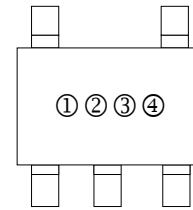

SOT-25 (TOP VIEW)

② Represents type of regulator

MARK				PRODUCT SERIES
VOUT 100mV STEPS		VOUT 50mV STEPS		
VOUT:0.1~3.0V	VOUT:3.1~6.0V	VOUT:0.15~3.05V	VOUT:3.15~6.05V	
V	A	E	L	XC6219AxxxMx
X	B	F	M	XC6219BxxxMx
Y	C	H	N	XC6219CxxxMx
Z	D	K	P	XC6219DxxxMx

③ Represents output voltage

MARK	OUTPUT VOLTAGE				MARK	OUTPUT VOLTAGE			
0	-	3.1	-	3.15	F	1.6	4.6	1.65	4.65
1	-	3.2	-	3.25	H	1.7	4.7	1.75	4.75
2	-	3.3	-	3.35	K	1.8	4.8	1.85	4.85
3	-	3.4	-	3.45	L	1.9	4.9	1.95	4.95
4	-	3.5	-	3.55	M	2.0	5.0	2.05	
5	-	3.6	-	3.65	N	2.1		2.15	
6	-	3.7	-	3.75	P	2.2		2.25	
7	-	3.8	-	3.85	R	2.3		2.35	
8	0.9	3.9	0.95	3.95	S	2.4		2.45	
9	1.0	4.0	1.05	4.05	T	2.5		2.55	
A	1.1	4.1	1.15	4.15	U	2.6		2.65	
B	1.2	4.2	1.25	4.25	V	2.7		2.75	
C	1.3	4.3	1.35	4.35	X	2.8		2.85	
D	1.4	4.4	1.45	4.45	Y	2.9		2.95	
E	1.5	4.5	1.55	4.55	Z	3.0		3.05	

④ Represents production lot number

0 to 9, A to Z, reverse character of 0 to 9, A to Z repeated. (G, I, J, O, Q, W excepted)

XC6219 Series

High Speed LDO Regulators, Low ESR Cap. Compatible, ON/OFF Switch



MARKING RULE (Continued)

○ USP-6B

① ② Represents product series

MARK		PRODUCT SERIES
①	②	
L		XC6219xxxxDx

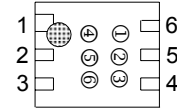

USP-6B (TOP VIEW)

③ Represents type of regulator

MAKR	TYPE	PRODUCT SERIES
A	High Active, Pull-down resistor built-in (semi-custom)	XC6219AxxxMx
B	High Active, Pull-down resistor built-in (semi-custom)	XC6219BxxxMx
C	Low Active, Pull-up resistor built-in (semi-custom)	XC6219CxxxMx
D	Low Active, Pull-up resistor built-in (semi-custom)	XC6219DxxxMx

④ Represents product series

MARK	VOLTAGE	PRODUCT SERIES
3	3.X	XC6219x3xxDx
5	5.X	XC6219x5xxDx

③ Represents output voltage

MARK	VOLTAGE	PRODUCT SERIES	MARK	VOLTAGE	PRODUCT SERIES
0	X.0	XC6219xx0xDx	A	X.05	XC6219xx0ADx
1	X.1	XC6219xx1xDx	B	X.15	XC6219xx1ADx
2	X.2	XC6219xx2xDx	C	X.25	XC6219xx2ADx
3	X.3	XC6219xx3xDx	D	X.35	XC6219xx3ADx
4	X.4	XC6219xx4xDx	E	X.45	XC6219xx4ADx
5	X.5	XC6219xx5xDx	F	X.55	XC6219xx5ADx
6	X.6	XC6219xx6xDx	H	X.65	XC6219xx6ADx
7	X.7	XC6219xx7xDx	K	X.75	XC6219xx7ADx
8	X.8	XC6219xx8xDx	L	X.85	XC6219xx8ADx
9	X.9	XC6219xx9xDx	M	X.95	XC6219xx9ADx

④ Represents production lot number

0 to 9, A to Z repeated. (G, I, J, O, Q, W excepted)

* No character inversion used.

XC6219 Series

High Speed LDO Regulators, Low ESR Cap. Compatible, ON/OFF Switch



■ BLOCK DIAGRAM

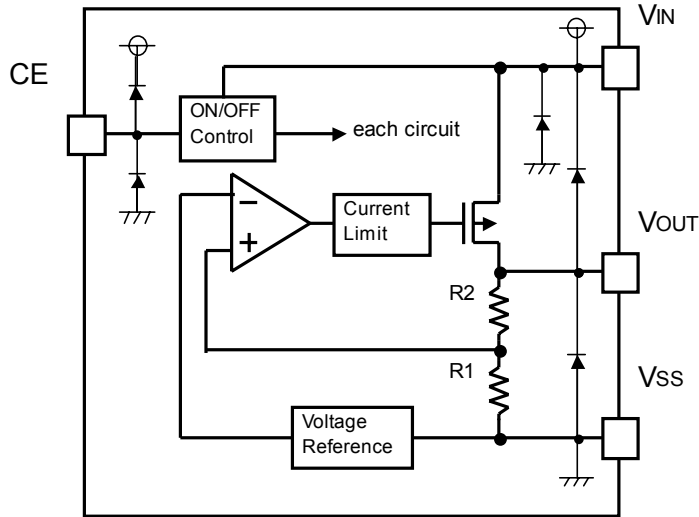

■ ABSOLUTE MAXIMUM RATINGS

Ta=25°C

PARAMETER	SYMBOL	RATINGS	UNITS
Input Voltage	VIN	7.0	V
Output Current	IOUT	500	mA
Output Voltage	VOUT	VSS - 0.3 ~ VIN + 0.3	V
CE Pin Voltage	VCE	VSS - 0.3 ~ VIN + 0.3	V
Power Dissipation	SOT-25	250	mW
	SOT-89	500	
	USP-6B	100	
Operating Temperature Range	Topr	- 40 ~ + 85	°C
Storage Temperature Range	Tstg	- 55 ~ + 125	°C

XC6219 Series

High Speed LDO Regulators, Low ESR Cap. Compatible, ON/OFF Switch



ELECTRICAL CHARACTERISTICS

○ XC6219B series

Ta=25°C

PARAMETER	SYMBOL	CONDITIONS	MAX.	TYP.	MIN.	UNITS	CIRCUIT
Output Voltage	VOUT(E)	IOUT=30mA	x 0.98	VOUT(T)	x 1.02	V	①
Maximum Output Current	IOUTMAX		150	-	-	mA	①
Load Regulation	ΔV_{OUT}	1mA ≤ IOUT ≤ 100mA	-	15	50	mV	①
Dropout Voltage	Vdif1	IOUT=30mA	E-1			mV	①
	Vdif2	IOUT=100mA	E-2			mV	
Supply Current	IDD	VCE=VIN	-	25	50	μA	②
Standby Current	Istby	VCE=VSS	-	0.01	0.10	μA	②
Line Regulation	$\frac{\Delta V_{OUT}}{\Delta V_{IN} \cdot V_{OUT}}$	VOUT(T)+1.0V ≤ VIN ≤ 7.0V IOUT=30mA	-	0.01	0.20	%/V	①
Input Voltage	VIN		2.0		6.0	V	-
Output Voltage Temperature Characteristics	$\frac{\Delta V_{OUT}}{\Delta T_{opr} \cdot V_{OUT}}$	IOUT=30mA -40°C ≤ Topr ≤ 85°C	-	100	-	ppm/°C	①
Ripple Rejection Rate	PSRR	IOUT=50mA, f=10kHz	-	65	-	dB	④
Current Limiter	Ilim		-	300	-	mA	①
Short Circuit Current	Ishort		-	50	-	mA	①
EN 'High' Voltage	VCEH		1.60		VIN	V	①
EN 'Low' Voltage	VCEL				0.25	V	②
EN 'High' Current	ICEH	VCE=VIN	-0.10		0.10	μA	②
EN 'Low' Current	ICEL	VCE=VSS	-0.10		0.10	μA	②

NOTE:

*1: VOUT(T) = Specified output voltage

*2: VOUT(E) = Effective output voltage (I.e. the output voltage when "VOUT(T)+1.0V" is provided at the VIN pin while maintaining a certain IOUT value.)

3: $V_{dif} = \{V_{IN1}^{()} - V_{OUT1}^{(*)}\}$

*4: VOUT=A voltage equal to 98% of the output voltage whenever an amply stabilized IOUT {VOUT(T)+1.0V} is input.

*5: VIN=The Input Voltage when VOUT appears as Input Voltage is gradually decreased.

*6: Unless otherwise stated, VIN=VOUT(T)+1.0V.

DROPOUT VOLTAGE CHART

SYMBOL	E-1			E-2		
	Vdif1			Vdif2		
PARAMETER	MIN.	TYP.	MAX.	MIN.	TYP.	MAX.
OUTPUT VOLTAGE						
0.9	1100	1100	1110	1100	1150	1200
1.50	500	500	510	500	550	600
1.80 ~ 1.85	200	200	210	200	300	400
1.90 ~ 1.95	100	120	150	100	280	380
2.00 ~ 2.05	-	80	120	-	240	350
2.10 ~ 2.25	-	80	120	-	240	330
2.30 ~ 2.45	-	80	120	-	240	310
2.50 ~ 2.75	-	70	100	-	220	290
2.80 ~ 2.95	-	70	100	-	220	270
3.00 ~ 3.05	-	60	90	-	200	270
3.10 ~ 3.95	-	60	90	-	200	250
4.00 ~ 4.95	-	60	80	-	180	230
5.00	-	50	70	-	160	210

* The input voltage 2.0V (MIN) is needed to operate the series.

When the output voltage is less than 2.0V, 2.0V-VOUT(T) of dropout voltage is needed at minimum.

XC6219 Series

High Speed LDO Regulators, Low ESR Cap. Compatible, ON/OFF Switch



TEST CIRCUITS

Circuit ①

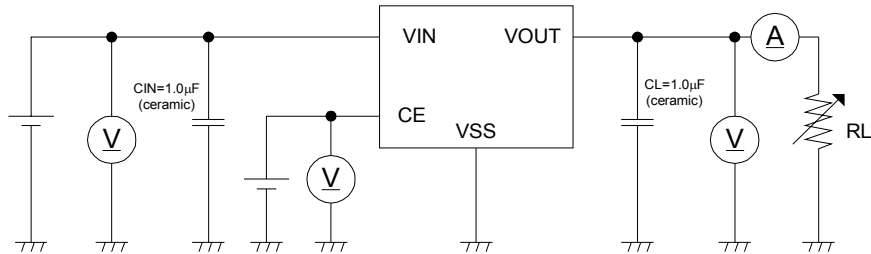

Circuit ②

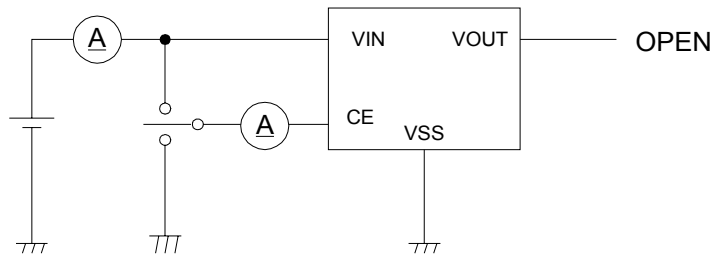

Circuit ③

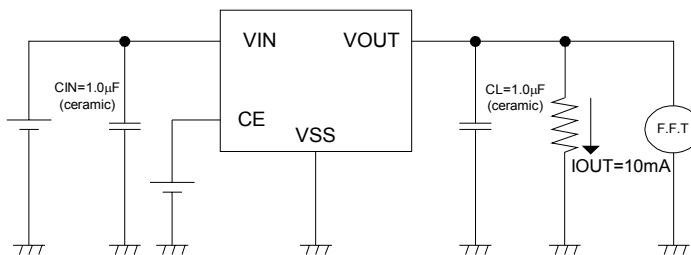

Circuit ④

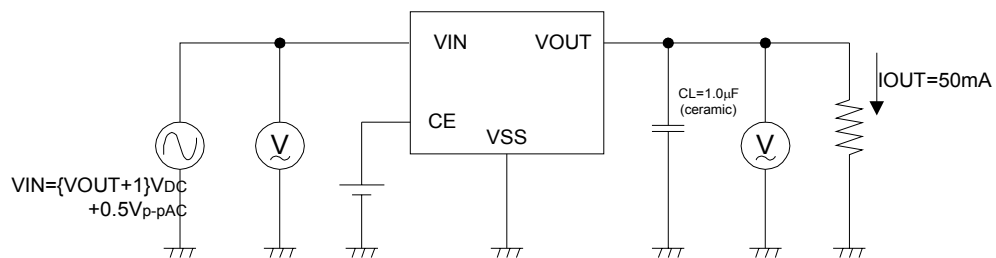

XC6219 Series

High Speed LDO Regulators, Low ESR Cap. Compatible, ON/OFF Switch



■ OPERATIONAL EXPLANATION

<Output Voltage Control>

The voltage divided by resistors R1 & R2 is compared with the internal reference voltage by the error amplifier. The P-channel MOSFET, which is connected to the VOUT pin, is then driven by the subsequent output signal. The output voltage at the VOUT pin is controlled and stabilized by a system of negative feedback. The current limit circuit and short protect circuit operate in relation to the level of output current. Further, the IC's internal circuitry can be shutdown via the CE pin's signal.

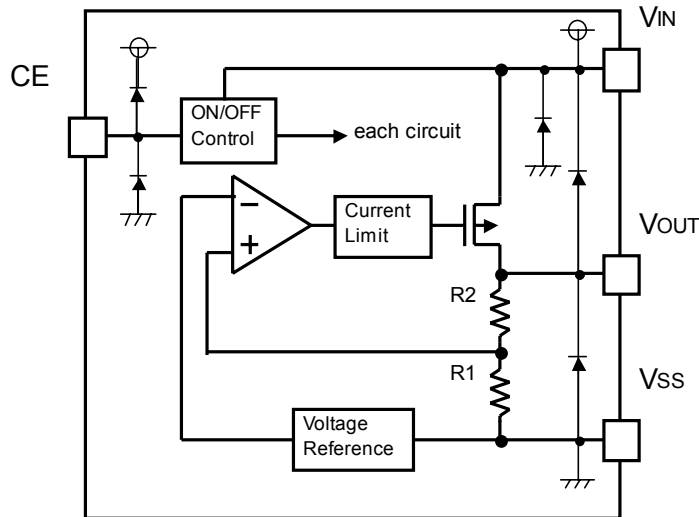

<Low ESR Capacitors>

With the XC6219 series, a stable output voltage is achievable even if used with low ESR capacitors as a phase compensation circuit is built-in. In order to ensure the effectiveness of the phase compensation, we suggest that an output capacitor (CL) is connected as close as possible to the output pin (VOUT) and the VSS pin. Please use an output capacitor with a capacitance value of at least 1 μ F. Also, please connect an input capacitor (CIN) of 0.1 μ F between the VIN pin and the VSS pin in order to ensure a stable power input.

<Current Limiter, Short-Circuit Protection>

The XC6219 series includes a combination of a fixed current limiter circuit & a foldback circuit, which aid the operations of the current limiter and circuit protection. When the load current reaches the current limit level, the fixed current limiter circuit operates and output voltage drops. As a result of this drop in output voltage, the foldback circuit operates, output voltage drops further and output current decreases. When the output pin is shorted, a current of about 50mA flows.

<CE Pin>

The IC's internal circuitry can be shutdown via the signal from the CE pin with the XC6219 series. In shutdown mode, output at the VOUT pin will be pulled down to the VSS level via R1 & R2. The operational logic of the IC's CE pin is selectable (please refer to the selection guide on page 2). Note that as the standard XC6219B type's regulator 1 and 2 are both 'High Active/No Pull Down', operations will become unstable with the CE pin open. Although the CE pin is equal to an inverter input with CMOS hysteresis, with either the pull-up or pull-down options, the CE pin input current will increase when the IC is in operation. We suggest that you use this IC with either a VIN voltage or a VSS voltage input at the CE pin. If this IC is used with the correct specifications for the CE pin, the operational logic is fixed and the IC will operate normally. However, supply current may increase as a result of through current in the IC's internal circuitry.

■ NOTES ON USE

1. Please use this IC within the stated absolute maximum ratings. The IC is liable to malfunction should the ratings be exceeded.
2. Where wiring impedance is high, operations may become unstable due to noise and/or phase lag depending on output current. Please keep the resistance low between VIN and VSS wiring in particular.
3. Please wire the input capacitor (CIN) and the output capacitor (CL) as close to the IC as possible.

XC6219 Series

High Speed LDO Regulators, Low ESR Cap. Compatible, ON/OFF Switch



ELECTRICAL CHARACTERISTICS

(1) Output Voltage vs. Output Current

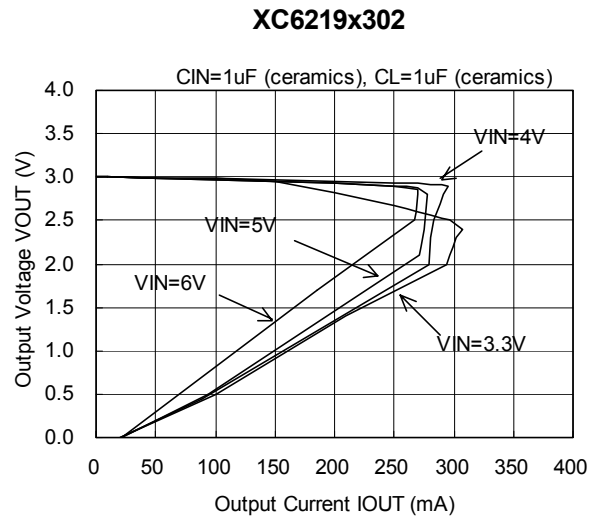
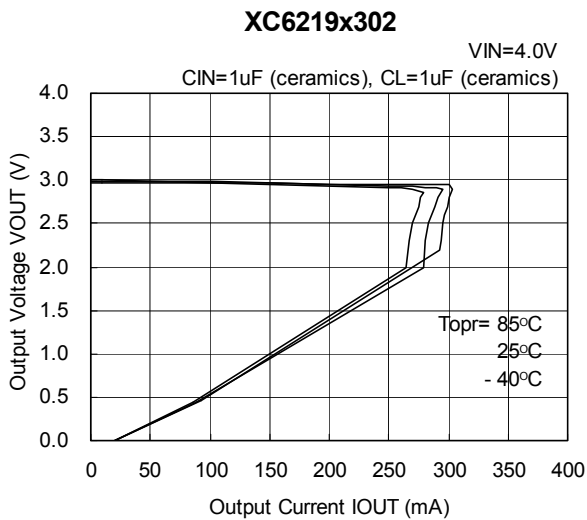
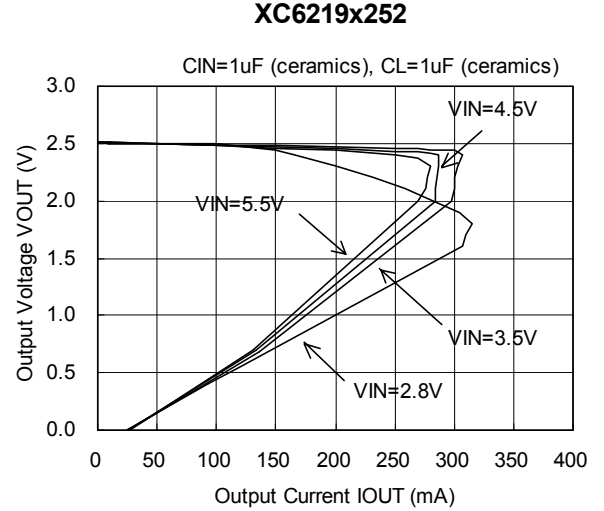
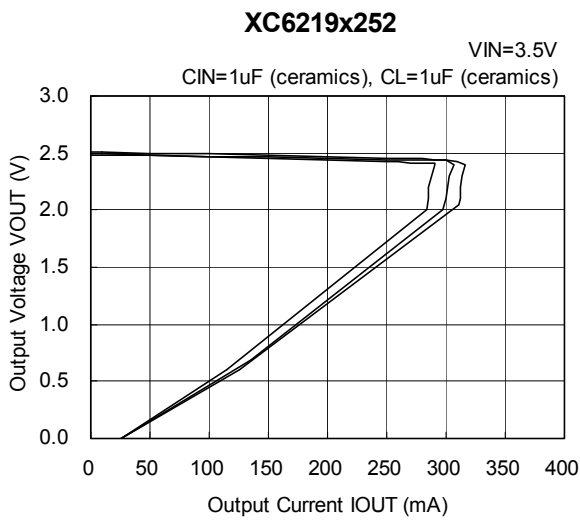
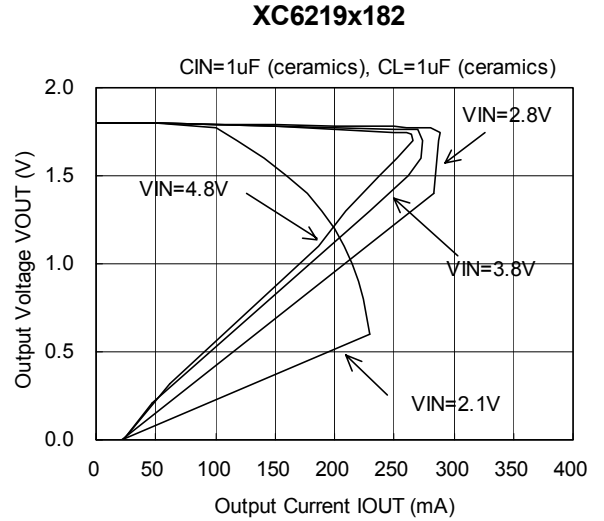
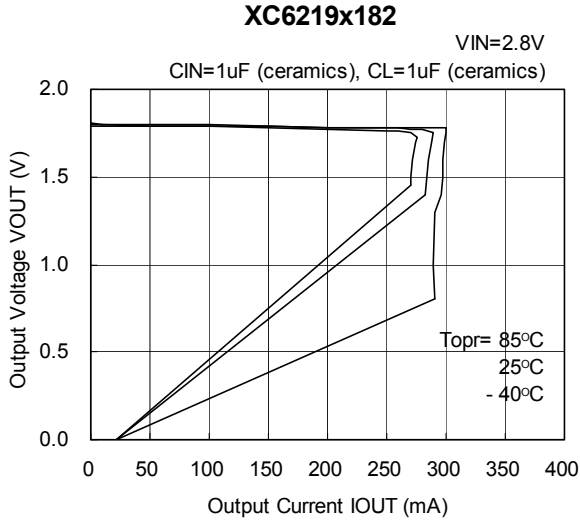

XC6219 Series

High Speed LDO Regulators, Low ESR Cap. Compatible, ON/OFF Switch



■ ELECTRICAL CHARACTERISTICS (Continued)

(2) Output Voltage vs. Input Voltage

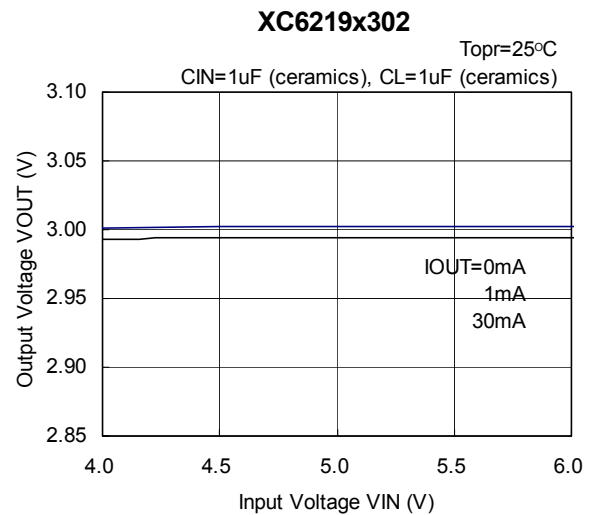
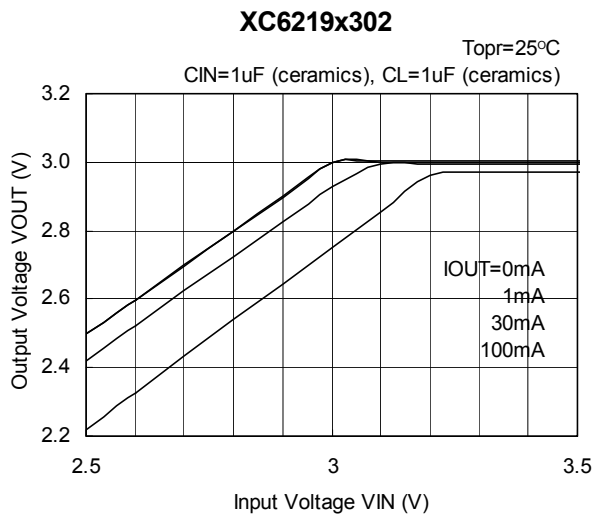
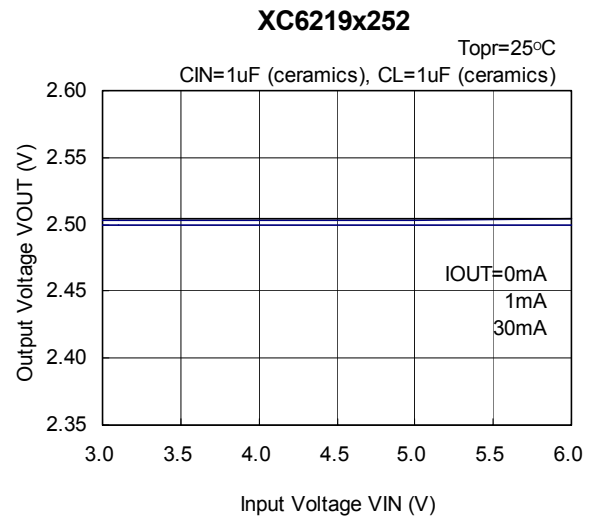
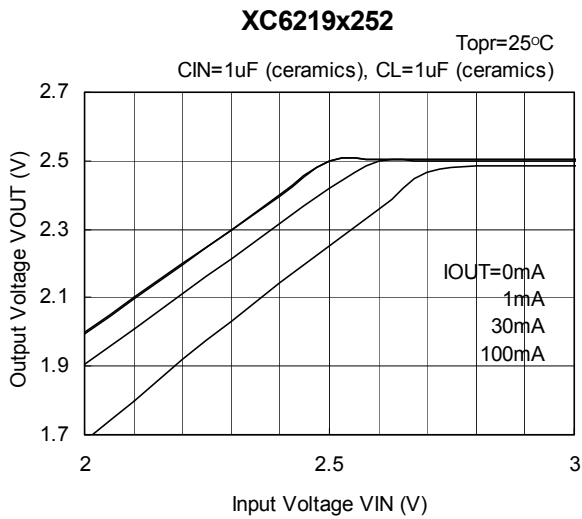
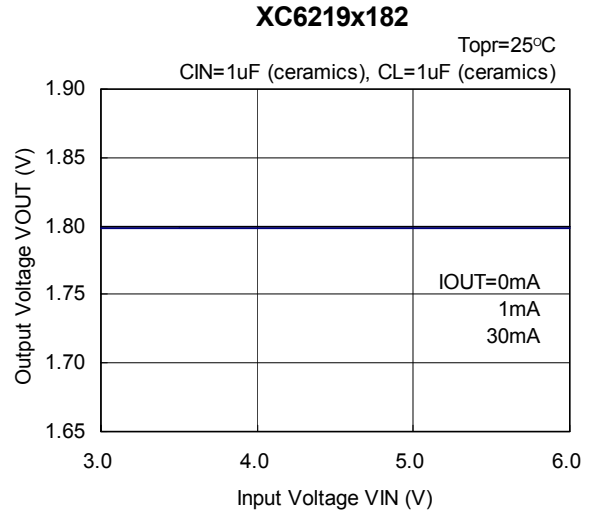
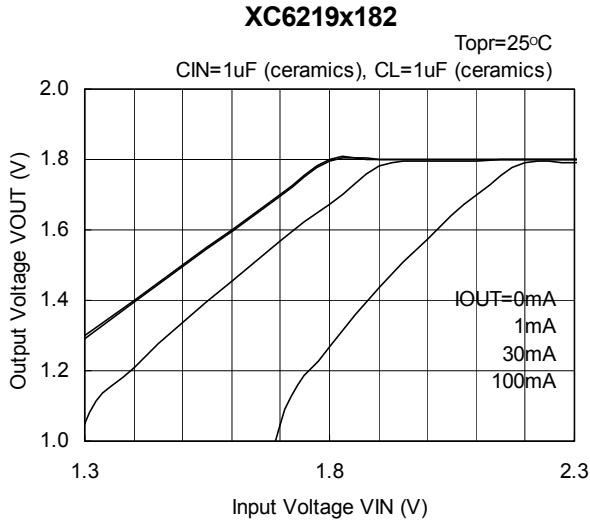

XC6219 Series

High Speed LDO Regulators, Low ESR Cap. Compatible, ON/OFF Switch



■ ELECTRICAL CHARACTERISTICS (Continued)

(3) Dropout Voltage vs. Output Current

XC6219x182

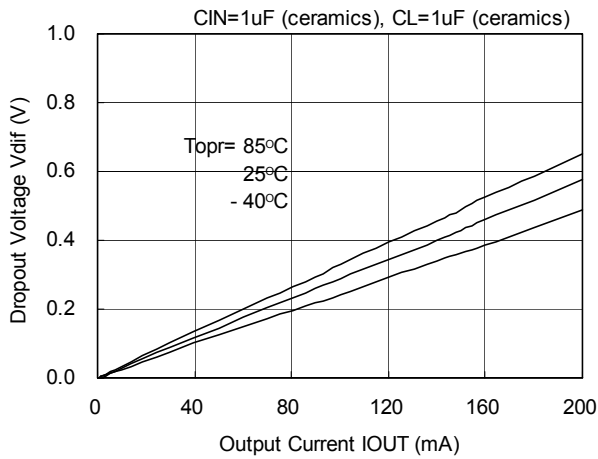

XC6219x252

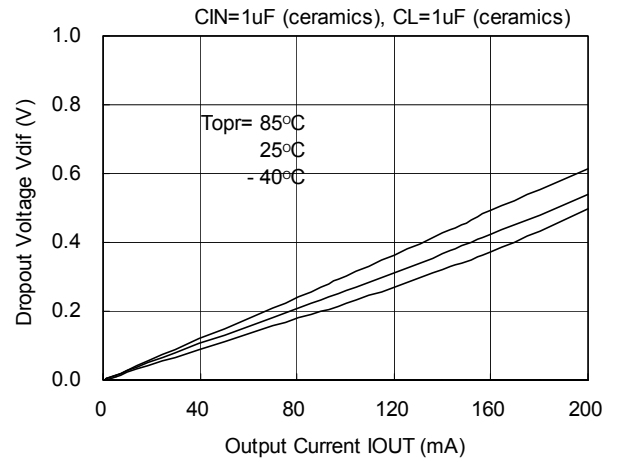

XC6219x302

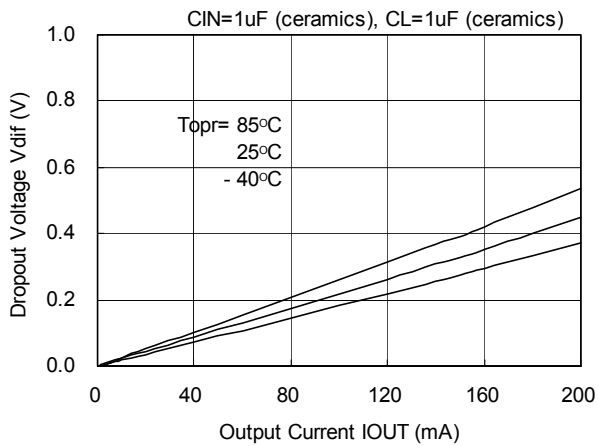

(4) Supply Current vs. Input Voltage

XC6219x182

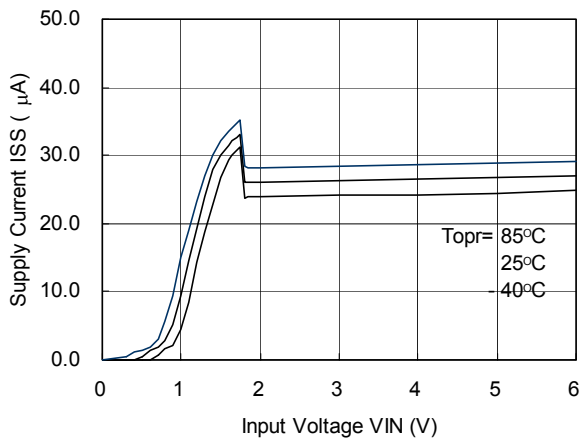

XC6219x252

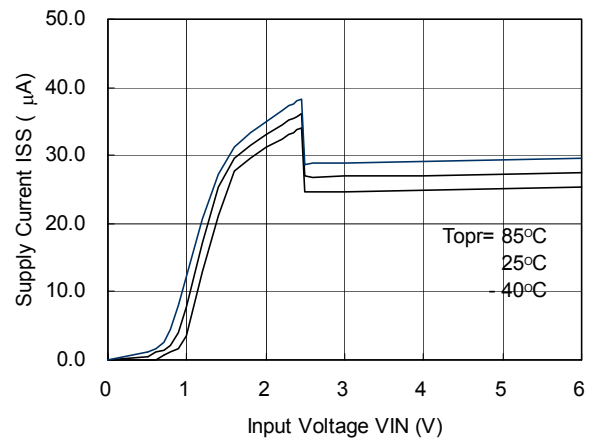

XC6219 Series

High Speed LDO Regulators, Low ESR Cap. Compatible, ON/OFF Switch



■ ELECTRICAL CHARACTERISTICS (Continued)

(4) Supply Current vs. Input Voltage (Continued)

XC6210x302

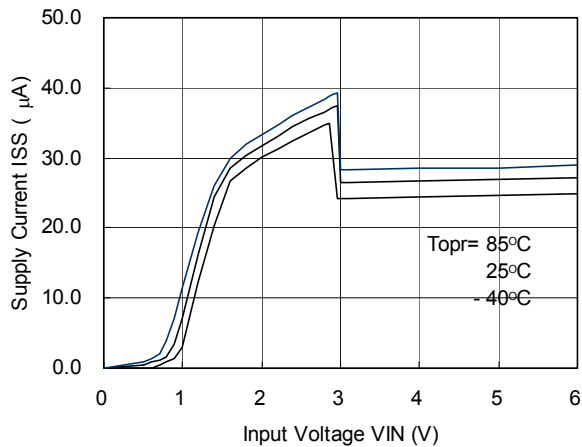

(5) Output Voltage vs. Ambient Temperature

XC6219x182

VIN=2.8V

CIN=1µF (ceramics), CL=1µF (ceramics)

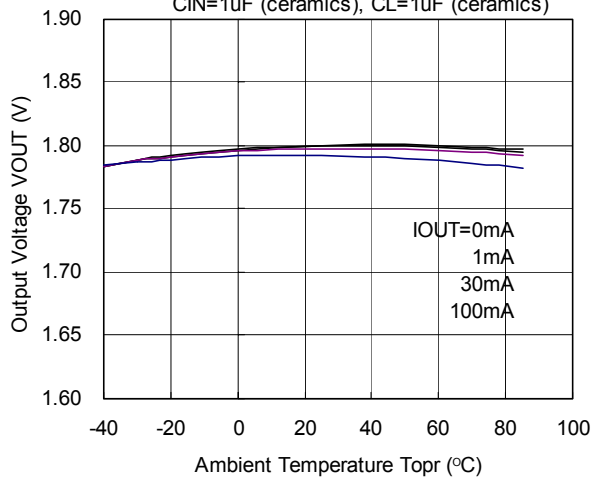

XC6219x252

VIN=3.5V

CIN=1µF (ceramics), CL=1µF (ceramics)

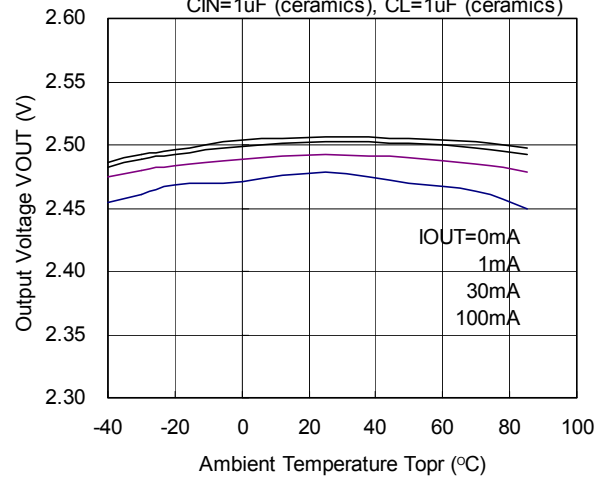

XC6219x302

VIN=4.0V

CIN=1µF (ceramics), CL=1µF (ceramics)

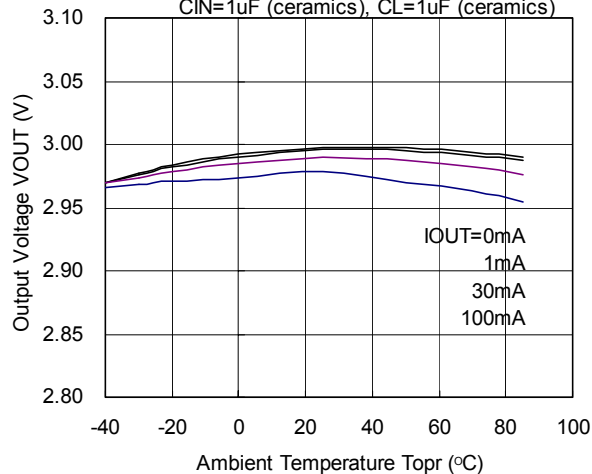

XC6219 Series

High Speed LDO Regulators, Low ESR Cap. Compatible, ON/OFF Switch



■ ELECTRICAL CHARACTERISTICS (Continued)

(6) Supply Current vs. Ambient Temperature

XC6219x182

VIN=2.8V

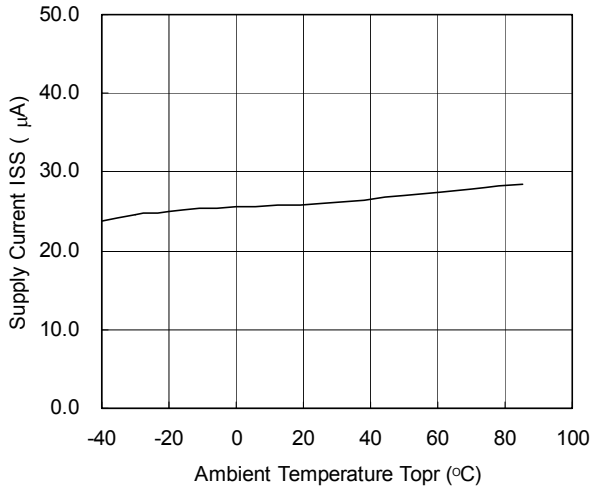

XC6219x252

VIN=3.5V

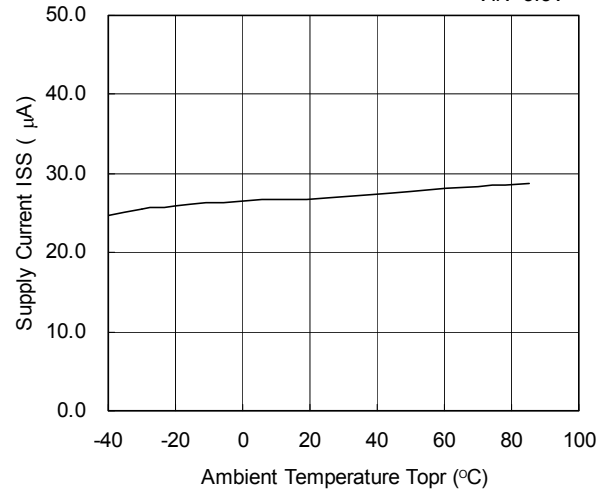

XC6219x302

VIN=4.0V

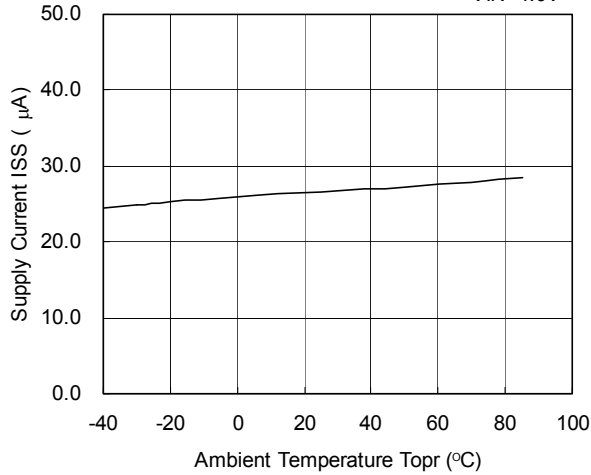

XC6219 Series

High Speed LDO Regulators, Low ESR Cap. Compatible, ON/OFF Switch



ELECTRICAL CHARACTERISTICS (Continued)

(7) Input Transient Response

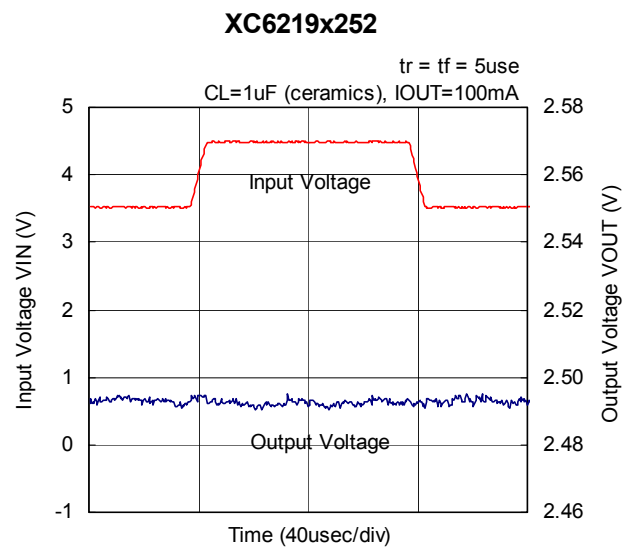
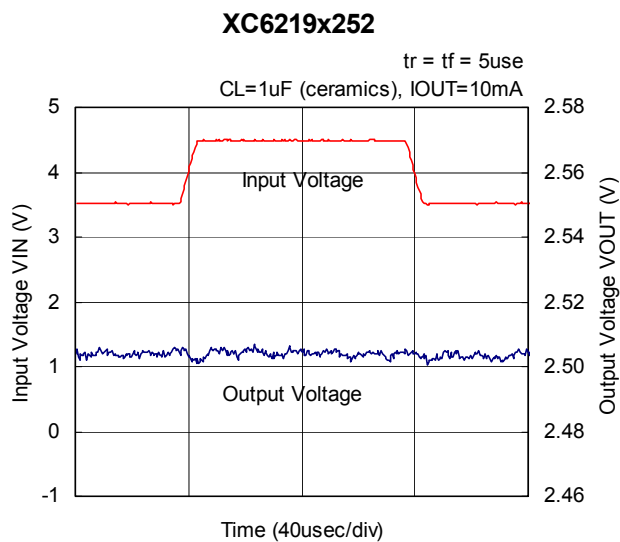
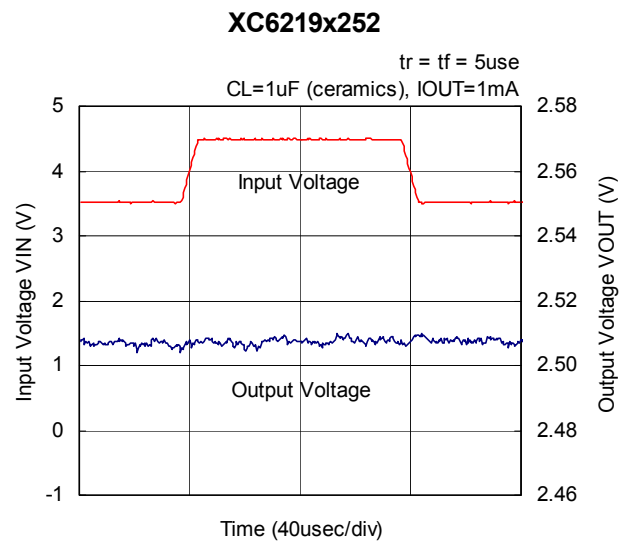
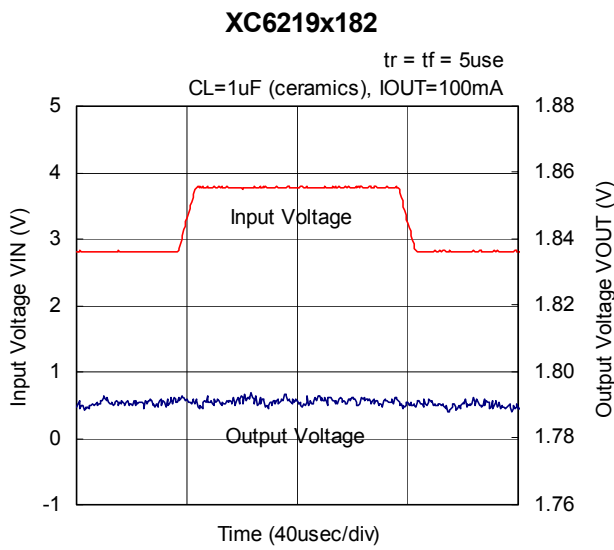
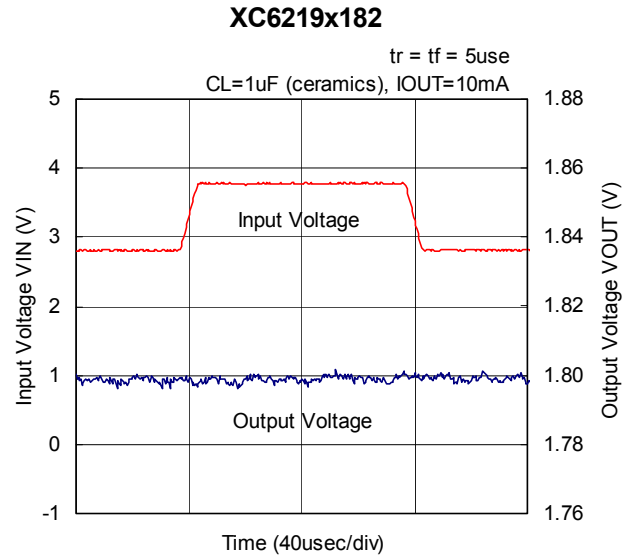
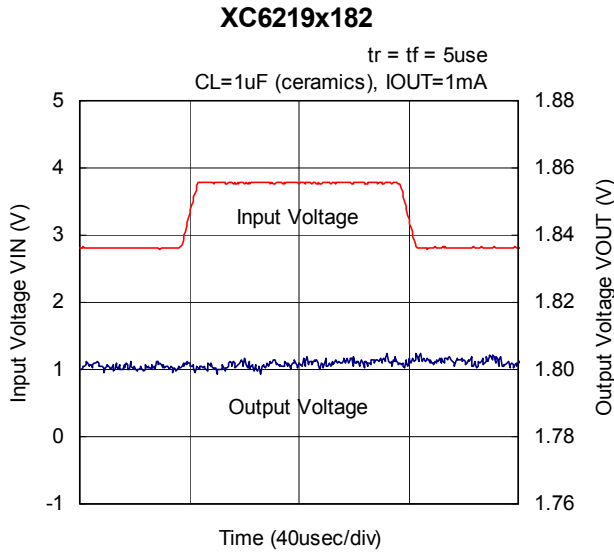

XC6219 Series

High Speed LDO Regulators, Low ESR Cap. Compatible, ON/OFF Switch



■ ELECTRICAL CHARACTERISTICS (Continued)

(7) Input Transient Response (Continued)

XC6219x302

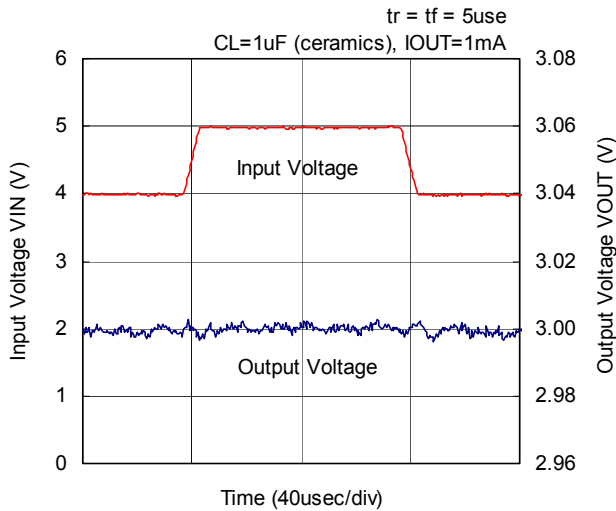

XC6219x302

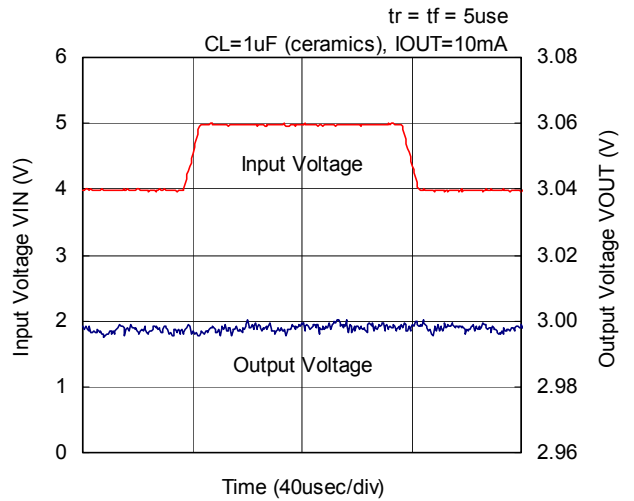

XC6219x302

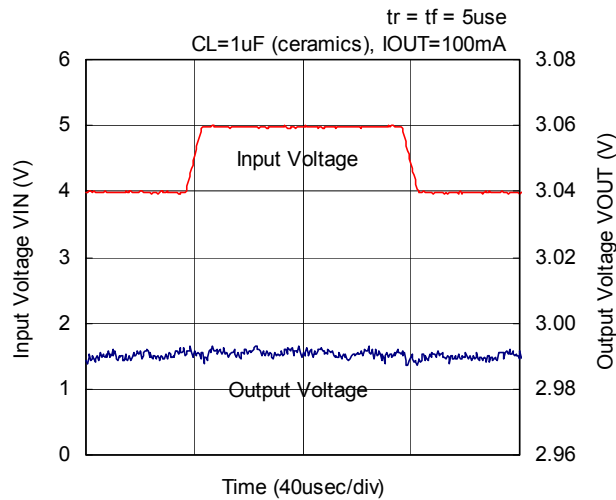

(8) Load Transient Response

XC6219x182

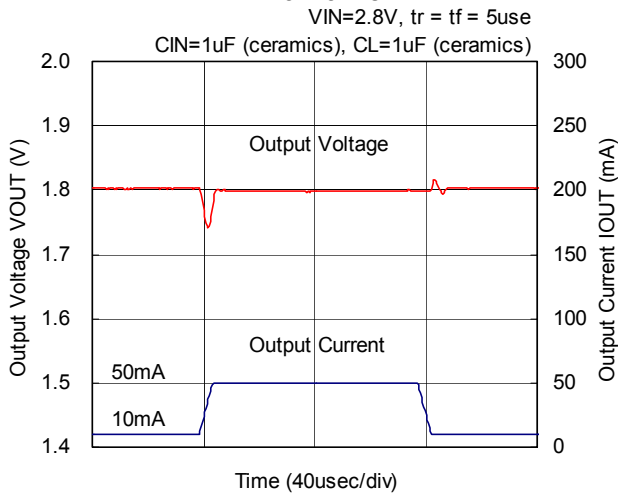

XC6219x182

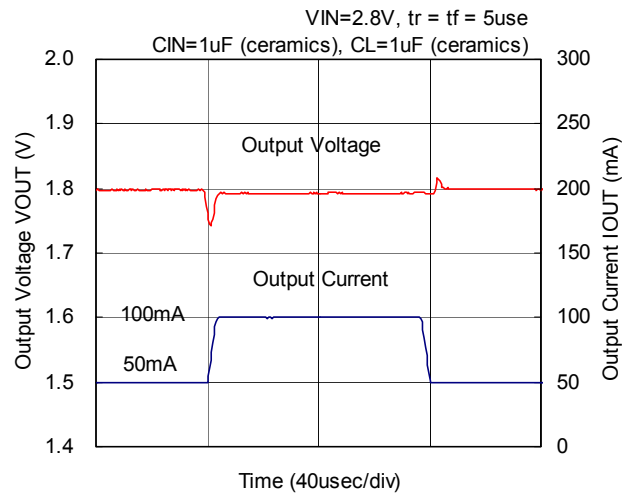

XC6219 Series

High Speed LDO Regulators, Low ESR Cap. Compatible, ON/OFF Switch



ELECTRICAL CHARACTERISTICS (Continued)

(8) Load Transient Response (Continued)

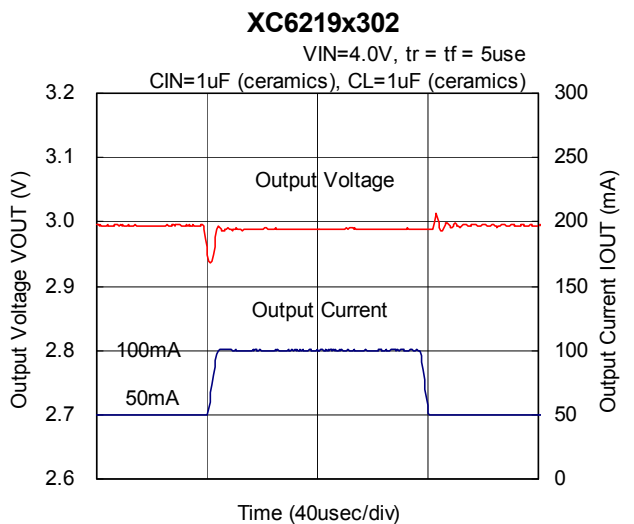
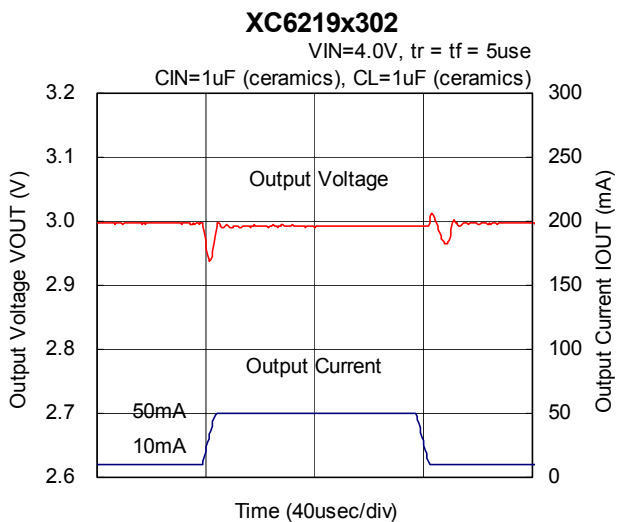
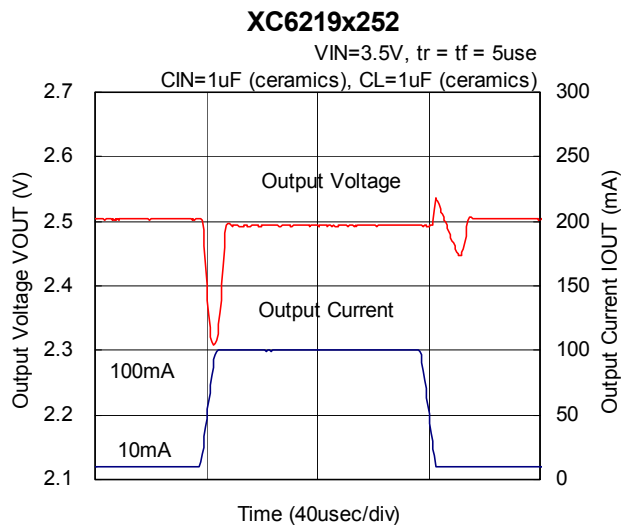
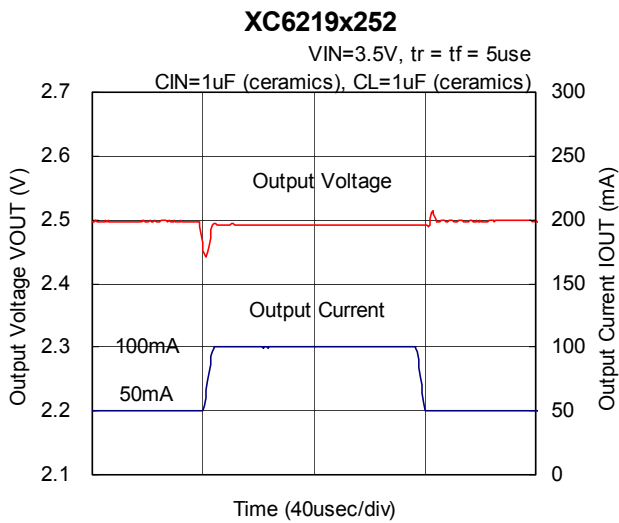
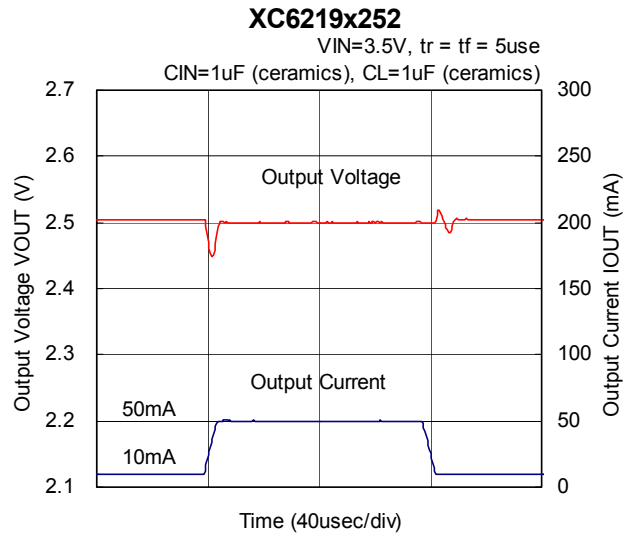
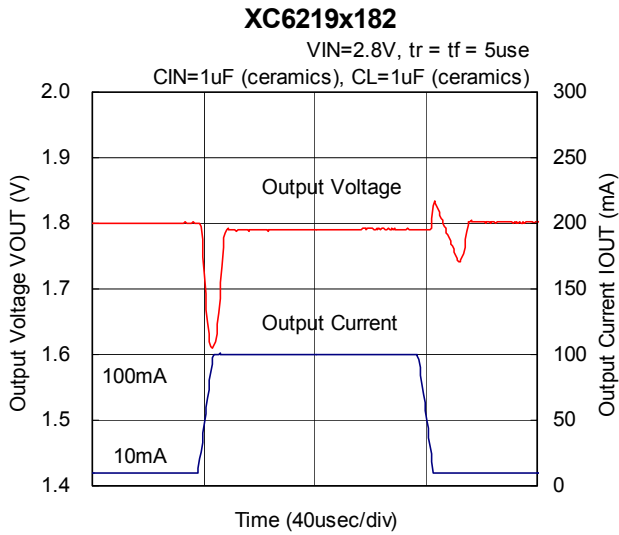

XC6219 Series

High Speed LDO Regulators, Low ESR Cap. Compatible, ON/OFF Switch



■ ELECTRICAL CHARACTERISTICS (Continued)

(8) Load Transient Response (Continued)

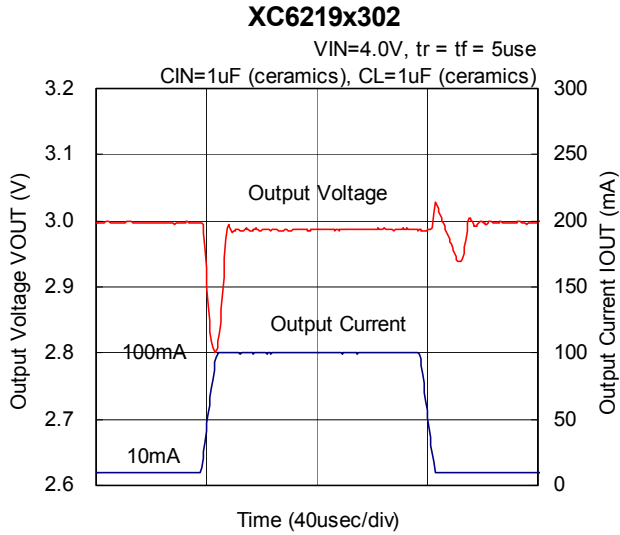

(11) Ripple Rejection Rate

