



10-Ω SPDT Analog Switch

DESCRIPTION

The UTC U7SB3157 is a dual, single-pole, double-throw(SPDT) analog switch or 2:1 multiplexer/de-multiplexer bus switch which can handle both digital and analog signals. This device operates from 1.65V to 5.5V.

FEATURES

- *Useful in Both Analog and Digital Applications
- *Specified Break-Before-Make Switching
- *Low ON-State Resistance: 10Ω
- *Wide Single-Supply Operation: 1.65V to 5.5V

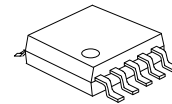

MSOP-10

ORDERING INFORMATION

Ordering Number		Package	Packing
Lead Free	Halogen Free		
U7SB3157L-SM2-R	U7SB3157G-SM2-R	MSOP-10	Tape Reel

<p>U7SB3157L-SM2-R</p> <p>(1) Packing Type (2) Package Type (3) Lead Free</p>	<p>(1) R: Tape Reel (2) SM2: MSOP-10 (3) G: Halogen Free, L: Lead Free</p>
---	--

■ PIN CONFIGURATION

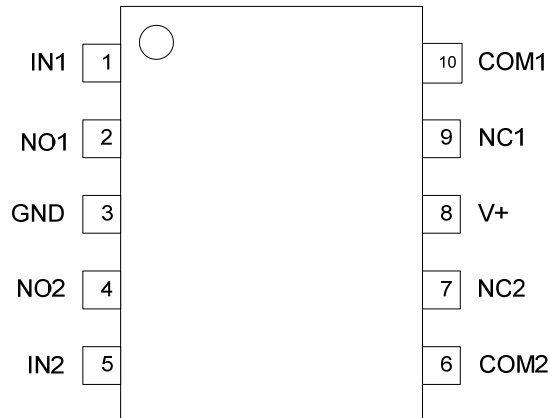

■ FUNCTION TABLE

INPUTS(IN)	FUNCTION
H	NO Connected to COM
L	NC Connected to COM

Note:H: HIGH voltage level; L: LOW voltage level.

■ LOGIC DIAGRAM (each channel)

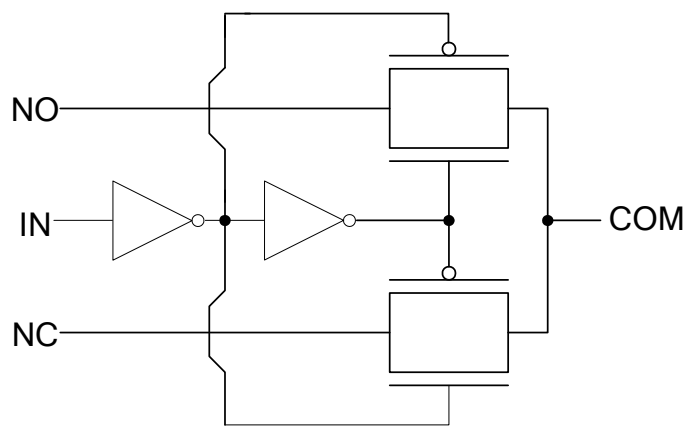

Logic Symbol

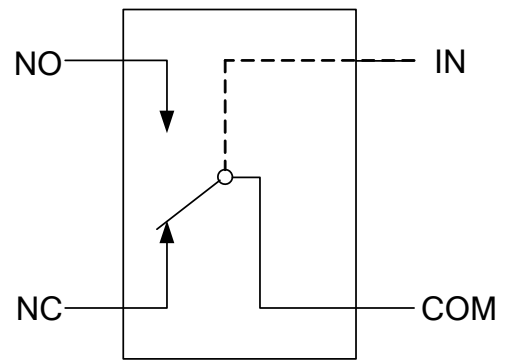

Analog Symbol

■ **ABSOLUTE MAXIMUM RATING** (Ta = 25°C, unless otherwise specified)

PARAMETER	SYMBOL	RATINGS	UNIT
Supply Voltage	V ₊	-0.5 ~ +6.5	V
Analog Voltage (NC, NO, COM)	V _{NC} V _{NO} V _{COM}	-0.5 ~ V ₊ + 0.5V	V
Analog Port Diode Current (V _{NC} V _{NO} V _{COM} < 0 or V _{NC} V _{NO} V _{COM} > V ₊)	I _{I/O} K	±50	mA
On-State Switch Current (V _{NC} V _{NO} V _{COM} = 0 to V ₊)	I _{NC} I _{NO} I _{COM}	±50	mA
Digital Input Voltage	V _{IN}	-0.5 ~ +6.5	V
Digital Input Clamp Current (V _{IN} < 0)	I _{IK}	-50	mA
V ₊ or GND Current	I ₊	±100	mA
Operating Temperature	T _{OPR}	-40 ~ + 85	°C
Storage Temperature	T _{STG}	-65 ~ + 150	°C

Note: Absolute maximum ratings are those values beyond which the device could be permanently damaged. Absolute maximum ratings are stress ratings only and functional device operation is not implied.

■ **OPERATING RATINGS**

PARAMETER	SYMBOL	RATINGS	UNIT
Supply Voltage	V ₊	1.65 ~ 5.5	V
Analog Signal Voltage	V _{NC} V _{NO} V _{COM}	0 ~ V ₊	V

■ **THERMAL DATA**

PARAMETER	SYMBOL	RATINGS	UNIT
Junction to Ambient	θ _{JA}	165	°C/W

■ **ELECTRICAL CHARACTERISTICS**(Ta = 25°C, unless otherwise specified)

PARAMETER	SYMBOL	TEST CONDITIONS		MIN	TYP	MAX	UNIT
ANALOG SWITCH							
Switch On Resistance	R _{ON}	V ₊ =1.65V	V _{NO} or V _{NC} =0~V ₊ , I _{COM} =-4mA			140	Ω
		V ₊ =2.3V	V _{NO} or V _{NC} =0~V ₊ , I _{COM} =-8mA			45	Ω
		V ₊ =3V	V _{NO} or V _{NC} =0~V ₊ , I _{COM} =-24mA			18	Ω
		V ₊ = 4.5V	V _{NO} or V _{NC} =0~V ₊ , I _{COM} =-30mA			10	Ω
On Resistance Match Between Channel	ΔR _{ON}	V ₊ =1.65V	V _{NO} or V _{NC} =1.15V, I _{COM} =-4mA		1		Ω
		V ₊ =2.3V	V _{NO} or V _{NC} =1.6V, I _{COM} =-8mA		0.5		Ω
		V ₊ =3V	V _{NO} or V _{NC} =2.1V, I _{COM} =-24mA		0.2		Ω
		V ₊ = 4.5V	V _{NO} or V _{NC} =3.15V, I _{COM} =-30mA		0.15		Ω
On Resistance Flatness	R _{ON(flat)}	V ₊ =1.65V	V _{NO} or V _{NC} =0~V ₊ , I _{COM} =-4mA		110		Ω
		V ₊ =2.3V	V _{NO} or V _{NC} =0~V ₊ , I _{COM} =-8mA		27		Ω
		V ₊ =3V	V _{NO} or V _{NC} =0~V ₊ , I _{COM} =-24mA		9		Ω
		V ₊ = 4.5V	V _{NO} or V _{NC} =0~V ₊ , I _{COM} =-30mA		4		Ω
NC,NO OFF Leakage Current	I _{NC(OFF)}	V ₊ =1.95V	V _{NO} or V _{NC} =0~V ₊ , V _{COM} =0~V ₊	-1	0.05	1	uA
		V ₊ =2.7V	V _{NO} or V _{NC} =0~V ₊ , V _{COM} =0~V ₊	-1	0.05	1	uA
	I _{NO(OFF)}	V ₊ =3.6V	V _{NO} or V _{NC} =0~V ₊ , V _{COM} =0~V ₊	-1	0.05	1	uA
		V ₊ = 5.5V	V _{NO} or V _{NC} =0~V ₊ , V _{COM} =0~V ₊	-1	0.05	1	uA
NC,NO ON Leakage Current	I _{NC(ON)}	V ₊ =1.95V	V _{NO} or V _{NC} =0~V ₊ , V _{COM} =OPEN	-0.1		0.1	uA
		V ₊ =2.7V	V _{NO} or V _{NC} =0~V ₊ , V _{COM} =OPEN	-0.1		0.1	uA
	I _{NO(ON)}	V ₊ =3.6V	V _{NO} or V _{NC} =0~V ₊ , V _{COM} =OPEN	-0.1		0.1	uA
		V ₊ = 5.5V	V _{NO} or V _{NC} =0~V ₊ , V _{COM} =OPEN	-0.1		0.1	uA
COM ON Leakage Current	I _{COM(ON)}	V ₊ =1.95V	V _{NO} or V _{NC} =OPEN, V _{COM} =0~V ₊	-0.1		0.1	uA
		V ₊ =2.7V	V _{NO} or V _{NC} =OPEN, V _{COM} =0~V ₊	-0.1		0.1	uA
		V ₊ =3.6V	V _{NO} or V _{NC} =OPEN, V _{COM} =0~V ₊	-0.1		0.1	uA
		V ₊ = 5.5V	V _{NO} or V _{NC} =OPEN, V _{COM} =0~V ₊	-0.1		0.1	uA
DIGITAL INPUTS(IN1,IN2)							
Input Logic High	V _{IH}	V ₊ =1.65V~5.5V		0.7V ₊			V
Input Logic Low	V _{IL}	V ₊ =1.65V~5.5V				0.3V ₊	V
Input Leakage Current	I _{IH,IL}	V ₊ =1.65V~5.5V	V _{IN} =5.5V or 0	-1	0.05	1	uA
SUPPLY							
Quiescent Supply Current	I ₊	V ₊ =1.65V~5.5V	V _{IN} = V ₊ or GND			1	μA
Additional Quiescent Supply Current	ΔI ₊	V ₊ =1.65V~5.5V	V _{IN} = V ₊ - 0.6V			500	uA

SWITCHING CHARACTERISTICS ($T_a = 25^\circ\text{C}$, unless otherwise specified)

PARAMETER	SYMBOL	TEST CONDITIONS	MIN	TYP	MAX	UNIT
Turn ON Time	t_{ON}	$V_+ = 1.65 \sim 1.95\text{V}$	$C_L = 50\text{pF}$ $R_L = 500\Omega$	7	24	ns
		$V_+ = 2.3 \sim 2.7\text{V}$		3.5	14	ns
		$V_+ = 3.0 \sim 3.6\text{V}$		2.5	7.6	ns
		$V_+ = 4.5 \sim 5.5\text{V}$		1.7	5.7	ns
Turn OFF Time	t_{OFF}	$V_+ = 1.65 \sim 1.95\text{V}$	$C_L = 50\text{pF}$ $R_L = 500\Omega$	3	13	ns
		$V_+ = 2.3 \sim 2.7\text{V}$		2	7.5	ns
		$V_+ = 3.0 \sim 3.6\text{V}$		1.5	5.3	ns
		$V_+ = 4.5 \sim 5.5\text{V}$		0.8	3.8	ns
Break-Before-Make Time	t_{BBM}	$V_+ = 1.65 \sim 1.95\text{V}$	$C_L = 35\text{pF}$ $R_L = 50\Omega$	0.5		ns
		$V_+ = 2.3 \sim 2.7\text{V}$		0.5		ns
		$V_+ = 3.0 \sim 3.6\text{V}$		0.5		ns
		$V_+ = 4.5 \sim 5.5\text{V}$		0.5		ns
Charge Injection	Q_C	$V_+ = 3.3\text{V}$	$C_L = 0.1\text{nF}$ $R_L = 1\text{M}\Omega$		3	pC
		$V_+ = 5\text{V}$			7	pC
Bandwith	BW	$V_+ = 1.65 \sim 5.5\text{V}$	$R_L = 50\Omega$		220	MHz
OFF Isolation	O_{ISO}	$V_+ = 1.8\text{V}$	$R_L = 50\Omega$ $f = 10\text{MHz}$		-60	dB
		$V_+ = 2.3\text{V}$			-65	dB
		$V_+ = 3\text{V}$			-65	dB
		$V_+ = 4.5\text{V}$			-65	dB
Crosstalk	X_{TALK}	$V_+ = 1.8\text{V}$	$R_L = 50\Omega$ $f = 10\text{MHz}$		-66	dB
		$V_+ = 2.3\text{V}$			-66	dB
		$V_+ = 3\text{V}$			-66	dB
		$V_+ = 4.5\text{V}$			-66	dB
Total Harmonic Distortion	THD	$V_+ = 1.8\text{V}$	$C_L = 50\text{pF}$ $R_L = 600\Omega$ $f = 600\text{Hz} \sim 20\text{kHz}$		0.015	%
		$V_+ = 2.3\text{V}$			0.025	%
		$V_+ = 3\text{V}$			0.015	%
		$V_+ = 4.5\text{V}$			0.01	%

CAPACITANCE CHARACTERISTICS ($T_a = 25^\circ\text{C}$)

PARAMETER	SYMBOL	TEST CONDITIONS	MIN	TYP	MAX	UNIT
NC,NO OFF Capacitance	$C_{NC(OFF)}$ $C_{NO(OFF)}$	$V_+ = 5\text{V}$ V_{NO} or $V_{NC} = V_+$ or GND		5.5		pF
NC,NO ON Capacitance	$C_{NC(ON)}$ $C_{NO(ON)}$	$V_+ = 5\text{V}$ V_{NO} or $V_{NC} = V_+$ or GND		17.5		pF
COM ON Capacitance	$C_{COM(ON)}$	$V_+ = 5\text{V}$ $V_{COM} = V_+$ or GND		17.5		pF
Digital Input Capacitance	C_{IN}	$V_+ = 5\text{V}$ $V_{IN} = V_+$ or GND		2.8		pF

■ TEST CIRCUIT AND WAVEFORMS

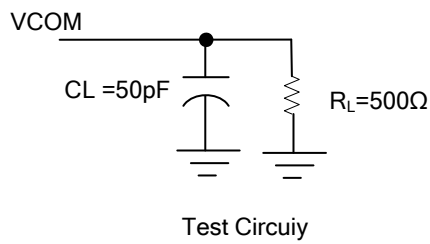

TEST	V _{IN}	V _{NC}	V _{NO}
t _{ON}	L->H	GND	V+
	H->L	V+	GND
t _{OFF}	H->L	GND	V+
	L->H	V+	GND

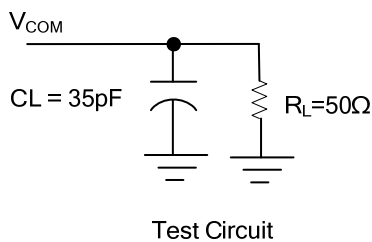
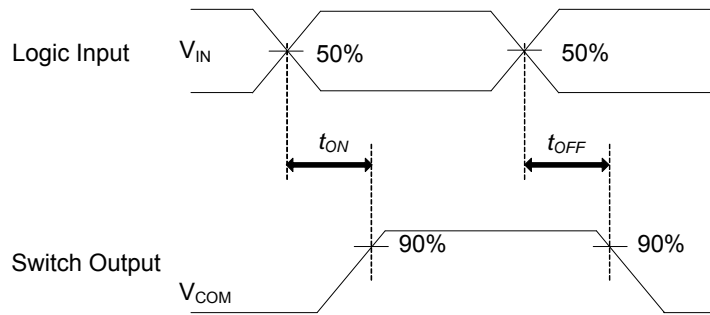

TEST	V _{IN}	V _{NC}	V _{NO}
t _{BBM}	L->H	V+/2	V+/2

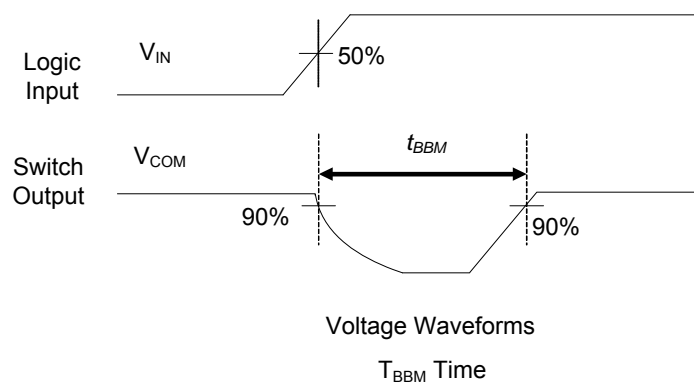

Note: CL includes probe and jig capacitance.
PRR ≤ 1MHz, Z_o = 50Ω, tr ≤ 5ns, tf ≤ 5ns.

UTC assumes no responsibility for equipment failures that result from using products at values that exceed, even momentarily, rated values (such as maximum ratings, operating condition ranges, or other parameters) listed in products specifications of any and all UTC products described or contained herein. UTC products are not designed for use in life support appliances, devices or systems where malfunction of these products can be reasonably expected to result in personal injury. Reproduction in whole or in part is prohibited without the prior written consent of the copyright owner. The information presented in this document does not form part of any quotation or contract, is believed to be accurate and reliable and may be changed without notice.