



## LR1101

CMOS IC

### 100mA, 4μA QUIESCENT CURRENT CMOS LDO REGULATOR

#### DESCRIPTION

The UTC **LR1101** series are ultra-low quiescent current CMOS LDO (Low Dropout Voltage). Designed for battery-powered system, the low 4μA quiescent current makes it an ideal choice. The Range of the output voltage is from 1.5V ~ 5V with 0.1V per step. And the max output current is 100mA.

Wide range of available output fits most of applications. Built-in output current-limiting provide maximal protection against any fault conditions.

#### FEATURES

- \* 450mV typically dropout at 100mA
- \* Ultra-low quiescent current: 4μA
- \* Wide operating voltage ranges: 2V ~ 6V
- \* Thermal current limiting protection
- \* For stability only 1μF output capacitor is required
- \* High power supply rejection ratio

#### ORDERING INFORMATION

Ordering Number	Package	Pin Assignment					Packing
		1	2	3	4	5	
LR1101G-xx-AB3-C-R	SOT-89	G	I	O	-	-	Tape Reel
LR1101G-xx-AE3-5-R	SOT-23	G	O	I	-	-	Tape Reel
LR1101G-xx-AF5-R	SOT-25	I	G	$\overline{EN}$	NC	O	Tape Reel

Note: Pin Assignment: I: V<sub>IN</sub> O: V<sub>OUT</sub> G: GND NC: No Connection  $\overline{EN}$  : Enable

<p>LR1101G-xx-AB3-C-R</p> <p>(1) Packing Type  (2) Pin Assignment  (3) Package Type  (4) Output Voltage Code  (5) Green Package</p>	<p>(1) R: Tape Reel  (2) refer to Pin Assignment  (3) AB3: SOT-89, AE3: SOT-23, AF5: SOT-25  (4) xx: refer to Marking Information  (5) G: Halogen Free and Lead Free</p>
---	--

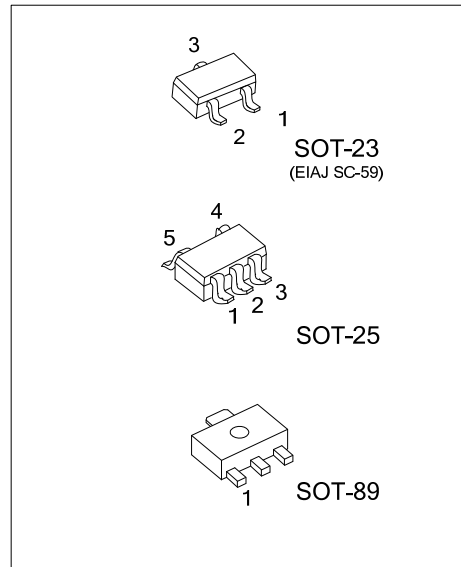

## MARKING INFORMATIONS

PACKAGE	VOLTAGE CODE	PIN CODE	1	2	3	4	5	MARKING
SOT-89	15:1.5V 18:1.8V 25:2.5V 28:2.8V 30:3.0V 33:3.3V 35:3.5V 36:3.6V 47:4.7V 50:5.0V	C	G	I	O	-	-	
SOT-25		-	I	G	$\overline{\text{EN}}$	NC	O	
SOT-23		5	G	O	I	-	-	

## PIN DESCRIPTION

PIN NO.			PIN NAME	DESCRIPTION
SOT-89	SOT-25	SOT-23		
2	1	3	$V_{\text{IN}}$	Input voltage
3	5	2	$V_{\text{OUT}}$	Output voltage
1	2	1	GND	Ground
-	3	-	$\overline{\text{EN}}$	Chip enable input
-	4	-	NC	No connection

## BLOCK DIAGRAM

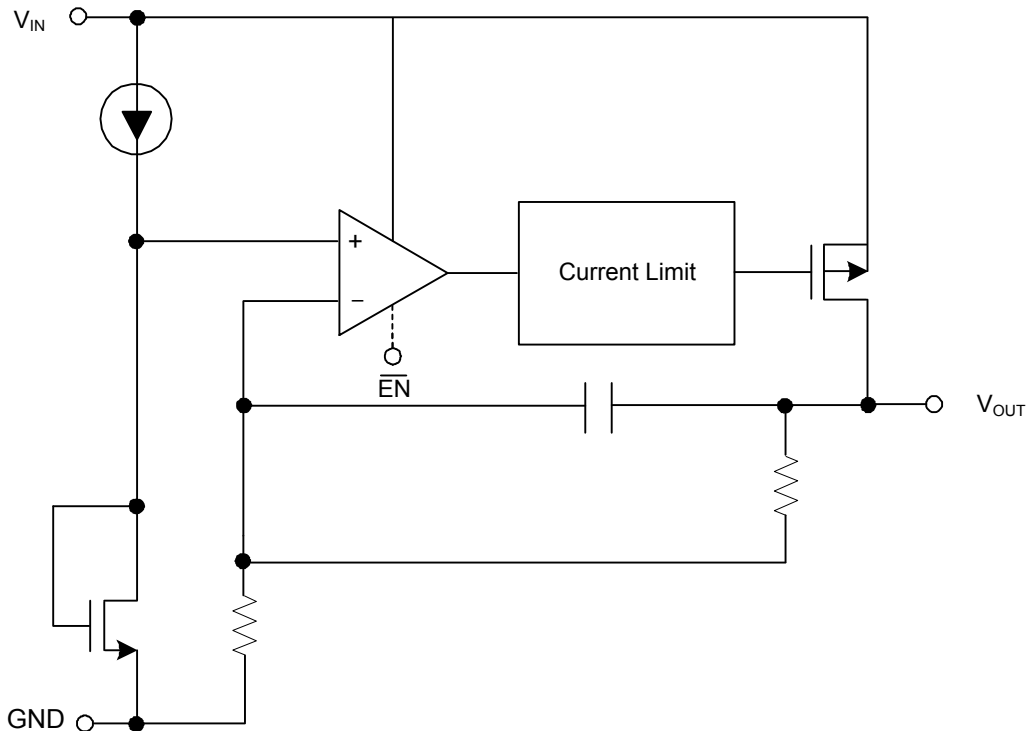

### ■ ABSOLUTE MAXIMUM RATINGS

PARAMETER	SYMBOL	RATINGS	UNIT
Input Voltage	$V_{IN}$	7	V
Power Dissipation ( $T_A = 25^\circ\text{C}$ )	SOT-89	500	mW
	SOT-23	250	mW
	SOT-25	250	mW
Junction Temperature	$T_J$	125	$^\circ\text{C}$
Operating Temperature	$T_{OPR}$	-40 ~ +85	$^\circ\text{C}$
Storage Temperature	$T_{STG}$	-65 ~ +150	$^\circ\text{C}$

Note: Absolute maximum ratings are those values beyond which the device could be permanently damaged. Absolute maximum ratings are stress ratings only and functional device operation is not implied.

### ■ THERMAL DATA

PARAMETER	SYMBOL	RATINGS	UNIT
Thermal Resistance	SOT-89	180	$^\circ\text{C}/\text{W}$
	SOT-23	250	$^\circ\text{C}/\text{W}$
	SOT-25	250	$^\circ\text{C}/\text{W}$

### ■ ELECTRICAL CHARACTERISTICS ( $V_{IN}=5.5\text{V}$ , $C_1=1\mu\text{F}$ , $C_o=1\mu\text{F}$ , $T_A=25^\circ\text{C}$ , unless otherwise specified)

PARAMETER	SYMBOL	TEST CONDITIONS	MIN.	TYP.	MAX.	UNIT
Input Voltage Range	$V_{IN}$		2		6	V
Output Voltage Accuracy	$\Delta V_{OUT}$	$I_L = 1\text{mA}$	-2		+2	%
Line Regulation	$\Delta V_{LINE}$	$V_{IN} = (V_{OUT} + 0.3\text{V})$ to 6V, $V_{IN} \geq 3.6\text{V}$ , $I_{OUT} = 1\text{mA}$	-0.2		0.2	%/V
Load Regulation	$\Delta V_{LOAD}$	$I_{OUT} = 0\text{mA}$ to 100mA		0.01	0.04	%/mA
Maximum Output Current	$I_{MAX}$	$V_{IN} = V_{OUT} + 0.6\text{V}$ , $V_{IN} \geq 3.6\text{V}$	100			mA
Current Limit	$I_{LIMIT}$	$I_L = 100\text{mA}$	150	250		mA
GND Pin Current	$I_G$	No Load		4	7	$\mu\text{A}$
		$I_{OUT} = 100\text{mA}$		4	10	
Dropout Voltage	$V_D$	$I_{OUT} = 1\text{mA}$ , $V_{IN} \geq 3.6\text{V}$		4	10	mV
		$I_{OUT} = 50\text{mA}$ , $V_{IN} \geq 3.6\text{V}$		200	300	
		$I_{OUT} = 100\text{mA}$ , $V_{IN} \geq 3.6\text{V}$		450	600	
Stand By Current	$I_{STN-BY}$	$\overline{EN} = V_{IN}$		0.1	1	$\mu\text{A}$
$\overline{EN}$ Threshold	$\overline{EN}$	$V_{OUT} = \text{High}$	0		0.6	V
		$V_{OUT} = \text{Low}$	2		$V_{IN}$	
Short Current	$I_{SC}$	$V_{OUT} = 0$			650	mA
Thermal Shutdown		Exterior Calefaction	125			$^\circ\text{C}$

## ■ APPLICATION INFORMATION

Between  $V_{OUT}$  and GND a  $1\mu\text{F}$  (or larger) capacitor is recommended for stability. Without the capacitor the part may oscillate. When operating below  $-25^{\circ}\text{C}$  any type of capacitor can be used, but not Aluminum electrolytes. If there's no limit the capacitance may be increased.

Between  $V_{IN}$  to GND a  $1\mu\text{F}$  capacitor (or larger) should be placed.

## ■ APPLICATION CIRCUIT

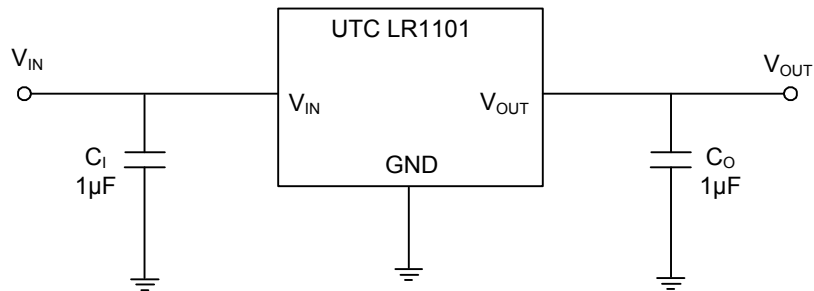

## TYPICAL CHARACTERISTICS

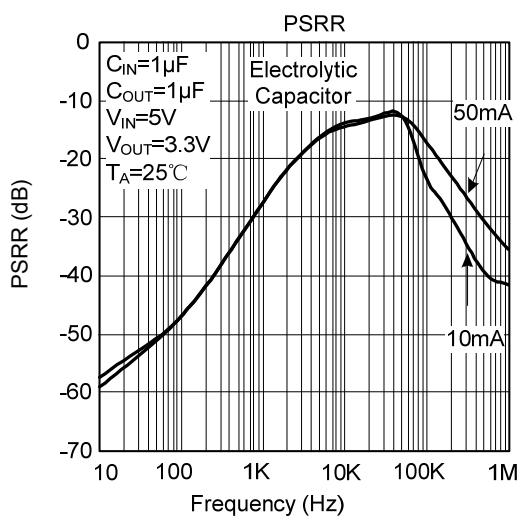
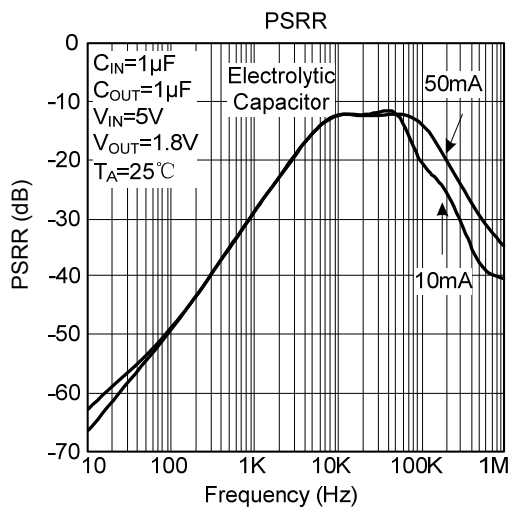
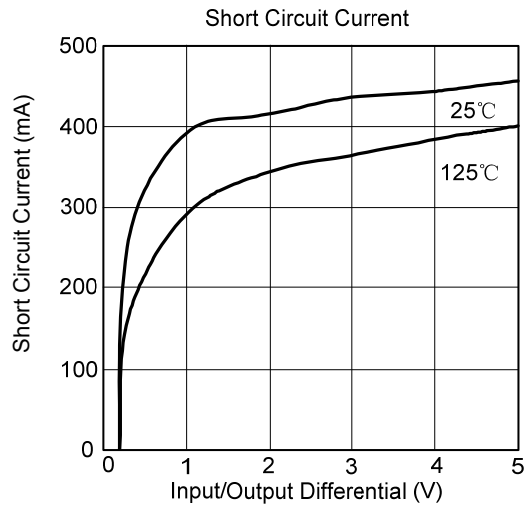
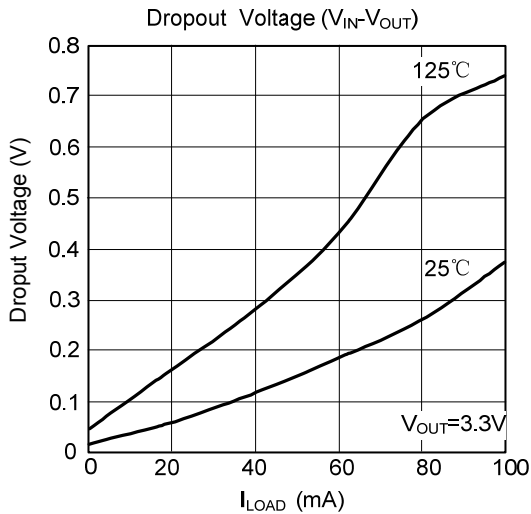
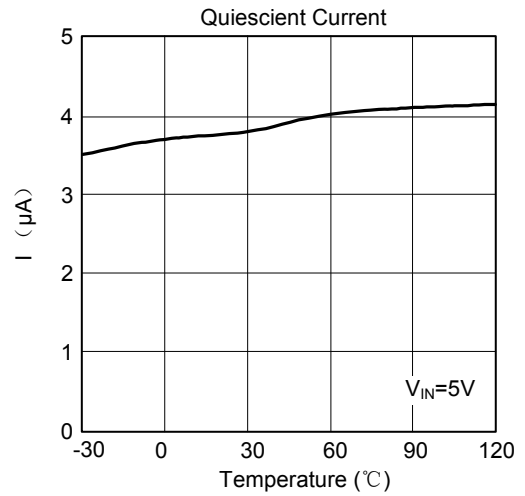
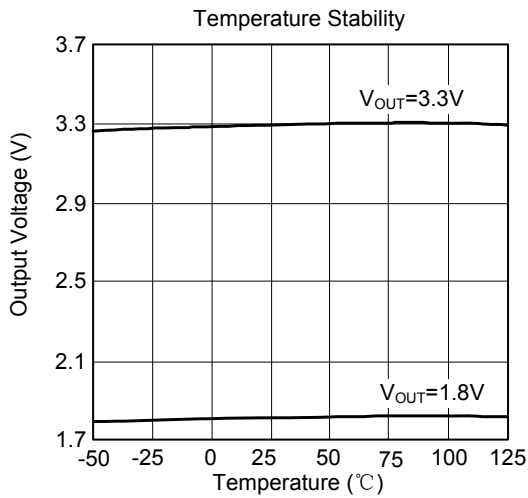

## ■ TYPICAL CHARACTERISTICS(Cont.)

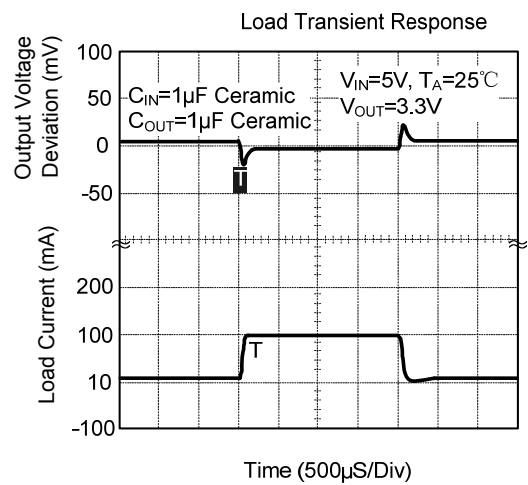
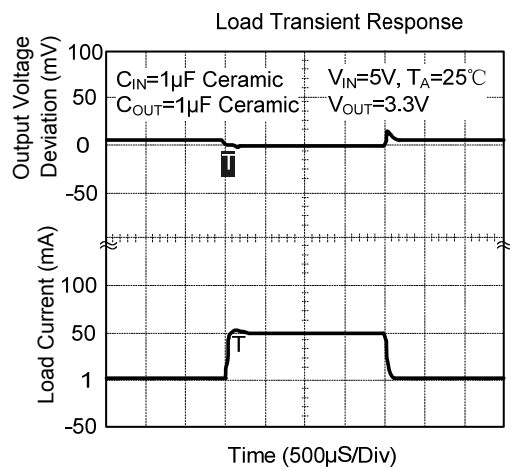
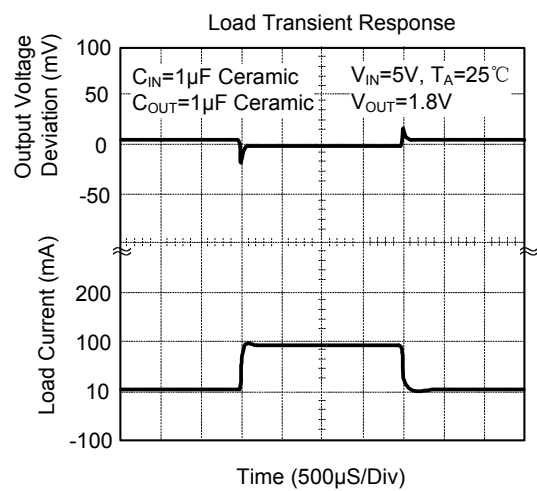
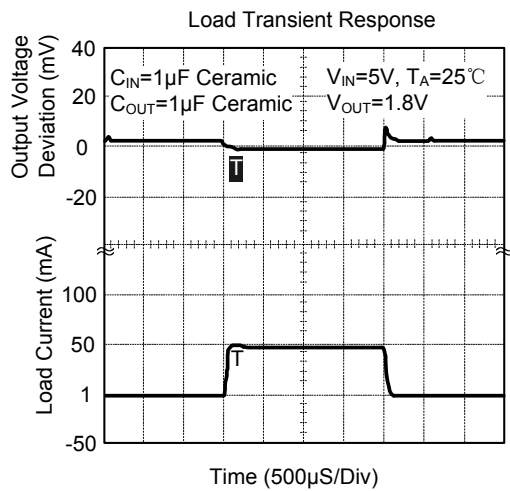
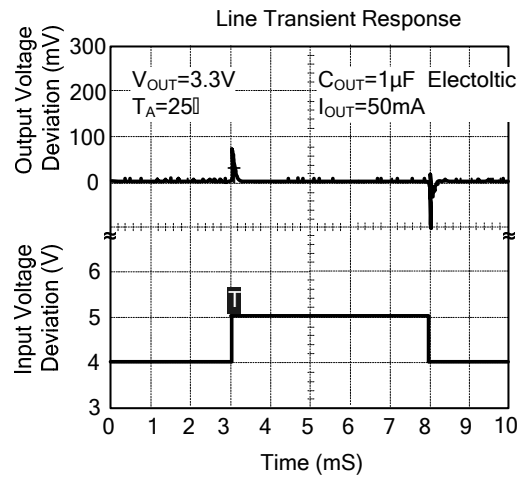
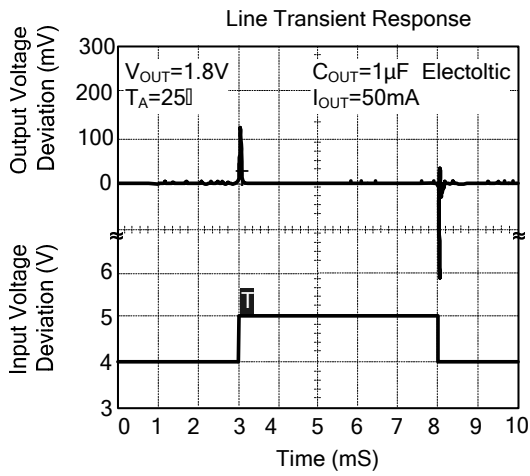

UTC assumes no responsibility for equipment failures that result from using products at values that exceed, even momentarily, rated values (such as maximum ratings, operating condition ranges, or other parameters) listed in products specifications of any and all UTC products described or contained herein. UTC products are not designed for use in life support appliances, devices or systems where malfunction of these products can be reasonably expected to result in personal injury. Reproduction in whole or in part is prohibited without the prior written consent of the copyright owner. The information presented in this document does not form part of any quotation or contract, is believed to be accurate and reliable and may be changed without notice.