

2.7 Ω Low Voltage SPDT Analog Switch in 6-pin SOT363

Features

- Wide Power Supply Range: 1.8V to 5.5V
- High Bandwidth: 300MHz
- High Off-Isolation:
 - 84dB at 1MHz
 - 51dB at 10MHz
- On-Resistance: 2.7 Ω (typ) at 5.0V
- Fast Switching Time
 - $t_{on} = 12.0ns$; $t_{off} = 5.0ns$
- TTL/CMOS Compatible
- Break-Before-Make Switching
- Rail-to-Rail Signal Range
- Operation Temperature Range:
 - 40°C to 85°C
- Lead (Pb) Free SOT363-6 Package

Applications

- Wireless Handsets
- MP3 Players
- Portable Electronic Devices
- Relay Replacement
- PDAs
- Audio & Video Signal Routing
- PCMCIA Cards
- Computer Peripherals
- Modems

Pin Configuration

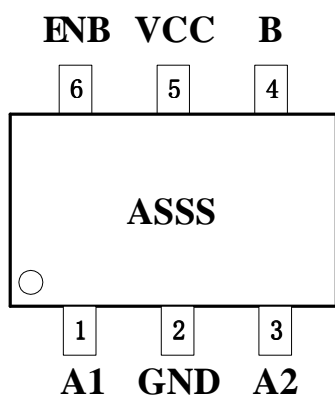

SSS: production id

Description

The BL1551 is a Single Wide-Bandwidth, fast single-pole double-throw (SPDT) CMOS switch featuring an On-Resistance of 2.7 ohm at $V_{CC}=5.0V$ and wide power supply range from 1.8V to 5.5V. It can be used as an analog switch or as a low-delay bus switch.

The 300MHz high bandwidth performance supports the high frequency application.

Break-before-make function for both parts eliminates signal disruption during switching from preventing both switches being enabled simultaneously.

Block Diagram

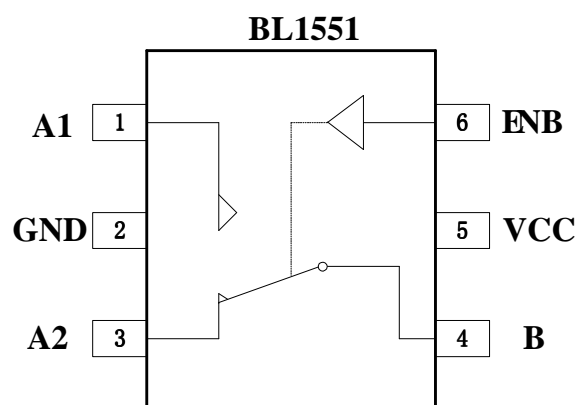

Function Table

ENB	Function
1	A1 Connected to B
0	A2 Connected to B

Pin Description

Pin Name	Type	Description
VCC	PWR	Power Supply
GND	Ground	Ground
B	Input/Output	Data Port
A1	Input/Output	Data Port
A2	Input/Output	Data Port
ENB	Input	Logic Control Signal

ABSOLUTE MAXIMUM RATINGS

Parameter	Symbol	Min	Max	Units
DC Supply Voltage	V_{CC}	-0.3	6	V
DC Switch Voltage	$V_{A1}/ V_{A2}/ V_B$	-0.3	$V_{SUP} + 0.3$	V
DC Input Voltage	V_{ENB}	-0.3	$V_{SUP} + 0.3$	V
Continuous Current	$I_{(A1/A2/B)}$	-200	+200	mA
Peak Current ⁽¹⁾	$I_{PEAK(A1/A2/B)}$	-300	+300	mA
Operating Temperature Range	T_A	-40	85	°C

Notes:

- (1) Pulsed at 1ms, 50% duty circle
- (2) Stress beyond above listed “Absolute Maximum Ratings” may lead permanent damage to the device.
 These are stress ratings only and operations of the device at these or any other conditions beyond those indicated in the operational sections of the specifications are not implied. Exposure to absolute maximum rating conditions for extended periods may affect device reliability.
- (3) Control input(V_{ENB}) must be held HIGH or LOW, and mustn't be floated.

RECOMMENDED OPERATING CONDITIONS

DC Supply Voltage (V_{CC})1.8V to 5.5V
 Switch Input Voltage (V_S)0V to V_{CC}
 Control Input Voltage (V_{ENB})..... 0V to V_{CC}
 Operation Temperature (T_A).....-40°C to +85°C

ORDERING INFORMATION

MODEL	PIN-PACKAGE	SPECIFIED TEMPERATURE RANGE	PACKAGE MARKING	PACKAGE OPTION
BL1551	SOT363 - 6	- 40°C to +85°C	Asss (1)	Tape and Reel, 3000

WHERE (1) :

“sss” IS 3 DIGITS PRODUCTION ID
 SIZE OF ALL OTHER CHARACTERS = 20 mil

COLOUR: LASER MARKING

DC ELECTRICAL CHARACTERISTICS @ +2.7V Supply

Parameter	Symbol	Conditions	Guaranteed Limit			Unit
			Min.	Typ. ⁽¹⁾	Max.	
Analog Switch						
Analog Signal Range	$V_{A1}/V_{A2}/V_B$		0		V_{CC}	V
A1 On-Resistance	$R_{ON(A1)}$	$V_{CC} = 2.7V; I_B = -10mA; V_{A1} = 1.5V$		5.5		Ω
A2 On-Resistance	$R_{ON(A2)}$	$V_{CC} = 2.7V; I_B = -10mA; V_{A2} = 1.5V$		5.5		Ω
A1 On-Resistance Flatness ⁽²⁾	$R_{FLAT(A1)}$	$V_{CC} = 2.7V; I_B = -10mA; V_{A1} = 1.5V$		2.3		Ω
A2 On-Resistance Flatness ⁽²⁾	$R_{FLAT(A2)}$	$V_{CC} = 2.7V; I_B = -10mA; V_{A2} = 1.5V$		2.3		Ω
On-Resistance Match Between Channels ⁽³⁾	ΔR_{ON}	$V_{CC} = 2.7V; I_B = -10mA;$ $V_{A2}/V_{A1} = 1.5$		0.15	1	Ω
A1 or A2 Off Leakage Current	$I_{OFF(A1)}$ OR $I_{OFF(A2)}$	$V_{CC} = 3.6V; V_{A1}$ or $V_{A2} = 3V, 0.3V;$ $V_B = 0.3V, 3V$		0.01	1	μA
B On Leakage Current	$I_{ON(B)}$	$V_{CC} = 3.6V; V_{A1}$ or $V_{A2} = 3.3V, 0.3V;$ $V_B = 0.3V, 3.3V$ or floating		0.01	1	μA
Digital I/O						
Input Voltage High	V_{IH}	Minimum High Level Input Voltage	1			V
Input Voltage Low	V_{IL}	Maximum Low Level Input Voltage			0.5	V
Input Leakage Current	I_{ENB}	$V_{ENB} = 0$ or V_{CC}		0.01	1	μA

Note:

- (1) Typical characteristics are at +3V supply and +25°C
- (2) Flatness is defined as the difference between the maximum and minimum value of on resistance as measured over the specified analog signal ranges.
- (3) $\Delta R_{ON} = R_{ON(MAX)} - R_{ON(MIN)}$, between A1 and A2 .

DYNAMIC CHARACTERISTICS @ +2.7V Supply

Parameter	Symbol	Conditions	Guaranteed Limit			Unit	
			Min.	Typ. ⁽¹⁾	Max.		
AC ELECTRICAL CHARACTERISTICS							
Turn-On Time	t_{ON}	$V_{CC} = 2.7V$; V_{A1} or $V_{A2} = 1.5V$, $R_L = 300\Omega$; $C_L = 35pF$, $V_{IH} = 1.5V, V_{IL} = 0V$		17.0		ns	
Turn-Off Time	t_{OFF}	$V_{CC} = 2.7V$; V_{A1} or $V_{A2} = 1.5V$, $R_L = 300\Omega$; $C_L = 35pF$, $V_{IH} = 1.5V, V_{IL} = 0V$		9.0		ns	
Break-Before-Make Time	t_{BBM}	$V_{CC} = 2.7V$; V_{A1} or $V_{A2} = 1.5V$, $R_L = 300\Omega$; $C_L = 35pF$		15.0		ns	
NC OFF Capacitance	$C_{OFF(A1)}$	$f = 1MHz$		5.5		pF	
NO OFF Capacitance	$C_{OFF(A2)}$	$f = 1MHz$		5.5		pF	
NC ON Capacitance	$C_{ON(A1)}$	$f = 1MHz$		15.5		pF	
NO ON Capacitance	$C_{ON(A2)}$	$f = 1MHz$		15.5		pF	
ADDITIONAL APPLICATION CHARACTERISTICS							
3dB Bandwidth	f_{3dB}	Signal = 0dBm, $R_L = 50\Omega$, $C_L = 5pF$		300		MHz	
Off Isolation ⁽²⁾	V_{Iso}	$R_L = 50\Omega$, $C_L = 5pF$, Signal = 0dBm	$f = 1MHz$		-84		dB
			$f = 10MHz$		-51		dB
Supply							
Power Supply Range	V_{CC}		1.8		5.5	V	

Note:

- (1) Typical characteristics are at +3V supply and 25°C
 (2) Off Channel Isolation = $20\log_{10} [(V_{A1A2})/V_B]$

DC ELECTRICAL CHARACTERISTICS @ +5.0V Supply

Parameter	Symbol	Conditions	Guaranteed Limit			Unit
			Min.	Typ. ⁽¹⁾	Max.	
Analog Switch						
Analog Signal Range	$V_{A1}/V_{A2}/V_B$		0		V_{CC}	V
A1 On-Resistance	$R_{ON(A1)}$	$V_{CC} = 5.0V; I_B = -10mA; V_{A1} = 3.5V$		2.7		Ω
A2 On-Resistance	$R_{ON(A2)}$	$V_{CC} = 5.0V; I_B = -10mA; V_{A2} = 3.5V$		2.7		Ω
A1 On-Resistance Flatness ⁽²⁾	$R_{FLAT(A1)}$	$V_{CC} = 5.0V; I_B = -10mA; V_{A1} = 3.5V$		0.8		Ω
A2 On-Resistance Flatness ⁽²⁾	$R_{FLAT(A2)}$	$V_{CC} = 5.0V; I_B = -10mA; V_{A2} = 3.5V$		0.8		Ω
On-Resistance Match Between Channels ⁽³⁾	ΔR_{ON}	$V_{CC} = 5.0V; I_B = -10mA;$ $V_{A2}/V_{A1} = 3.5$		0.15		Ω
A1 or A2 Off Leakage Current	$I_{OFF(A1)}$ OR $I_{OFF(A2)}$	$V_{CC} = 5.5V; V_{NO}$ or $V_{NC} = 4.5V, 1.0V;$ $V_{COM} = 1.0V, 4.5V$		0.01	1	μA
B On Leakage Current	$I_{ON(B)}$	$V_{CC} = 5.5V; V_{A1}$ or $V_{A2} = 4.5V, 1.0V;$ $V_B = 1.0V, 4.5V$ or floating		0.01	1	μA
Digital I/O						
Input Voltage High	V_{IH}	Minimum High Level Input Voltage	1			V
Input Voltage Low	V_{IL}	Maximum Low Level Input Voltage			0.5	V
Input Leakage Current	I_{ENB}	$V_{ENB} = 0$ or V_{CC}		0.01	1	μA

Note:

- (1) Typical characteristics are at +5.0V supply and +25°C
- (2) Flatness is defined as the difference between the maximum and minimum value of on resistance as measured over the specified analog signal ranges.
- (3) $\Delta R_{ON} = R_{ON(MAX)} - R_{ON(MIN)}$, between A1 and A2 .

DYNAMIC CHARACTERISTICS @ +5.0V Supply

Parameter	Symbol	Conditions	Guaranteed Limit			Unit
			Min.	Typ. ⁽¹⁾	Max.	
AC ELECTRICAL CHARACTERISTICS						
Turn-On Time	t_{ON}	$V_{CC} = 5.0V$; V_{A1} or $V_{A2} = 3.0V$, $R_L = 300\Omega$; $C_L = 35pF$, $V_{IH}=1.5V, V_{IL}=0V$		12.0		ns
Turn-Off Time	t_{OFF}	$V_{CC} = 5.0V$; V_{A1} or $V_{A2} = 3.5V$, $R_L = 300\Omega$; $C_L = 35pF$, $V_{IH}=1.5V, V_{IL}=0V$		5.0		ns
Break-Before-Make Time	t_{BBM}	$V_{CC} = 5.0V$; V_{A1} or $V_{A2} = 3.5V$, $R_L = 300\Omega$; $C_L = 35pF$		8.5		ns
NC OFF Capacitance	$C_{OFF(A1)}$	$f = 1MHz$		5.5		pF
NO OFF Capacitance	$C_{OFF(A2)}$	$f = 1MHz$		5.5		pF
NC ON Capacitance	$C_{ON(A1)}$	$f = 1MHz$		15.5		pF
NO ON Capacitance	$C_{ON(A2)}$	$f = 1MHz$		15.5		pF
ADDITIONAL APPLICATION CHARACTERISTICS						
3dB Bandwidth	f_{3dB}	Signal = 0dBm, $R_L = 50\Omega$, $C_L = 5pF$		300		MHz
Off Isolation ⁽²⁾	V_{Iso}	$R_L = 50\Omega$, $C_L = 5pF$, Signal = 0dBm	$f = 1MHz$		-84	dB
			$f = 10MHz$		-51	dB
Supply						
Power Supply Range	V_{CC}		1.8		5.5	V

Note:

(1) Typical characteristics are at +5.0V supply and 25°C

 (2) Off Channel Isolation = $20\log_{10} [(V_{A1A2})/V_B]$

TEST SETUP CIRCUITS

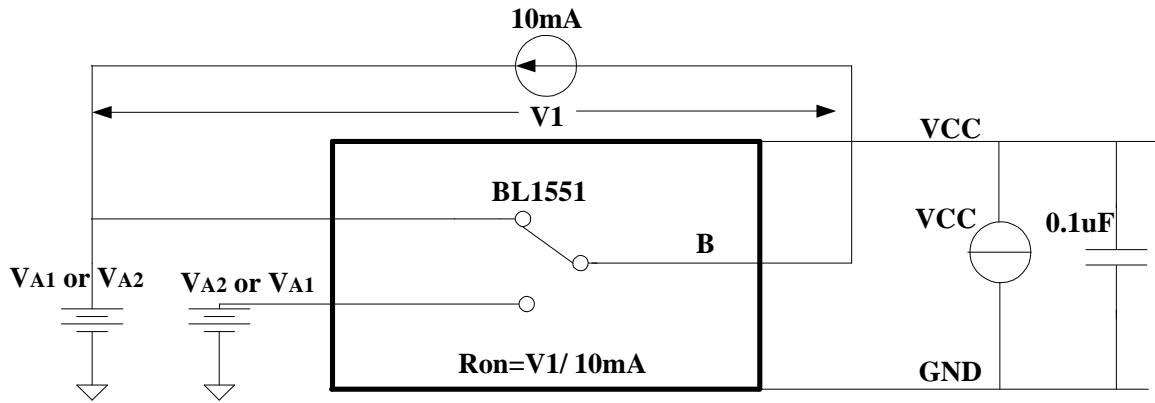

Figure1. Test Circuit for On Resistor

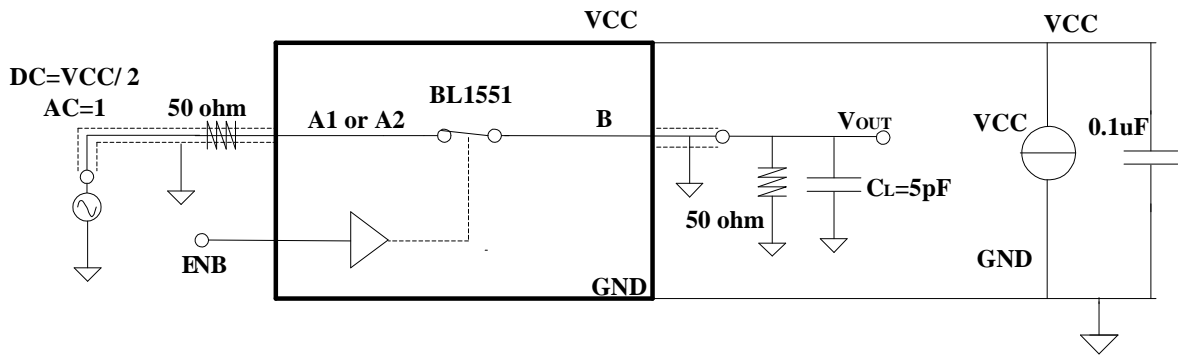

Figure2. Test Circuit for Bandwidth

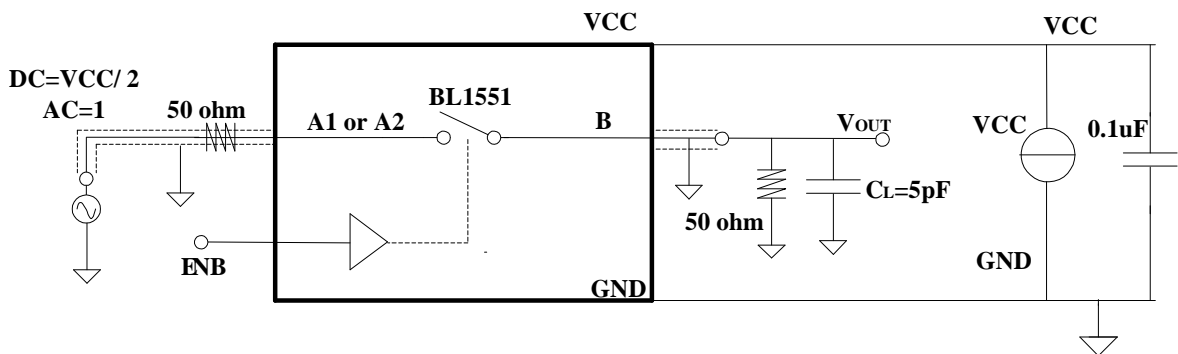
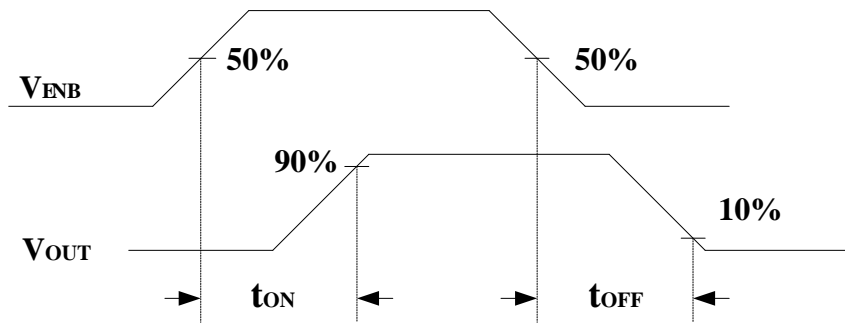
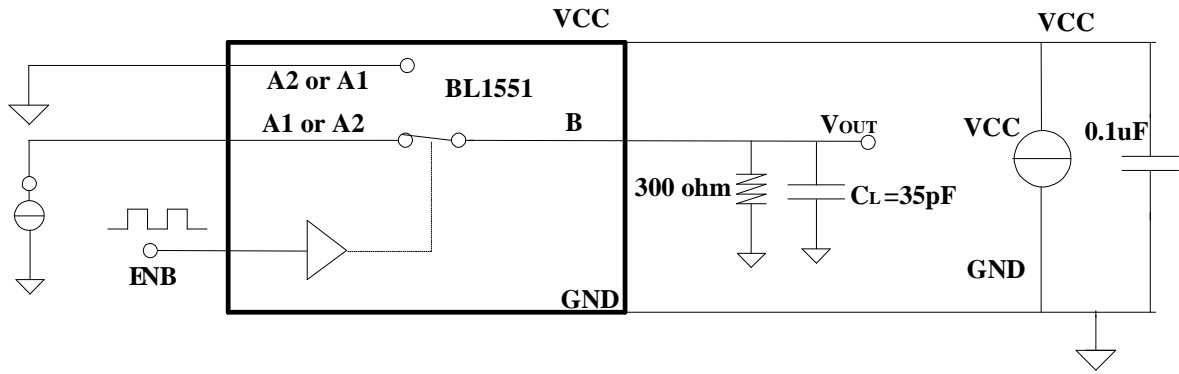
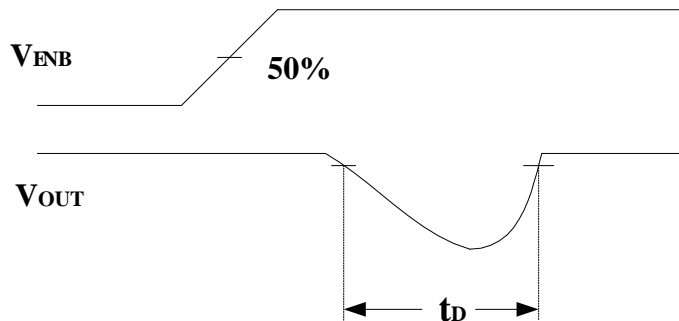
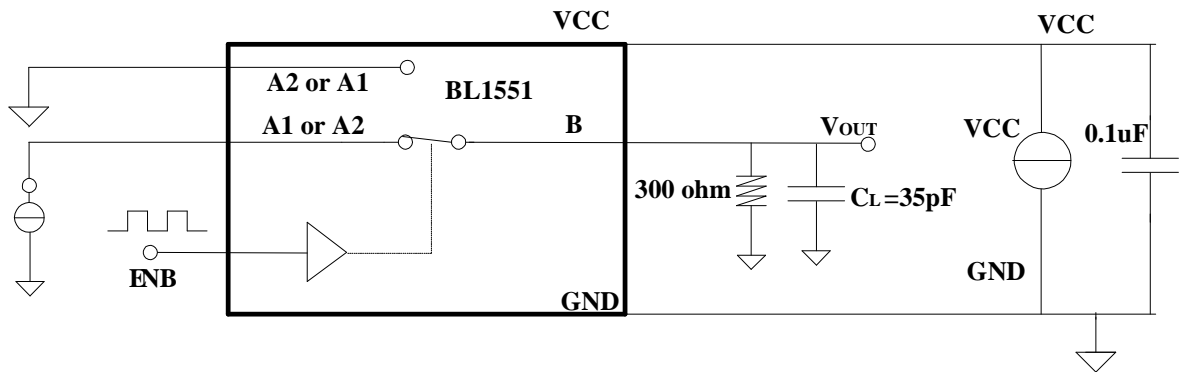

Figure3. Test Circuit for Off Isolation



Test Circuit 4. Test Circuit for Switch Times



Test Circuit 5. Test Circuit for Break-Before-Make Time Delay, t_D

PACKAGE OUTLINE DIMENSIONS (SOT363-6)

SOT363-6

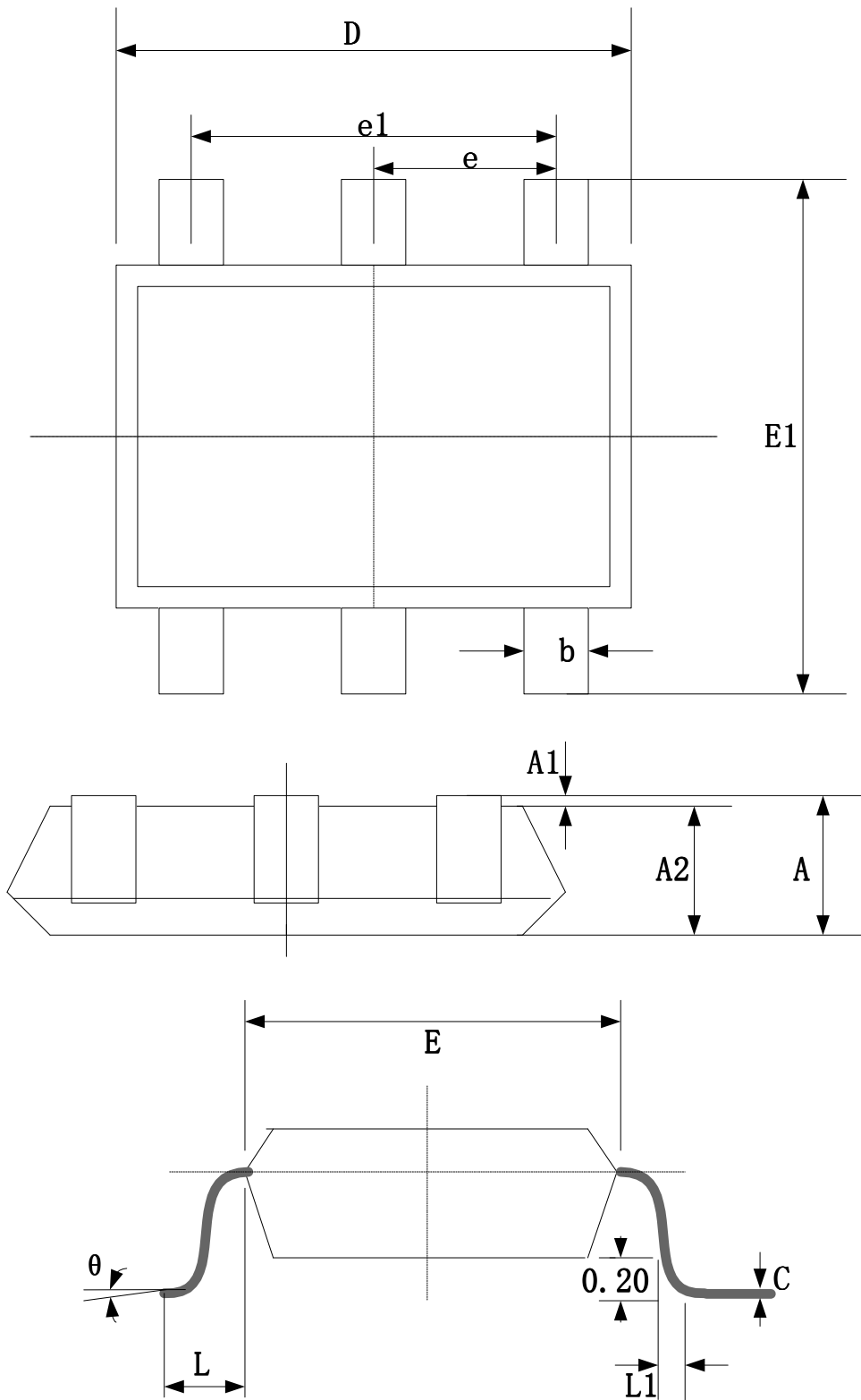

Symbol	Dimensions in Millimeters		Dimensions in Inches	
	Min	Max	Min	Max
A	0.900	1.100	0.035	0.043
A1	0.000	0.100	0.000	0.004
A2	0.900	1.000	0.035	0.039
b	0.150	0.350	0.006	0.014
c	0.080	0.150	0.003	0.006
D	2.000	2.200	0.079	0.087
E	1.150	1.350	0.045	0.053
E1	2.150	2.450	0.085	0.096
e	0.650TYP		0.026TYP	
e1	1.200	1.400	0.047	0.055
L	0.525REF		0.021REF	
L1	0.260	0.460	0.010	0.018
θ	0°	8°	0°	8°