



LV321

LINEAR INTEGRATED CIRCUIT

SINGLE GENERAL PURPOSE, LOW VOLTAGE, RAIL-TO-RAIL OUTPUT OPERATIONAL AMPLIFIER

DESCRIPTION

The UTC **LV321** is a single op amp with low supply current and low voltage (2.7-5.5V) well economic consideration. It brings nice performance and to low voltage, low power systems. With a 1MHz unity-gain frequency, The UTC **LV321** has a guaranteed 1 V/ μ s slew rate and low supply current. It provides heavy rail-to-rail (R-to-R) output swing loads and the input common-mode voltage range including ground. Besides, it is also capable for comfortably driving large capacitive loads.

The UTC **LV321** has bipolar input and CMOS output for improved noise performance and higher output current drive. It's the most cost effective solution for the applications where low voltage operation, space saving and low price are required.

FEATURES

- * 2.7V and 5V Performance Guaranteed
- * No Crossover Distortion
- * 130 μ A Low Supply Current
- * Rail-to-Rail Output Swing @10k Ω Load: V^+ -10mV
 V^- +65mV
- * V_{CM} From -0.2V to V^+ -0.8V

ORDERING INFORMATION

Ordering Number	Package	Packing
LV321G-AF5-R	SOT-25	Tape Reel
LV321G-AL5-R	SOT-353	Tape Reel

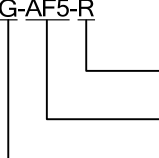
<p>LV321G-AF5-R</p>  <p>(1)Packing Type (2)Package Type (3)Green Package</p>	<p>(1) R: Tape Reel (2) AF5: SOT-25, AL5: SOT-353 (3) G: Halogen Free and Lead Free</p>
---	---

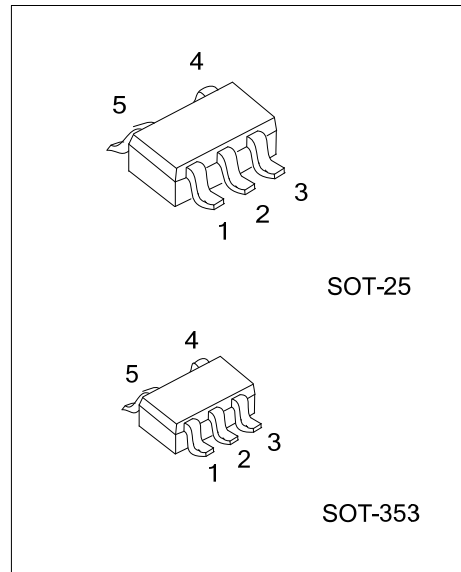

■ MARKING

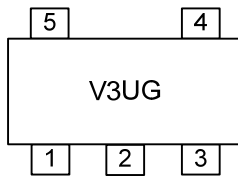

■ PIN CONFIGURATION

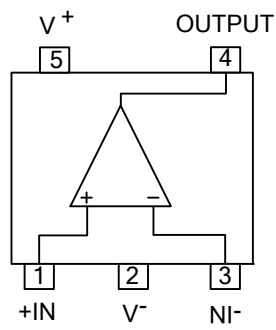

■ ABSOLUTE MAXIMUM RATINGS

PARAMETER		SYMBOL	RATINGS	UNIT
Supply Voltage		V_{SS}	2.7 ~ 5.5	V
Supply Voltage ($V^+ - V^-$)		V_{SS}	5.5	V
Differential Input Voltage		$V_{I(DIFF)}$	\pm Supply Voltage	
Output Short Circuit	V^+	$I_{O(SC)}$	(Note 2)	
	V^-		(Note 3)	
Infrared (15 sec)			215	$^{\circ}$ C
Junction Temperature		T_J	+150	$^{\circ}$ C
Operation Temperature		T_{OPR}	-40~+85	$^{\circ}$ C
Storage Temperature		T_{STG}	-65~+150	$^{\circ}$ C

Notes: 1. Absolute maximum ratings are those values beyond which the device could be permanently damaged.

Absolute maximum ratings are stress ratings only and functional device operation is not implied.

2. Shorting output to V^+ will adversely affect reliability.

3. Shorting output to V^- will adversely affect reliability

■ THERMAL DATA

PARAMETER		SYMBOL	RATING	UNIT
Junction to Ambient	SOT-25	θ_{JA}	265	$^{\circ}$ C/W
	SOT-353		478	$^{\circ}$ C/W

■ 2.7V ELECTRICAL CHARACTERISTICS

All limits guaranteed for $T_J = 25^{\circ}$ C, $V^+ = 2.7$ V, $V^- = 0$ V, $V_{CM} = 1.0$ V, $V_{OUT} = V^+/2$ and $R_L > 1$ M Ω , unless otherwise specified.

PARAMETER	SYMBOL	CONDITIONS	MIN	TYP	MAX	UNIT
DC CHARACTERISTICS						
Input Offset Voltage	V_{OS}			1.7	7	mV
Input Common Mode Voltage Range	V_{CM}	For $CMRR \geq 50$ dB	0	-0.2		V
				1.9	1.7	V
Output Swing	V_{OUT}	$R_L = 10$ k Ω to 1.35V	$V^+ - 100$	$V^+ - 10$		mV
				60	180	mV
Input Offset Voltage Average Drift	TCV_{OS}			5		μ V/ $^{\circ}$ C
Input Bias Current	$I_{I(BIAS)}$			11	250	nA
Input Offset Current	$I_{I(OFF)}$			5	50	nA
Common Mode Rejection Ratio	CMRR	$0V \leq V_{CM} \leq 1.7V$	50	63		dB
Power Supply Rejection Ratio	PSRR	$2.7V \leq V^+ \leq 5V$, $V_{OUT} = 1V$	50	60		dB
Supply Current	I_{SS}			80	170	μ A
AC CHARACTERISTICS						
Gain Bandwidth Product	GBWP	$C_L = 200$ pF		1		MHz
Phase Margin	Φ_m			60		Deg
Gain Margin	G_m			10		dB
Input Referred Voltage Noise	eN	F=1kHz		46		$\frac{nV}{\sqrt{Hz}}$
Input Referred Current Noise	i_n	F=1kHz		0.17		$\frac{pA}{\sqrt{Hz}}$

■ 5V ELECTRICAL CHARACTERISTICS

All limits guaranteed for $T_J = 25^\circ\text{C}$, $V^+ = 5\text{V}$, $V^- = 0\text{V}$, $V_{\text{CM}} = 2.0\text{V}$, $V_{\text{OUT}} = V^+/2$ and $R_L > 1\text{M}\Omega$, unless otherwise specified.

PARAMETER	SYMBOL	CONDITIONS	MIN	TYP	MAX	UNIT	
DC CHARACTERISTICS							
Input Offset Voltage	V_{OS}			1.7	7	mV	
Input Common-Mode Voltage Range	V_{CM}	For $\text{CMRR} \geq 50\text{dB}$	0	-0.2		V	
				4.2	4	V	
Output Swing	V_{OUT}	$R_L = 2\text{k}\Omega$ to 2.5V	V_{OH}	$V^+ - 300$	$V^+ - 40$	mV	
			V_{OL}		120	300	mV
		$R_L = 10\text{k}\Omega$ to 2.5V	V_{OH}	$V^+ - 100$	$V^+ - 10$		mV
			V_{OL}		65	180	mV
Input Offset Voltage Average Drift	TCVos			5		$\mu\text{V}/^\circ\text{C}$	
Input Bias Current	$I_{\text{I(BIAS)}}$			15	250	nA	
Input Offset Current	$I_{\text{I(OFF)}}$			5	50	nA	
Common Mode Rejection Ratio	CMRR	$0\text{V} \leq V_{\text{CM}} \leq 4\text{V}$	50	65		dB	
Power Supply Rejection Ratio	PSRR	$2.7\text{V} \leq V^+ \leq 5\text{V}$ $V_{\text{OUT}} = 1\text{V}$, $V_{\text{CM}} = 1\text{V}$	50	60		dB	
Large Signal Voltage Gain(Note 1)	G_V	$R_L = 2\text{k}\Omega$	15	100		V/mV	
Output Short Circuit Current	I_{OUT}	Sourcing, $V_{\text{OUT}} = 0\text{V}$	5	60		mA	
		Sinking, $V_{\text{OUT}} = 5\text{V}$	10	160		mA	
Supply Current	I_{SS}			130	250	μA	
AC CHARACTERISTICS							
Slew Rate	SR	(Note 2)		1		V/ μs	
Gain Bandwidth Product	GBWP	$C_L = 200\text{pF}$		1		MHz	
Phase Margin	Φ_m			60		Deg	
Gain Margin	G_m			10		dB	
Input Referred Voltage Noise	eN	$f = 1\text{kHz}$		39		$\frac{\text{nV}}{\sqrt{\text{Hz}}}$	
Input Referred Current Noise	i_n	$f = 1\text{kHz}$		0.21		$\frac{\text{pA}}{\sqrt{\text{Hz}}}$	

Notes: 1. R_L is connected to V^- . The output voltage is $0.5\text{V} \leq V_{\text{OUT}} \leq 4.5\text{V}$.

2. Connected as voltage follower with 3V step input. Number specified is these lower of the positive and negative slew rates

3. All numbers are typical, and apply for packages soldered directly note a PC board is still air.

TYPICAL CHARACTERISTICS

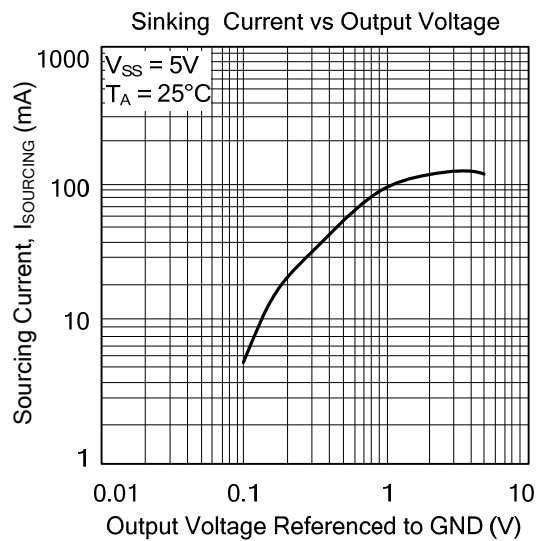
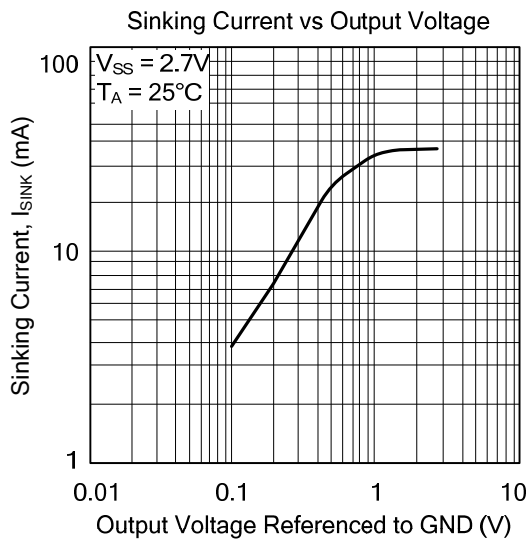
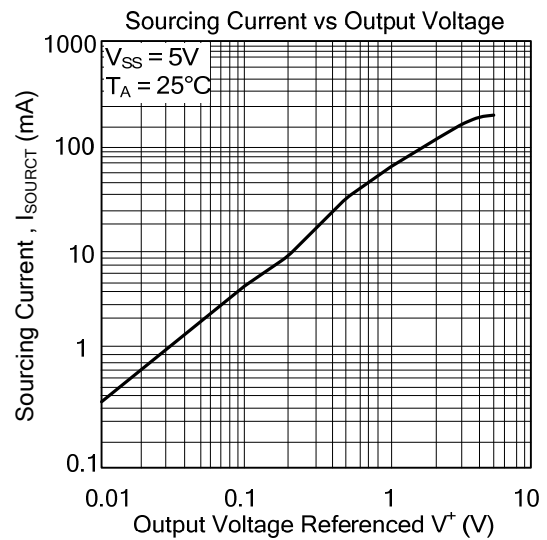
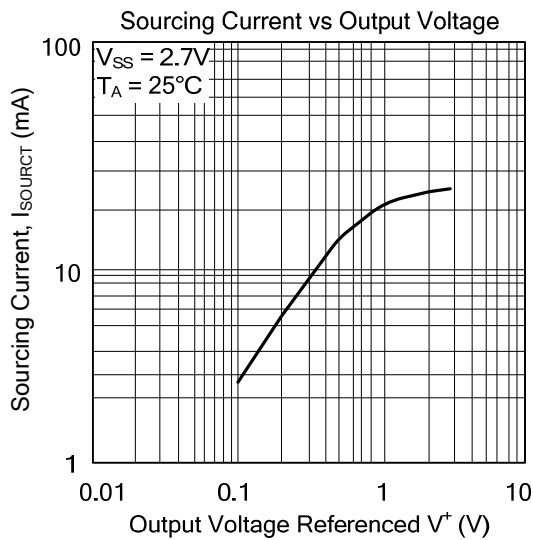
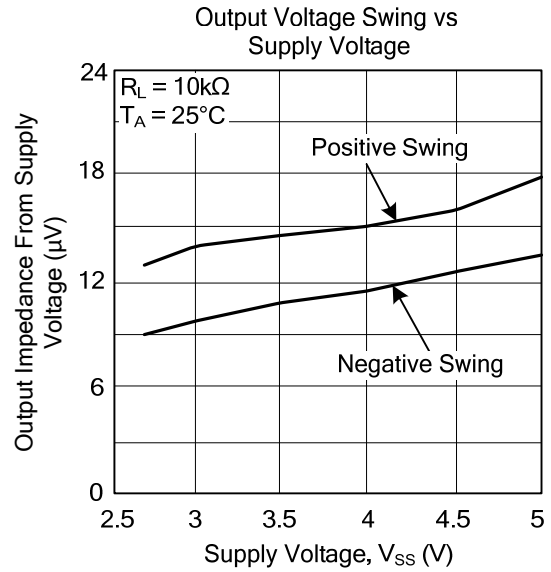
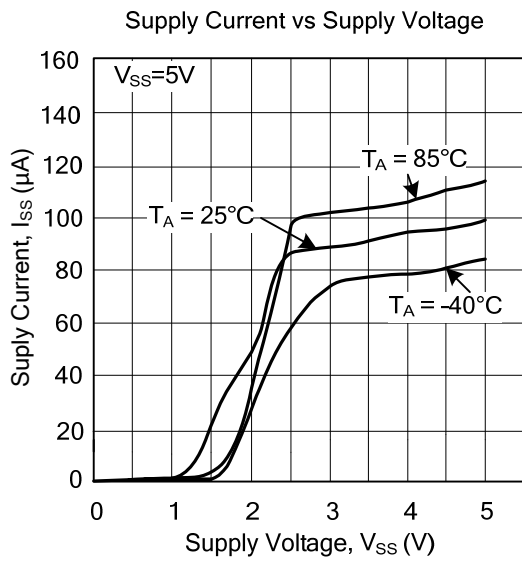

■ TYPICAL CHARACTERISTICS (Cont.)

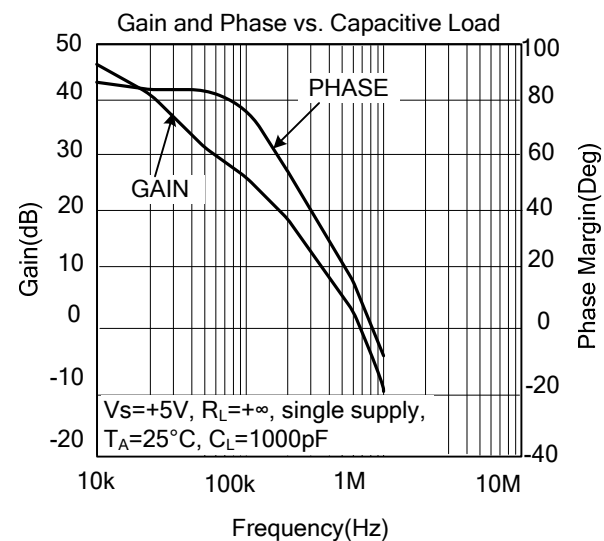
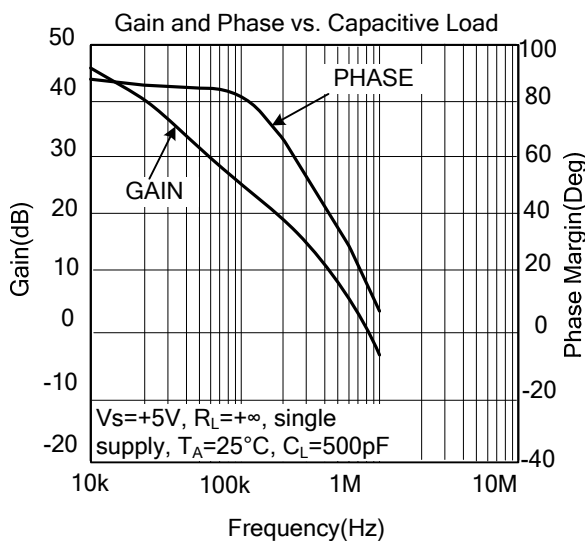
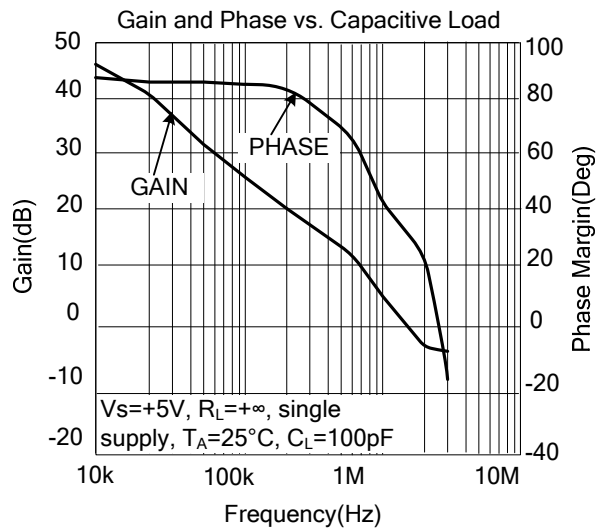
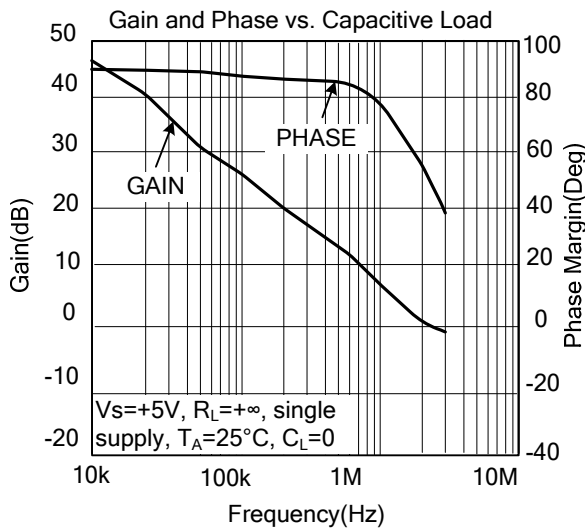
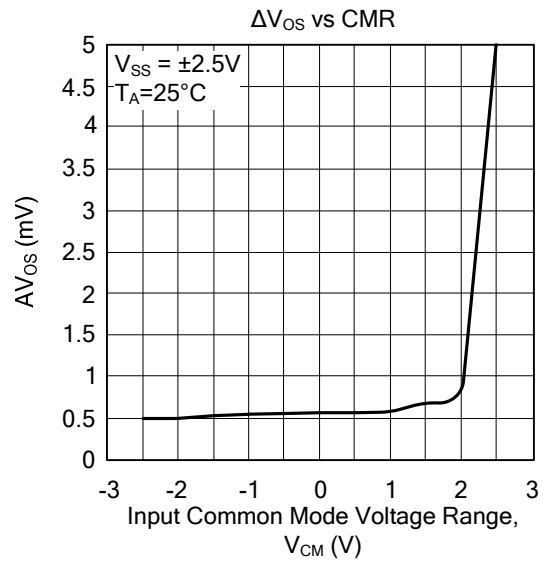
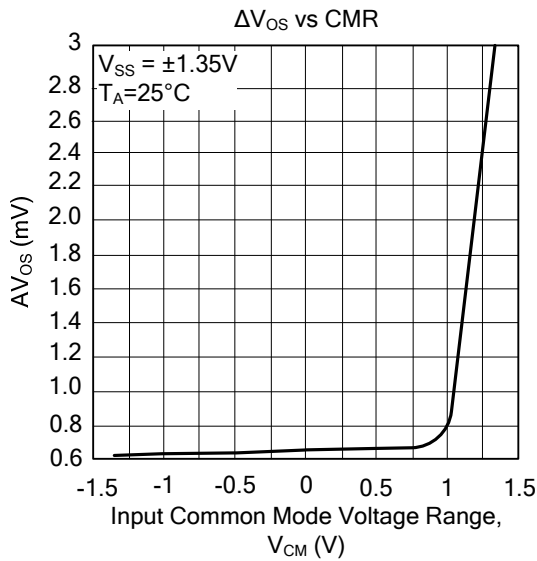

■ TYPICAL CHARACTERISTICS (Cont.)

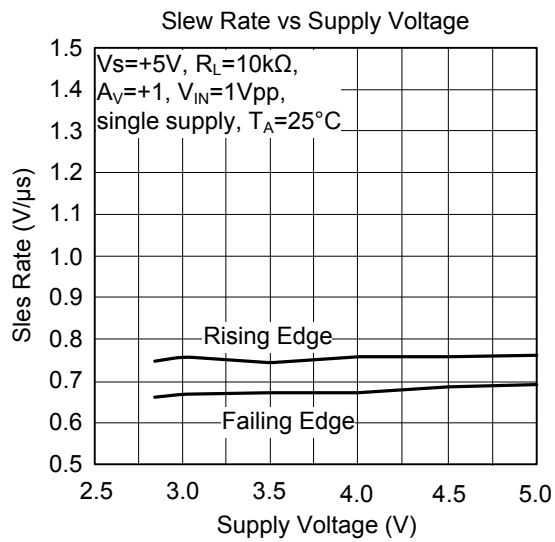
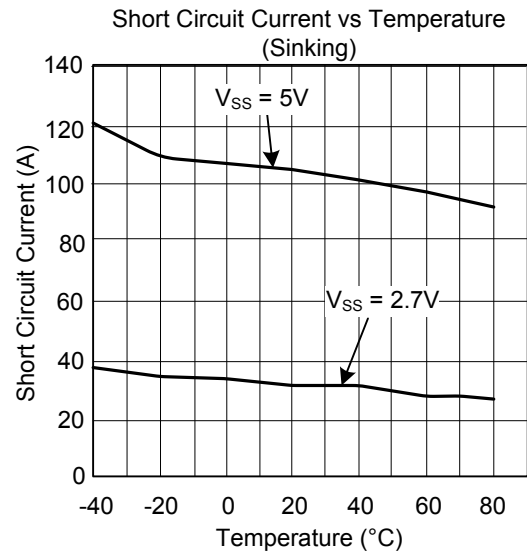
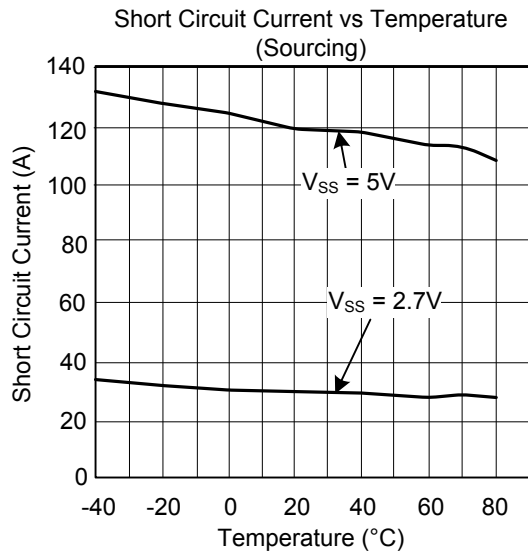

■ TYPICAL CHARACTERISTICS (Cont.)

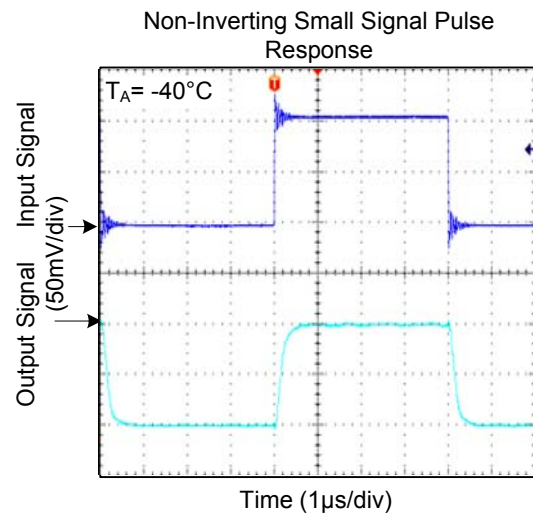
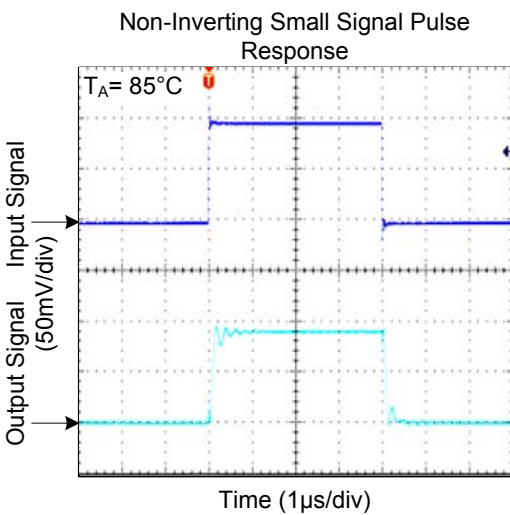
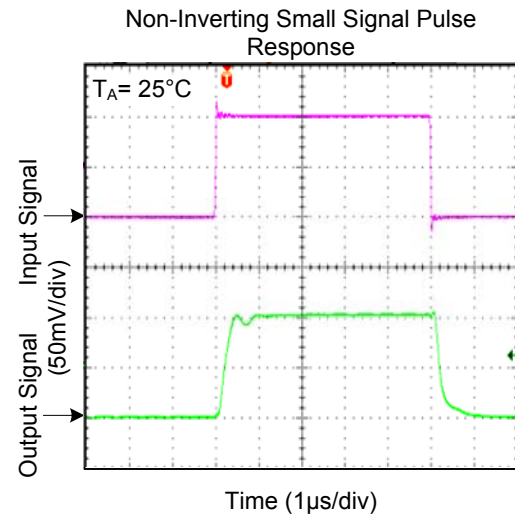
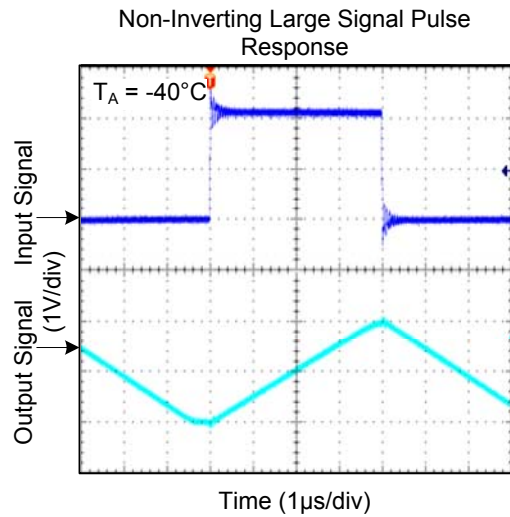
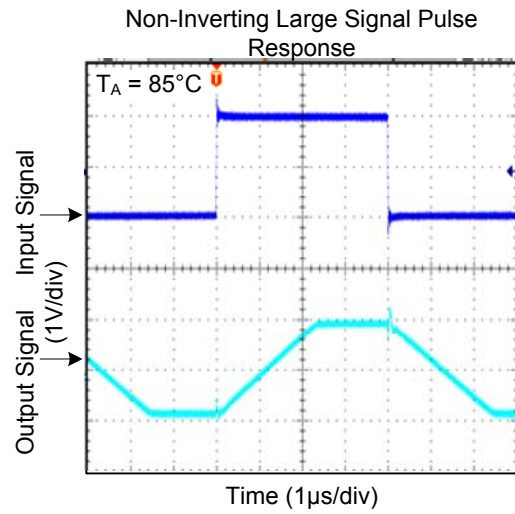
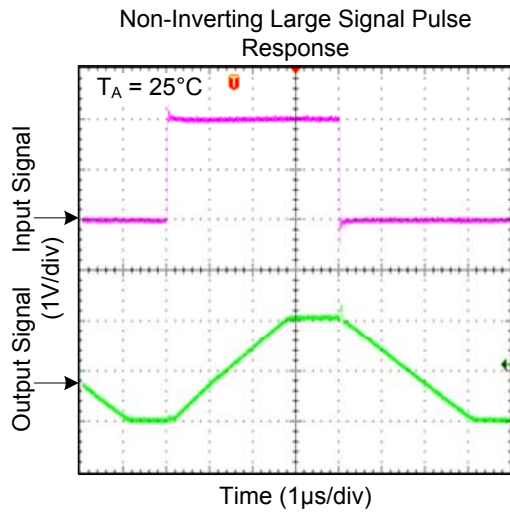

■ TYPICAL CHARACTERISTICS (Cont.)

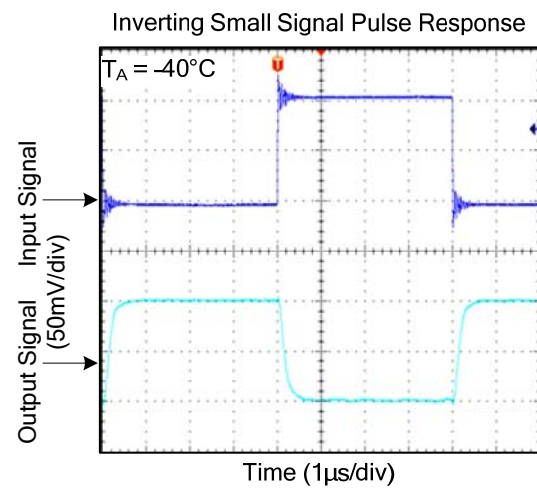
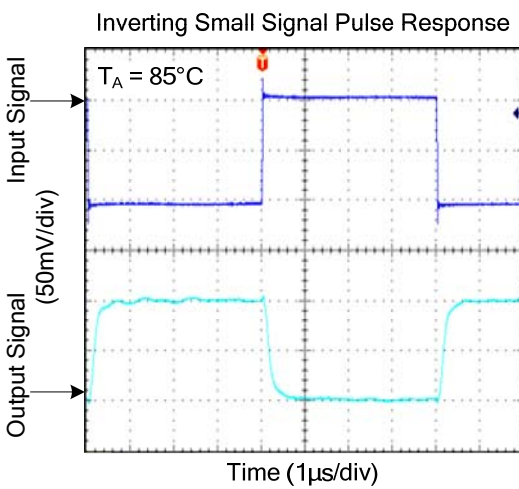
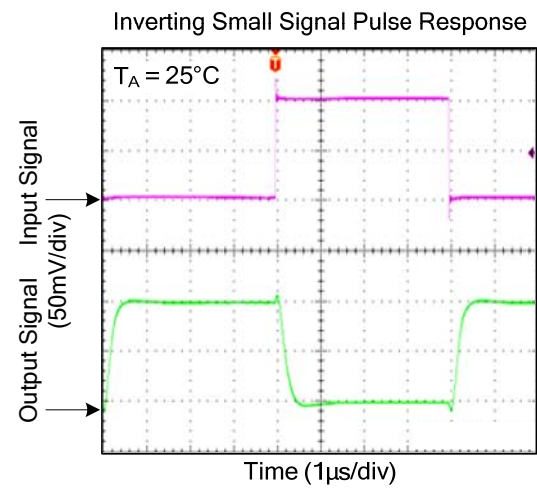
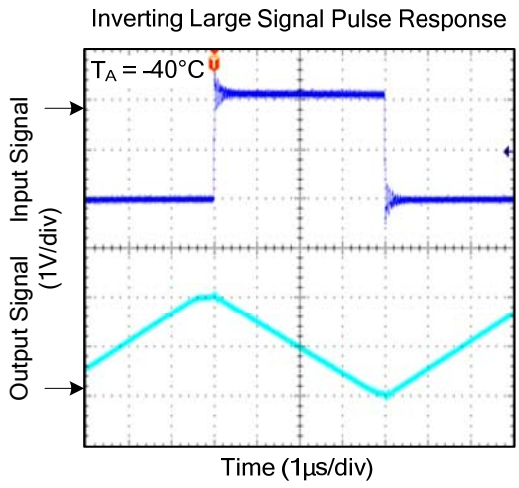
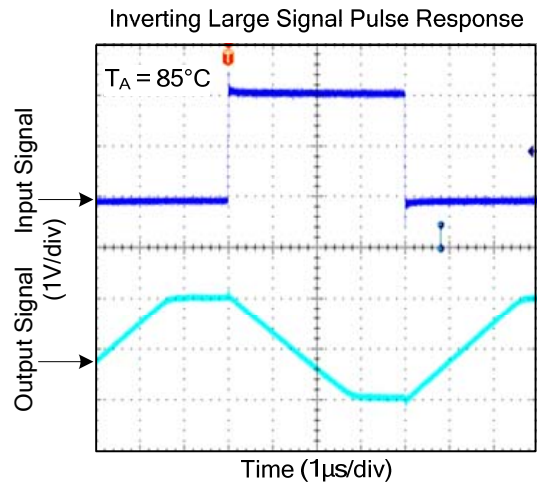
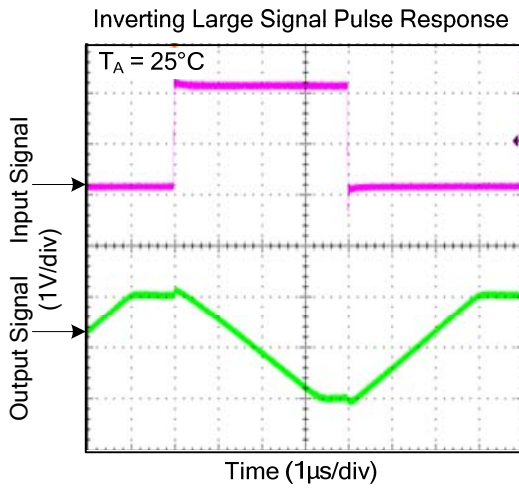

UTC assumes no responsibility for equipment failures that result from using products at values that exceed, even momentarily, rated values (such as maximum ratings, operating condition ranges, or other parameters) listed in products specifications of any and all UTC products described or contained herein. UTC products are not designed for use in life support appliances, devices or systems where malfunction of these products can be reasonably expected to result in personal injury. Reproduction in whole or in part is prohibited without the prior written consent of the copyright owner. The information presented in this document does not form part of any quotation or contract, is believed to be accurate and reliable and may be changed without notice.