

800mA Adjustable Voltage High Speed LDO Regulators BL9118 Series

General Description

The BL9118 series are highly accurate, low noise, LDO Voltage Regulators that are capable of providing an output current that is in excess of 800mA with a maximum dropout voltage of 1.0V at 800mA (BL9118-1.8V). This series contains three fixed output voltages of 1.2V, 1.8V and 2.5V that have no minimum load requirement to maintain regulation. On chip trimming adjusts the reference/output voltage to within $\pm 2\%$ accuracy. Internal protection features consist of output current limiting, safe operating area compensation, and thermal shutdown. The BL9118 series can operate with up to 15V input. Devices are available in SOT223.

Features

- Output Current in Excess of 800mA
- Dropout Voltage: 115mV @ $I_{OUT} = 100mA$ (BL9118-1.8V)
- Operating Voltage Range: 2.5V ~ 15V
- Highly Accuracy: $\pm 2\%$
- Adjustable Output Voltage Option
- Standby Current: 52uA (TYP.)
- High Ripple Rejection: 70dB @ 1KHz (BL9118-1.8V)
- Line Regulation: 2mV (TYP.)
- Temperature Stability $\leq 0.5\%$
- Thermal Shutdown Protection: 160°C
- Packages: SOT223

Selection Guide

BL9118-VVV X X XX

Package:
F: SOT-223-3

Features:
P: Standard (default, lead free)
C: Customized

Output Voltage Accuracy

A: $\pm 1\%$

B: $\pm 2\%$

Output Voltage

120: 1.2V 180: 1.8V

250: 2.5V

Typical Application

- Consumer and Industrial Equipment Point of Regulation
- Switching Power Supply Post Regulation
- Hard Drive Controllers
- Battery Chargers

Typical Application Circuit

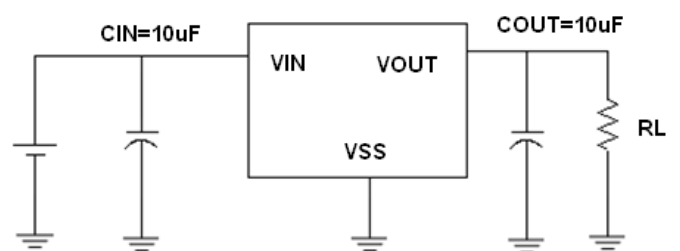

Pin Configuration

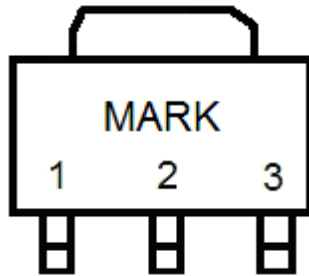

SOT223

Pin Assignment

BL9118

Pin Number	Pin Name	Functions
SOT223		
1	GND	Ground
2	V _{OUT}	Output
3	V _{IN}	Power Input

BL9118E

Pin Number	Pin Name	Functions
SOT223		
1	GND	Ground
3	V _{OUT}	Output
2	V _{IN}	Power Input

Absolute Maximum Ratings

Parameter	Symbol	Ratings	Units
Input Voltage	V _{IN}	18	V
Output Current	I _{OUT}	1.1	A
Output Voltage	V _{OUT}	V _{SS} -0.3~V _{IN} +0.3	V
Power Dissipation	SOT223 P _D	750	mW
Operating Temperature Range	T _{OPR}	-40~+125	°C
Storage Temperature Range	T _{STG}	-40~+150	°C
Lead Temperature		260°C, 4sec	

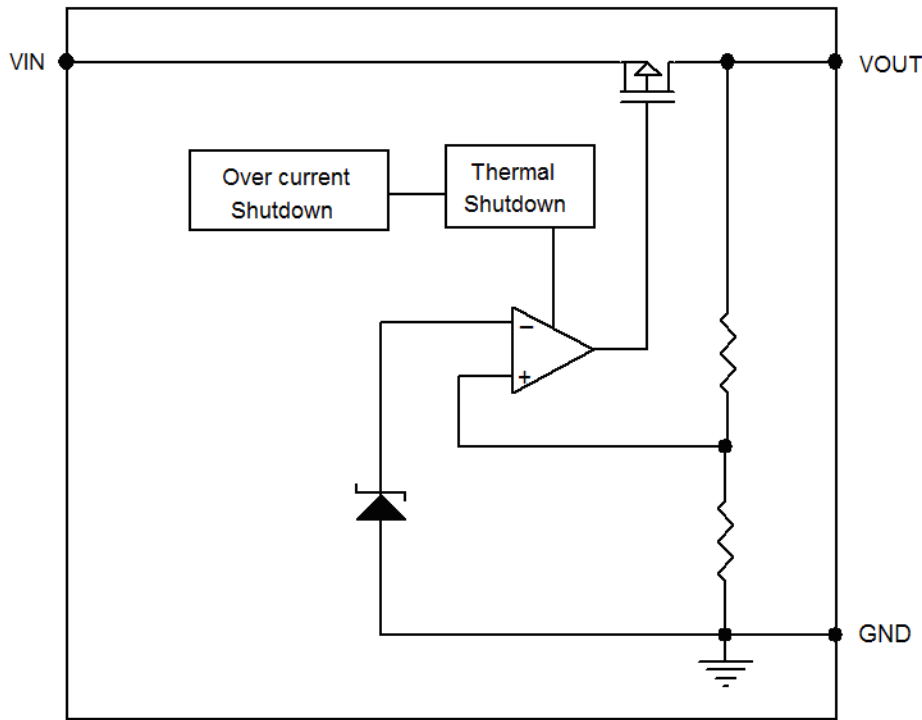
Block Diagram

Electrical Characteristics
BL9118-1.2V

($V_{IN} = V_{OUT} + 1.3V$, $C_{IN} = C_L = 10\mu F$, $T_a = 25^\circ C$, unless otherwise noted)

Parameter	Symbol	Conditions	Min.	Typ.	Max.	Units
Output Voltage	$V_{OUT(E)}$ (Note 2)	$I_{OUT} = 10mA$, $V_{IN} = V_{OUT} + 1.3V$	X 0.98	$V_{OUT(T)}$ (Note 1)	X 1.02	V
Maximum Output Current	I_{OUTMAX}	$V_{IN} = V_{OUT} + 1.3V$		800		mA
Load Regulation	ΔV_{OUT}	$V_{IN} = V_{OUT} + 1.3V$, $1mA \leq I_{OUT} \leq 800mA$		3	10	mV
Dropout Voltage (Note 3)	V_{DIF1}	$I_{OUT} = 100mA$		195		mV
	V_{DIF2}	$I_{OUT} = 400mA$		665		mV
	V_{DIF3}	$I_{OUT} = 800mA$		1250		mV
Quiescent Current	I_{SS}	$V_{IN} = V_{OUT} + 1.3V$		53		μA
Line Regulation	ΔV_{OUT}	$I_{OUT} = 0mA$ $V_{OUT} + 1.3V \leq V_{IN} \leq 18V$		2	10	mV

Ripple Rejection Rate	PSRR	$V_{IN}=4.2V$ $+1Vp-pAC$	$I_{OUT}=100mA, 1kHz$		70	dB
			$I_{OUT}=200mA, 1kHz$		68	
			$I_{OUT}=500mA, 1kHz$		61	

BL9118-1.8V
 $(V_{IN}=V_{OUT}+1.2V, C_{IN}=C_L=10\mu F, T_a=25^{\circ}C, \text{ unless otherwise noted})$

Parameter	Symbol	Conditions	Min.	Typ.	Max.	Units
Output Voltage	$V_{OUT(E)}$ (Note 2)	$I_{OUT}=10mA,$ $V_{IN}=V_{OUT}+1.2V$	X 0.98	$V_{OUT(T)}$ (Note 1)	X 1.02	V
Maximum Output Current	I_{OUTMAX}	$V_{IN}=V_{OUT}+1.2V$		800		mA
Load Regulation	ΔV_{OUT}	$V_{IN}=V_{OUT}+1.2V,$ $1mA \leq I_{OUT} \leq 800mA$		5	10	mV
Dropout Voltage (Note 3)	V_{DIF1}	$I_{OUT}=100mA$		115		mV
	V_{DIF2}	$I_{OUT}=400mA$		450		mV
	V_{DIF3}	$I_{OUT}=800mA$		940		mV
Quiescent Current	I_{SS}	$V_{IN}=V_{OUT}+1.2V$		52		μA
Line Regulation	ΔV_{OUT}	$I_{OUT}=0mA$ $V_{OUT}+1.2V \leq V_{IN} \leq 18V$		2	10	mV
Ripple Rejection Rate	PSRR	$V_{IN}=4.8V$ $+1Vp-pAC$	$I_{OUT}=100mA, 1kHz$		70	dB
			$I_{OUT}=200mA, 1kHz$		68	
			$I_{OUT}=500mA, 1kHz$		61	

BL9118-2.5V
 $(V_{IN}=V_{OUT}+1.2V, C_{IN}=C_L=10\mu F, T_a=25^{\circ}C, \text{ unless otherwise noted})$

Parameter	Symbol	Conditions	Min.	Typ.	Max.	Units
Output Voltage	$V_{OUT(E)}$ (Note 2)	$I_{OUT}=10mA,$ $V_{IN}=V_{OUT}+1.2V$	X 0.98	$V_{OUT(T)}$ (Note 1)	X 1.02	V
Maximum Output Current	I_{OUTMAX}	$V_{IN}=V_{OUT}+1.2V$		1000		mA
Load Regulation	ΔV_{OUT}	$V_{IN}=V_{OUT}+1.2V,$ $1mA \leq I_{OUT} \leq 1000mA$		5	10	mV
Dropout Voltage (Note 3)	V_{DIF1}	$I_{OUT}=100mA$		90		mV
	V_{DIF2}	$I_{OUT}=500mA$		450		mV
	V_{DIF3}	$I_{OUT}=1000mA$		990		mV
Quiescent Current	I_{SS}	$V_{IN}=V_{OUT}+1.2V$		53		μA
Line Regulation	ΔV_{OUT}	$I_{OUT}=0mA$ $V_{OUT}+1.2V \leq V_{IN} \leq 18V$		2	10	mV

Ripple Rejection Rate	PSRR	$V_{IN}=5.5V$ $+1V_{p-pAC}$	$I_{OUT}=100mA, 1kHz$		70		dB
			$I_{OUT}=200mA, 1kHz$		68		
			$I_{OUT}=500mA, 1kHz$		61		

Note :

- $V_{OUT}(T)$: Specified Output Voltage
- $V_{OUT}(E)$: Effective Output Voltage (ie. The output voltage when " $V_{OUT}(T)+1.2V$ " is provided at the Vin pin while maintaining a certain Iout value.)
- $V_{DIF}: V_{IN1}-V_{OUT}(E)'$
 V_{IN1} : The input voltage when $V_{OUT}(E)'$ appears as input voltage is gradually decreased.
 $V_{OUT}(E)'$ = A voltage equal to 98% of the output voltage whenever an amply stabilized Iout and $\{V_{OUT}(T)+1.2V\}$ is input.

Type Characteristics

(1) Output Voltage VS. Output Current

BL9118-1.2V ($V_{IN}=V_{OUT}+1.3V$)

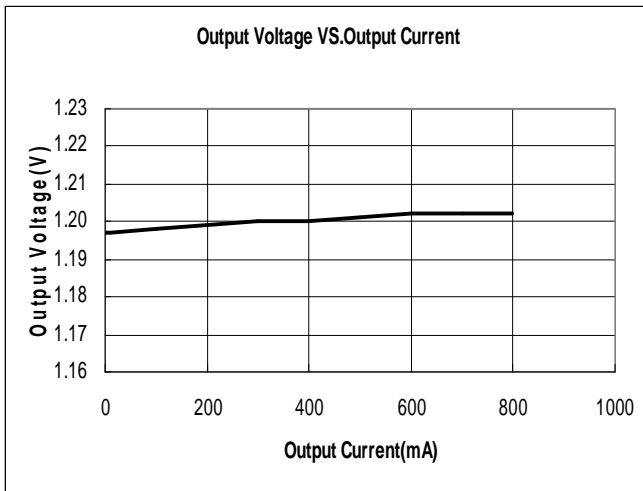

BL9118-1.8V ($V_{IN}=V_{OUT}+1.2V$)

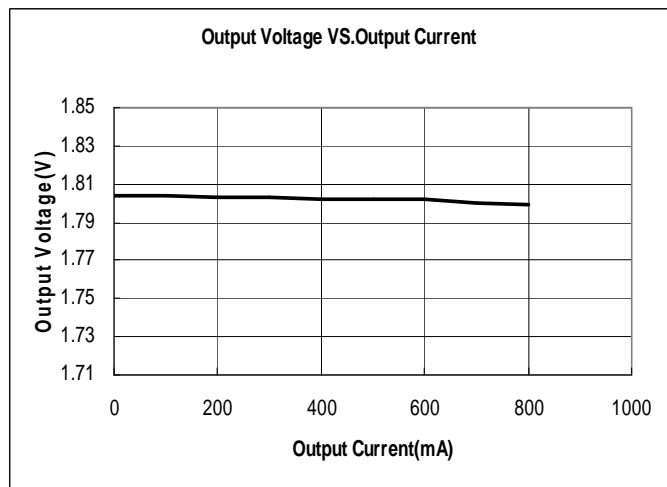

BL9118-2.5V ($V_{IN}=V_{OUT}+1.2V$)

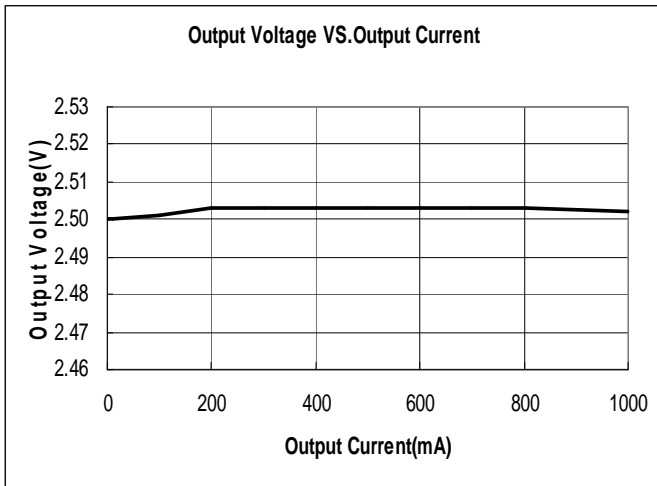

(2) Output Voltage VS. Temperature

BL9118-1.2V ($V_{IN}=V_{OUT}+1.3V$, $I_{OUT}=10mA$)

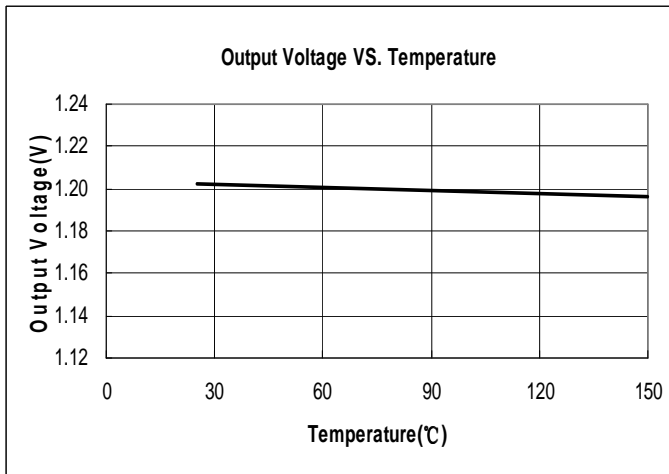

BL9118-1.8V ($V_{IN}=V_{OUT}+1.2V$, $I_{OUT}=10mA$)

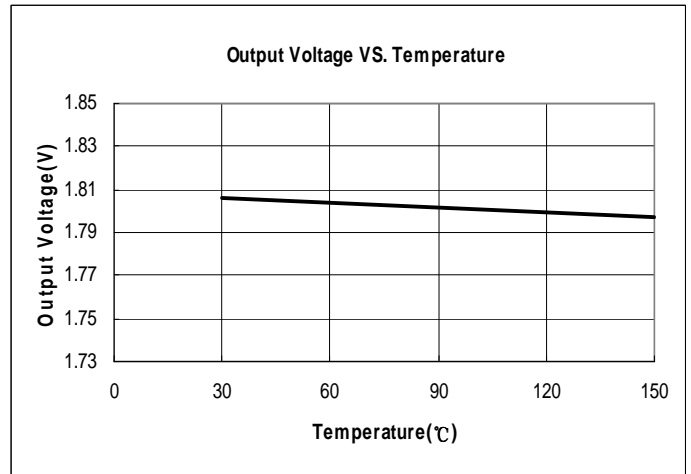

BL9118-2.5V ($V_{IN}=V_{OUT}+1.2V$, $I_{OUT}=10mA$)

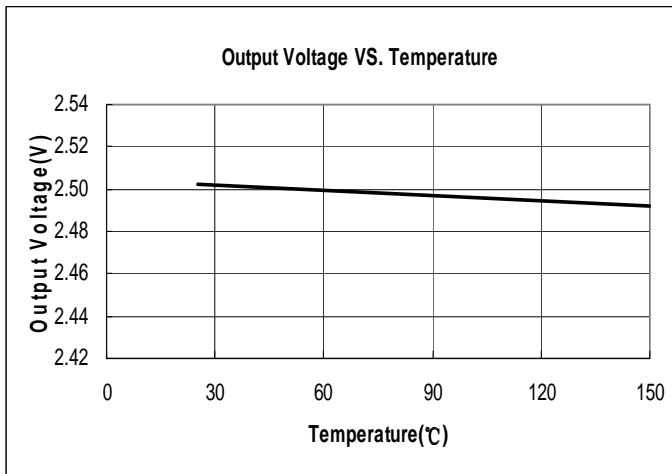

(3) Dropout Voltage VS. Output Current ($T_a = 25^\circ\text{C}$)

BL9118-1.2V

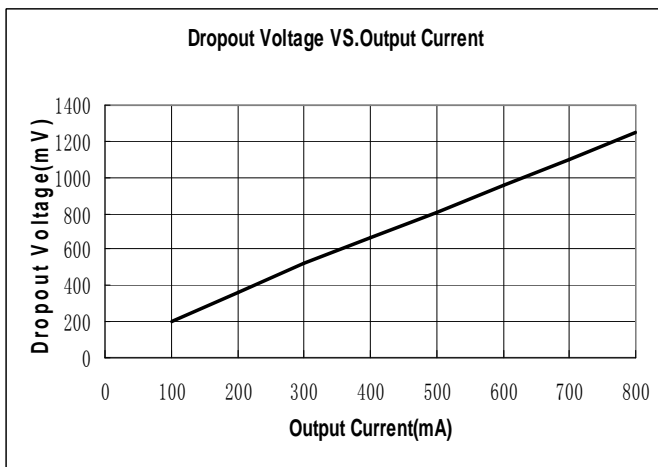

BL9118-1.8V

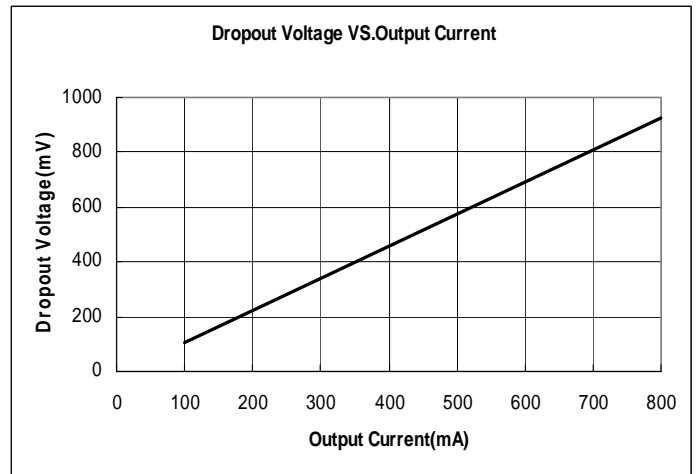

BL9118-2.5V

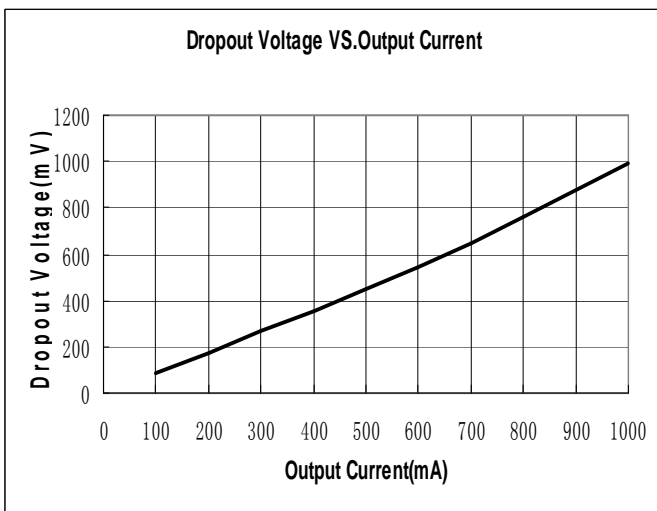

(4) Ripple Rejection vs. Frequency ($I_o=100\text{mA}$)

BL9118-1.2V

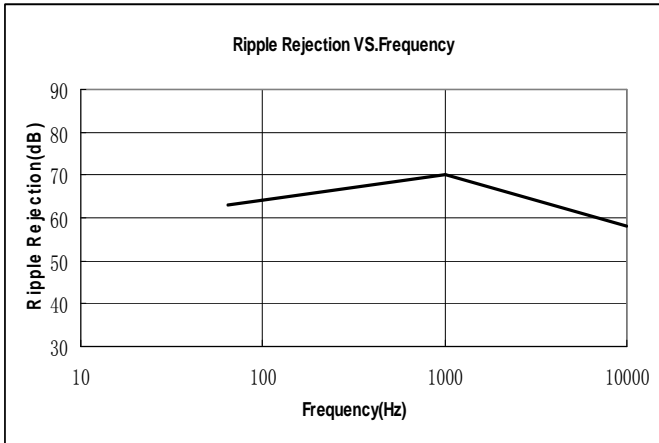

BL9118-1.8V

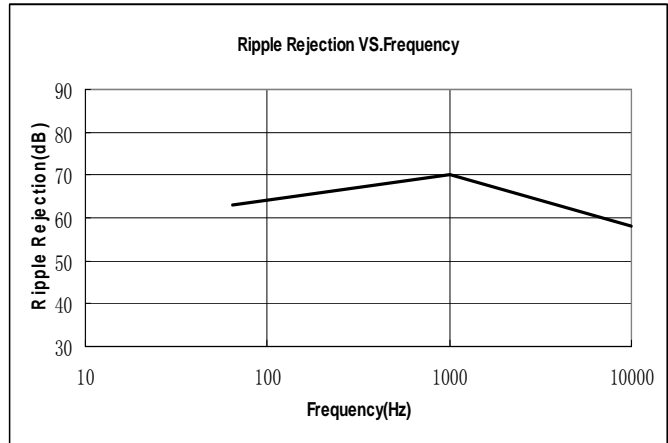

BL9118-2.5V

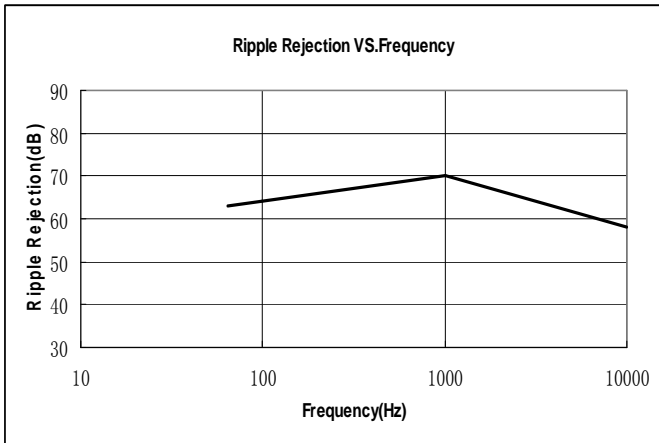

(5) Output Voltage VS. Input Voltage (Ta = 25 °C)

BL9118-1.2V

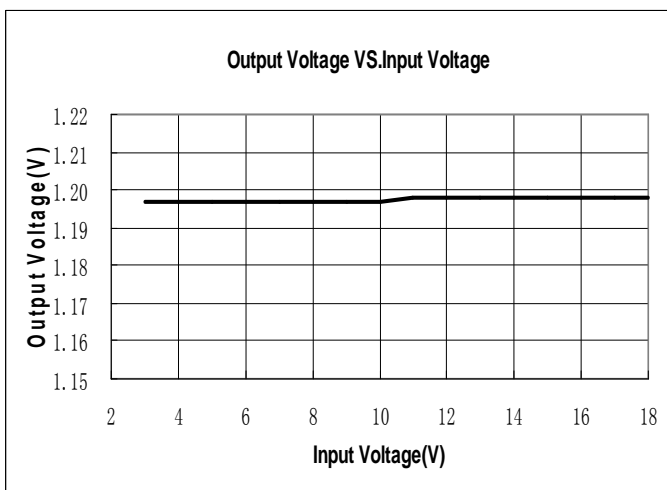

BL9118-1.8V

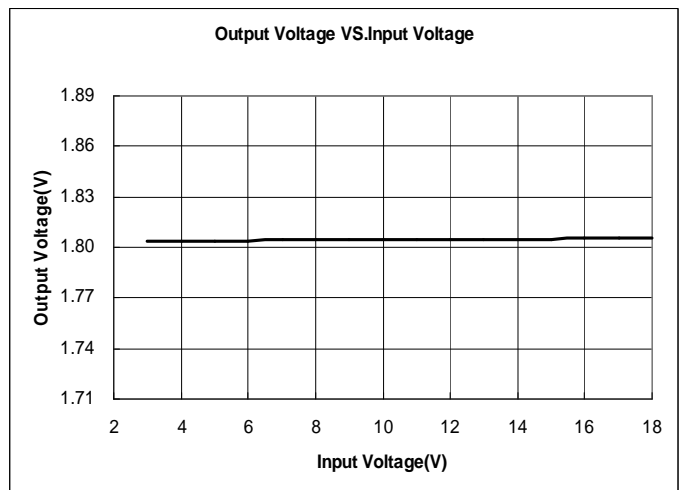

BL9118-2.5V

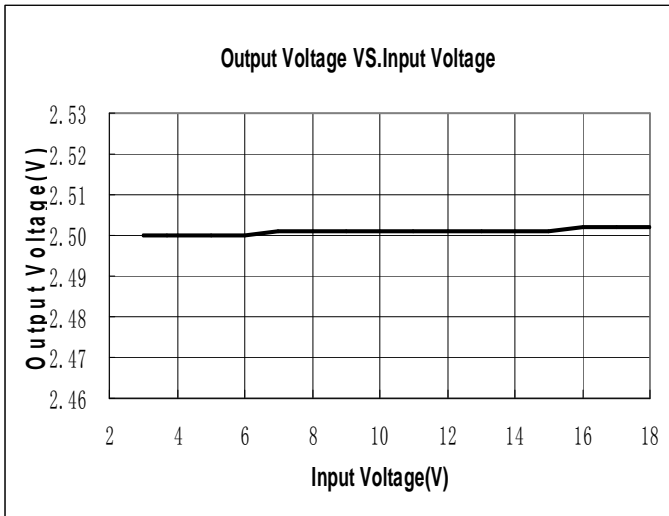

(6) Quiescent Current VS. Input Voltage

BL9118-1.2V

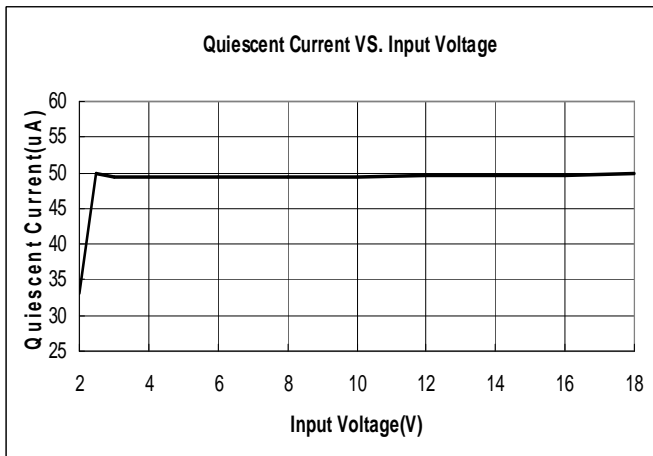

BL9118-1.8V

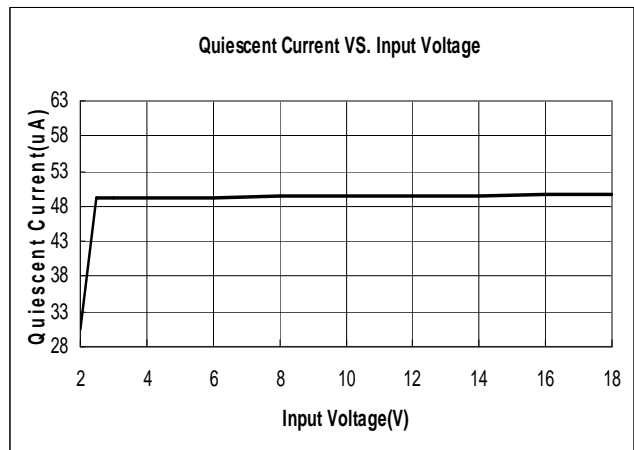

BL9118-2.5V

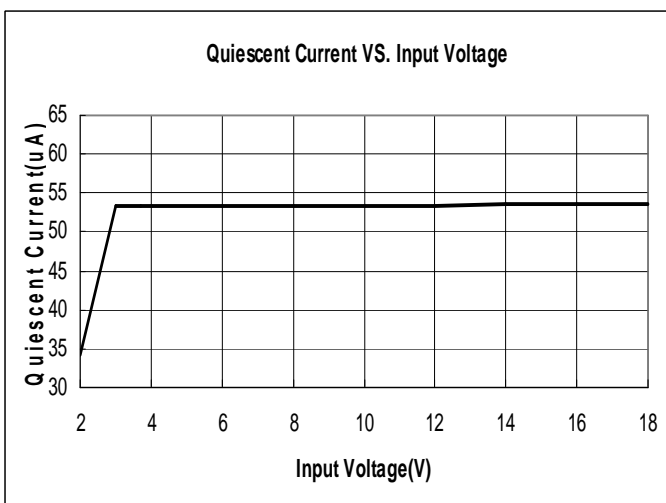

Applications Information

1. Input Bypass Capacitor

An input capacitor is recommended. A 10uF tantalum on the input is a suitable input bypassing for almost all applications.

2. Output Capacitor

The output capacitor is critical in maintaining regulator stability, and must meet the required conditions for both minimum amount of capacitance and ESR (Equivalent Series Resistance). The minimum output capacitance required by the BL9118 is 10μF, if a tantalum capacitor is used. Any increase of the output capacitance will merely improve the loop stability and transient response. The ESR of the output capacitor should be less than 0.5Ω.

3. Load Regulation

The BL9118 regulates the voltage that appears between its output and ground pins, or between its output and adjust pins. In some cases, line resistances can introduce errors to the voltage across the load. To obtain the best load regulation, a few precautions are needed. Figure 1, shows a typical application using a fixed output regulator. The R_{t1} and R_{t2} are the line resistances. It is obvious that the V_{LOAD} is less than the V_{OUT} by the sum of the voltage drops along the line resistances. In this case, the load regulation seen at the R_{LOAD} would be degraded from the datasheet specification. To improve this, the load should be tied directly to the output terminal on the positive side and directly tied to the ground terminal on the negative side.

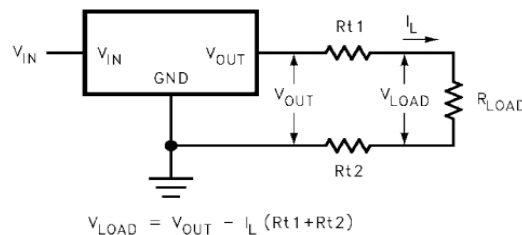
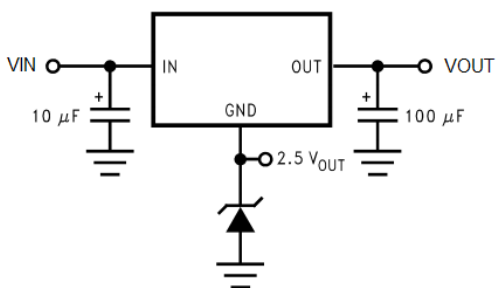

FIGURE 1. Typical Application using Fixed Output Regulator

Application Circuit

(1) Regulator with Reference



(2) Adjusting Output of Fixed Voltage Regulators

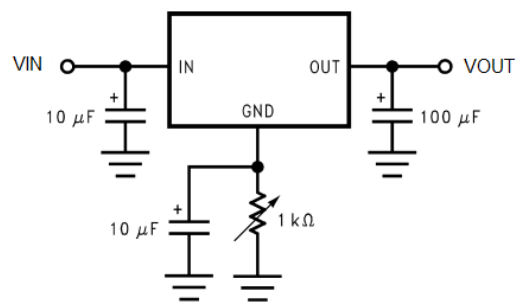

(3) Battery Backed-Up Power Supply

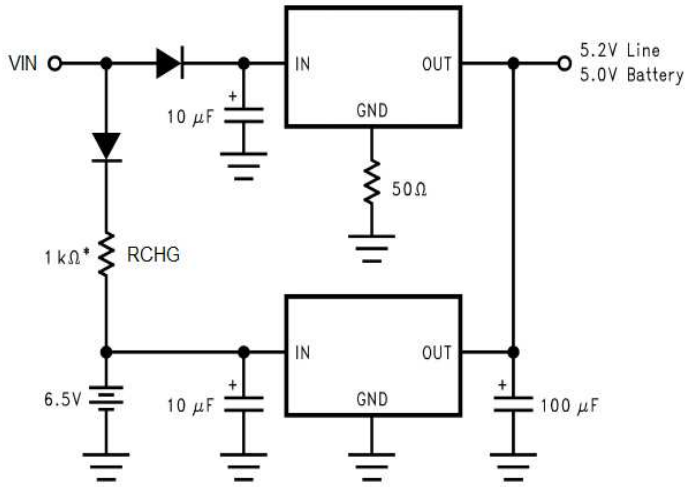

* Select for charge rate.

(4) Low Dropout Negative Supply

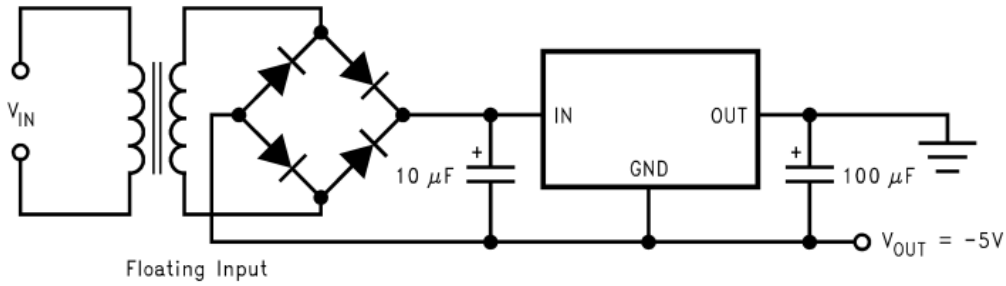

Packaging Information

- SOT223

